

VERKEHRSTECHNIK

- Verkehrszeichen
- Straßenausrüstung
- Baustellenabsicherung
- Park- und Leitsysteme
- Zubehör



BESCHILDERUNG

- Orts- und Regionalbeschilderung
- Leitsysteme

WIR FÜHREN NUR
GUTES IM SCHILDE.

INHALT

ALLGEMEINE INFORMATIONEN

Über uns.....	04
Verkehrstechnik & Beschilderung	05
Digitaldruckverfahren.....	06
Qualitätsstandards.....	07
Produktinformationen.....	08 - 09
Trägermaterial.....	10

VERKEHRSZEICHEN



■ Gefahrenzeichen.....	11 - 15
Vorschriftszeichen.....	16 - 27
Hinweiszeichen, Wegweiser, Autobahnbesch.....	28 - 72
Umleitungsbeschilderung.....	73 - 76
Zusatztafeln.....	77 - 79
Sondertafeln RVS.....	80 - 81
Sonstige Informationsschilder.....	82 - 85
Schutzwegsicherung.....	86

BEFESTIGUNGSSYSTEME

■ Laschen.....	87 - 92
Steher und Zubehör	93 - 101
I-Steher und Zubehör	102 - 103
Gitterrohrsteher und Zubehör.....	104 - 105
Rohrrahmen und Zubehör	106 - 117
Sonderrohrahmen für Leitsysteme.....	118 - 121

STRASSENBEZEICHNUNGSTAFELN HAUSNUMMERNTAFELN

■ Straßenbezeichnungstafeln und Zubehör	122 - 125
Hausnummerntafeln.....	126

LEITPFLÖCKE

■ Leitpflöcke und Zubehör.....	127 - 129
Schneestangen und Zubehör.....	130 - 131

VERKEHRS- UND BEOBACHTUNGSSPIEGEL

■ Übersicht Spiegeleigenschaften	132
Verkehrsspiegel	133
schlagfeste Spiegel.....	134
beschlags- und vereisungsfreie Spiegel.....	135
BIMEX Super Mirror Spiegel	136
Spiegel-Zubehör	137

ÜBERFAHRBARE ABSPERRPFOSTEN / POLLER



■ Allgemeine Infos.....	138 - 139
Fahrbahnpoller	140 - 141
Stadtpoller.....	142 - 144
Sonstige Poller	145 - 147
Poller-Zubehör.....	148
Vollgummi-Poller, Trenninsel, Trennbalken	149
Euronormkissen, Minikreissegmentschwelle.....	150
Parkplatzstopp, Elastikbordsteine.....	151 - 152

GESCHWINDIGKEITS- MESSGERÄTE

■ Geschwindigkeitsmessgeräte.....	153 - 154
Zubehör	155

INHALT

STRASSENZUBEHÖR	■	ABP-Reflektoren.....	156
		diverse Reflektoren.....	157
		Sonstiges Zubehör.....	158
STRASSENABSPERRUNGEN	■	Absperrpfosten.....	159 - 160
		Schrankensysteme.....	160
	■	FAHNEN U. FAHNENMASTE	161
BAUSTELLEN- UND SICHERHEITSPRODUKTE	■	Temporäre Verkehrszeichen.....	162 - 166
		Steher und Zubehör.....	167 - 168
		Anhaltevorrichtungen und Absperrungen.....	168 - 171
		Warnvorrichtungen.....	171
		Faltsignale.....	172
		Leitkegel.....	173
		Wendebaken.....	174
		Baustellenleuchten u. -ampeln.....	175
		LED-Lichtleitsysteme.....	176
		Spotanlagen, Lauflichtanlagen.....	177 - 178
		Klemmfix-Produkte.....	179
		Warnleitanhänger, Warnleitschwellen.....	180
	■	MARKIERUNGSFOLIEN	181
	■	WARN-, HINWEIS- UND UNFALLVERHÜTUNGSSCHILDER	182 - 190
	■	RAD-, FUSS- UND FITNESSBESCHILDERUNG	191
	■	OBJEKTBESCHILDERUNG	192
	■	LEITSYSTEME, SONSTIGE BESCHILDERUNG	193 - 200
	■	AGB	201 - 202
	■	QUALITÄTSMANAGEMENT MIT SYSTEM	203

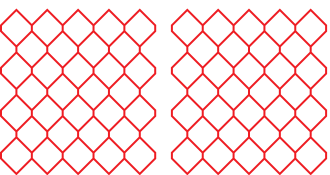

13.600

Produkte setzen Zeichen.

Die Firmengründer Elke und Karl Kaltenhauser und ihre bestens geschulten und hoch motivierten MitarbeiterInnen stehen ganz im Zeichen kompetenter Beratung und langjährigen Know-hows. Auch hinsichtlich der Unterstützung bei der Amtsabwicklung. Denn gerade dieser Bereich erfordert viel Erfahrung.

**Bei ITEK findet man die gesamte
Bandbreite an hochwertigster**

- Verkehrstechnik
 - Beschilderungstechnik
 - Objektbeschilderung und
 - Werbetechnik
- unter einem Dach in Grafenstein.

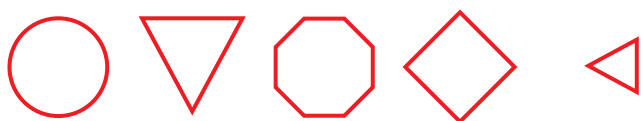

**ITEK VERKEHRS- UND
BESCHILDERUNGSTECHNIK GMBH**

St. Peter 33
9131 Grafenstein
Austria

T +43 4225/25 69
F +43 4225/25 69-14
office@itek.co.at
www.itek.co.at



ITEK VERKEHRSTECHNIK

Alles fließt.

Ganz im Zeichen modernster Technik:

- _ Verkehrszeichen
- _ Baustellenabsicherung
- _ Straßenausrüstung
- _ Park- und Leitsysteme
- _ Zubehör

Unser Produktportfolio im Bereich der Verkehrstechnik sorgt dafür, dass alles im Fluss ist. Denn die verschiedenen Bedeutungen, Ausführungen und Maße von Verkehrszeichen sind durch gesetzliche Regelungen und Normen bestimmt, über die wir selbstverständlich bestens informiert sind.

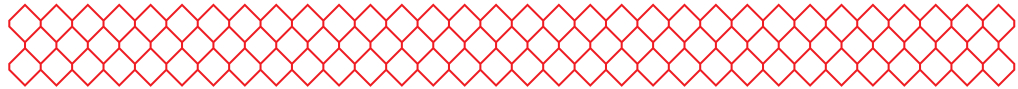

ITEK BESCHILDERUNG

Ihre Aushängeschilder.

Ihre verlässlichen Wegbegleiter:

- _ Orts- und Regionalbeschilderung
- _ Leitsysteme

Die Orts- und Regionalbeschilderung garantiert mit ihren UV-Beständigkeitsgarantien eine Haltbarkeitsdauer von bis zu 14 Jahren. Das in Österreich einzigartige Konzept begrüßt bei Ortsein- und -ausfahrten und informiert Radfahrer und Wanderer auf all ihren Wegen.

Die Objektbeschilderungen für innen und außen hinterlassen auf Türen, Gängen, Fluchtwegen, Pylonen, Fahnen, Gebäuden und Parkplätzen den besten Eindruck.

DIGITALDRUCK MACHT EINDRUCK.

Modern,
emissionsfrei,
umwelfreundlich.

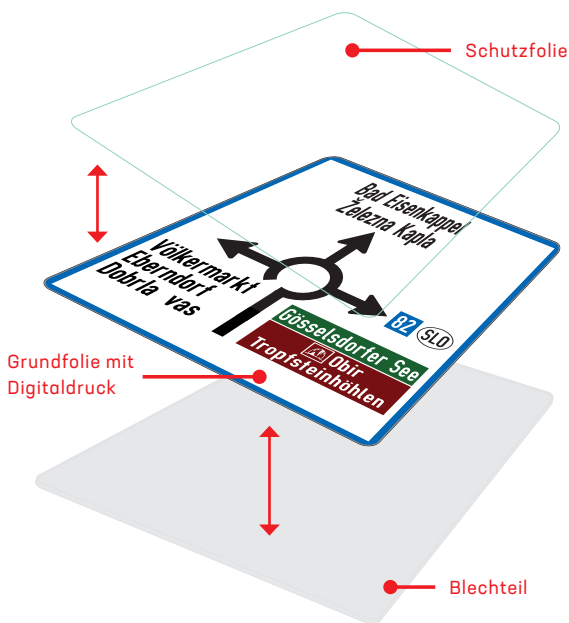

ITEK produziert die Verkehrszeichen als erster Verkehrszeichenhersteller bereits seit 2011 im Digitaldruck.

Im flexiblen Digitaldruckverfahren werden alle Farben in nur einem Arbeitsgang auf weiße, reflektierende Grundfolie gedruckt. Die Folie wird dann mit einem transparenten Schutzfilm überzogen. Anschließend wird die gesamte Folie auf den Aluminiumträger appliziert.

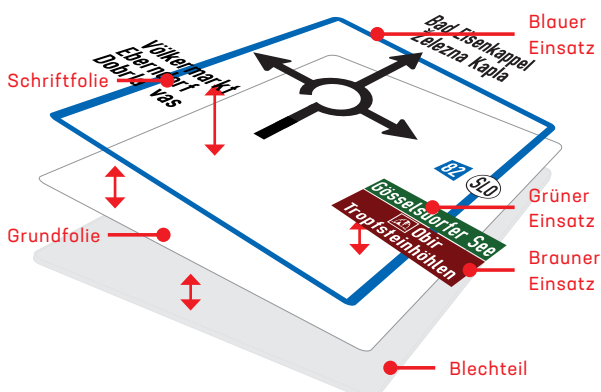

Mehrschichtiger Schilderwald war gestern.

Die herkömmliche Kombination von Folien und der mehrschichtige Aufbau bieten zahlreiche Angriffspunkte für Umwelt- und Witterungseinflüsse, die wir durch das nunmehr eingesetzte innovative Digitaldruckverfahren ausschalten können.



Mit äußerster Sorgfalt und Genauigkeit fährt man immer gut.



+ Umweltfreundliche Schilderwelt.

Das hochwertige, schadstofffreie Material widersteht aufgrund der geschlossenen Oberfläche, die mit dem 3M-Folien-Farb-System hergestellt wird, optimal sämtlichen Umweltbelastungen und Witterungseinflüssen und garantiert dadurch eine lange Lebensdauer.

+ Höchste Sicherheitsstandards.

Die Rückstrahlwerte und Farben entsprechen den gültigen Normen und Vorschriften, TÜV-geprüft und zertifiziert.

+ Maximale Individualität.

Auf Kundenwunsch können die Produkte auch in individuellen Formaten angefertigt werden.

+ Geprüfte Qualität.

Jedes Schild wird versehen mit dem Hersteller-, Bauart und CE-Aufkleber.

Unsere Leistungserklärungen können jederzeit auf unserer Website www.itek.co.at abgerufen werden!



PRODUKT- INFORMATIONEN



FOLIE TYPE 1

MICROPRISMATISCHE FOLIE
ENGINEER GRADE PRISMATIC (EGP) BZW.
ADVANCED ENGINEER GRADE (AEGP)

- **hochrückstrahlend**
- **7 + 3 Jahre** (zus. Garantieverlängerung)
Haltbarkeitsgarantie
- **Reflexfolie der Klasse RA 1 in mikrop Prismatischer Ausführung (Aufbau C)**

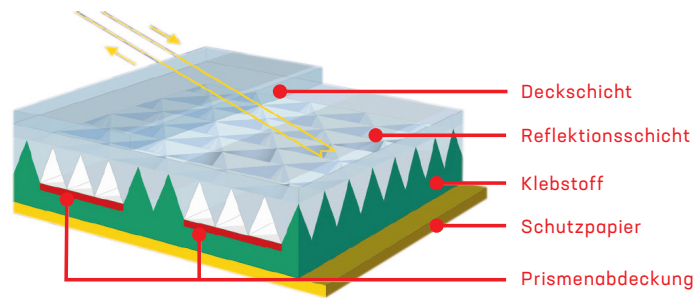

Die Weiterentwicklung der bereits in die Jahre gekommenen Engineer Grade Glasperlenfolie bietet eine bessere Tages- und Nachtsichtbarkeit durch ihre hellere Oberfläche und hat alle Vorteile einer mikrop Prismatischen Folie. Die Reflexion ist höher als bei Engineer Grade (EG), und niedriger als bei High Intensity Prismatic (HIP) - daher kann sie die Folie Type II nicht ersetzen.

EINSATZ:

Schwach befahrene Landesstraßen und verkehrsberuhigte Lagen mit geringer Ausleuchtung.

FOLIE TYPE 2

MICROPRISMATISCHE FOLIE
HIGH INTENSITY PRISMATIC (HIP)

- **hochrückstrahlend**
- **10 + 2 Jahre** (zus. Garantieverlängerung)
Haltbarkeitsgarantie
- **Retroreflexions-Klasse RA2, konstruktiver Aufbau C (RA2/C)**

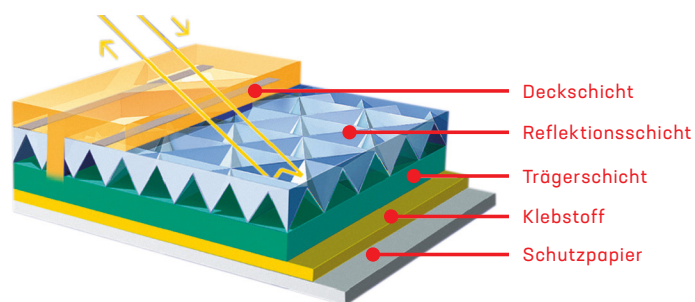

Die mikrop Prismatische Hochreflexfolie der vierten Generation auf der Basis von prismatischen Linsen weist gegenüber der Folienklasse 3 verminderte Reflexwerte auf.



3M™ MCS™ Warranty

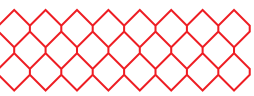

FOLIE TYPE 3

MICROPRISMATISCHE FOLIE
DIAMOND GRADE (DG3)

- **sehr hochrückstrahlend**
- **12 + 2 Jahre** (zus. Garantieverlängerung)
Haltbarkeitsgarantie
- **Retroreflektionsklasse RA3,**
konstruktiver Aufbau C
(RA3/C)

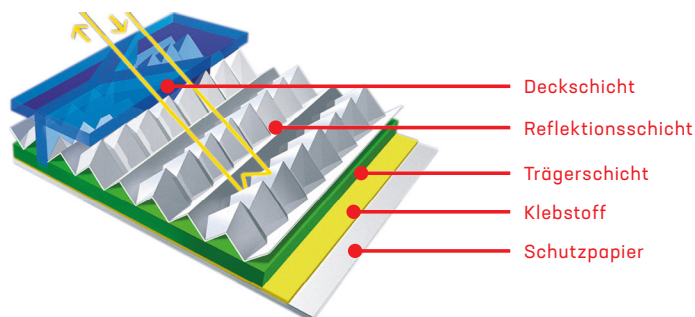

Die Mikroprismentechnologie ist ein Meilenstein für die Anforderungen der schnelleren und komplexeren Situationen im Straßenverkehr und bietet höchste Leistung.

EINSATZ:

Speziell entwickelt für den Einsatz auf Straßen mit hoher Geschwindigkeit, bei denen ein frühzeitiges Erkennen der Informationen für den Autofahrer wichtig ist. Hochleistungsfähige Mikroprismen werfen das Licht auf weite Entfernungen zurück, sodass Schilder mit 3M Diamond Grade Reflexfolie schon auf sehr große Distanzen wahrgenommen und erkannt werden können.

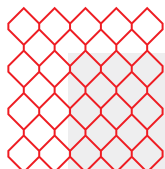

PROTECTIVE OVERLAY FILM

SCHUTZFILM 1140 UND 1170

Transparente Schutzfolie, als Schutz gegen die meisten Formen des Vandalismus - **ohne zusätzliche Mehrkosten**. Die Schutzfolie wird automatisch bei der Produktion von Verkehrszeichen im Digitaldruck aufgezogen. Die meisten Formen von Vandalismus, wie Graffiti und das Bekleben mit Werbeaufklebern können problemlos entfernt werden. Die Folien sind witterungs- und lösemittelbeständig.

EINSATZ:

3M Protective Overlay Film Serie 1140 und 1170 ist als hoch transparente Overlay Folie zum Schutz von 3M reflektierenden Folien entwickelt worden.



TRÄGERMATERIAL FÜR VERKEHRS- ZEICHEN



AUSFÜHRUNG FLACH

Aluminium Speziallegierung
Stärke 2, 2,5 oder 3 mm
Rückseite blendfrei



AUSFÜHRUNG FLACH - BAUSTELLEN- AUSFÜHRUNG

Aluminium Speziallegierung
Stärke 1,5 mm
Rückseite blendfrei

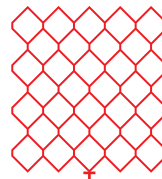

AUSFÜHRUNG FORMLINE

Aluminium Speziallegierung
Stärke 2 mm
Rückseite blendfrei
Durch die Form der Randver-
formung hohe Schilder-Sta-
bilität.



AUSFÜHRUNG UMRANDUNGSPROFIL ALFORM I

Aluminium Speziallegierung
Stärke 2, 2,5 oder 3 mm
Rückseite blendfrei
Durch die Umrandung sehr
hohe Schilder-Stabilität.



AUSFÜHRUNG UMRANDUNGSPROFIL ALFORM II UND III

Aluminium Speziallegierung
Stärke 3 mm
Rückseite blendfrei
Bei Tafelgrößen von 1,5 m² bis
ca. 3 m² wird Alform II verwen-
det. Ab ca. 3 m² Alform III.



VERPACKUNGS- UND TRANSPORT- HINWEIS









Die Verpackungs- und Trans-
porthinweise sind jeder
Lieferung beige packt.



GEFAHRENZEICHEN § 50	MASSE/ STÄRKE MM	AUSFÜHRUNG FLACH			AUSFÜHRUNG FORMLINE			AUSFÜHRUNG ALFORM		
		Folie EGP	Folie HIP	Folie DGV	Folie EGP	Folie HIP	Folie DGV	Folie EGP	Folie HIP	Folie DGV
		Type 1	Type 2	Type 3	Type 1	Type 2	Type 3	Type 1	Type 2	Type 3
Querrinne oder Aufwölbung § 50/1 	700/2	K50103 € 51,00	K50102 € 69,00	K50101 € 77,80	K50103F € 86,60	K50102F € 93,70	K50101F € 98,70	K50103U € 79,40	K50102U € 98,80	K50101U € 105,80
	1000/2,5	K50106 € 112,20	K50105 € 144,00	K50104 € 163,30	K50106F € 146,00	K50105F € 161,90	K50104F € 176,30	K50106U € 144,40	K50105U € 183,10	K50104U € 198,50
Rechtskurve § 50/2a 	700/2	K502A03 € 51,00	K502A02 € 69,00	K502A01 € 77,80	K502A03F € 86,60	K502A02F € 93,70	K502A01F € 98,70	K502A03U € 79,40	K502A02U € 98,80	K502A01U € 105,80
	1000/2,5	K502A06 € 112,20	K502A05 € 144,00	K502A04 € 163,30	K502A06F € 146,00	K502A05F € 161,90	K502A04F € 176,30	K502A06U € 144,40	K502A05U € 183,10	K502A04U € 198,50
	1500/3	K502A09 € 437,20	K502A08 € 534,20	K502A07 € 573,00				K502A09U € 497,70	K502A08U € 581,80	K502A07U € 633,50
Linkskurve § 50/2b 	700/2	K502B03 € 51,00	K502B02 € 69,00	K502B01 € 77,80	K502B03F € 86,60	K502B02F € 93,70	K502B01F € 98,70	K502B03U € 79,40	K502B02U € 98,80	K502B01U € 105,80
	1000/2,5	K502B06 € 112,20	K502B05 € 144,00	K502B04 € 163,30	K502B06F € 146,00	K502B05F € 161,90	K502B04F € 176,30	K502B06U € 144,40	K502B05U € 183,10	K502B04U € 198,50
	1500/3	K502B09 € 437,20	K502B08 € 534,20	K502B07 € 573,00				K502B09U € 497,70	K502B08U € 581,80	K502B07U € 633,50
Doppelkurve rechts beginnend § 50/2c 	700/2	K502C03 € 51,00	K502C02 € 69,00	K502C01 € 77,80	K502C03F € 86,60	K502C02F € 93,70	K502C01F € 98,70	K502C03U € 79,40	K502C02U € 98,80	K502C01U € 105,80
	1000/2,5	K502C06 € 112,20	K502C05 € 144,00	K502C04 € 163,30	K502C06F € 146,00	K502C05F € 161,90	K502C04F € 176,30	K502C06U € 144,40	K502C05U € 183,10	K502C04U € 198,50
	1500/3	K502C09 € 437,20	K502C08 € 534,20	K502C07 € 573,00				K502C09U € 497,70	K502C08U € 581,80	K502C07U € 633,50
Doppelkurve links beginnend § 50/2d 	700/2	K502D03 € 51,00	K502D02 € 69,00	K502D01 € 77,80	K502D03F € 86,60	K502D02F € 93,70	K502D01F € 98,70	K502D03U € 79,40	K502D02U € 98,80	K502D01U € 105,80
	1000/2,5	K502D06 € 112,20	K502D05 € 144,00	K502D04 € 163,30	K502D06F € 146,00	K502D05F € 161,90	K502D04F € 176,30	K502D06U € 144,40	K502D05U € 183,10	K502D04U € 198,50
	1500/3	K502D09 € 437,20	K502D08 € 534,20	K502D07 € 573,00				K502D09U € 497,70	K502D08U € 581,80	K502D07U € 633,50
Kreuzung § 50/3 	700/2	K50303 € 51,00	K50302 € 69,00	K50301 € 77,80	K50303F € 86,60	K50302F € 93,70	K50301F € 98,70	K50303U € 79,40	K50302U € 98,80	K50301U € 105,80
	1000/2,5	K50306 € 112,20	K50305 € 144,00	K50304 € 163,30	K50306F € 146,00	K50305F € 161,90	K50304F € 176,30	K50306U € 144,40	K50305U € 183,10	K50304U € 198,50
Kreuzung mit Kreisverkehr § 50/3a 	700/2	K503A03 € 51,00	K503A02 € 69,00	K503A01 € 77,80	K503A03F € 86,60	K503A02F € 93,70	K503A01F € 98,70	K503A03U € 79,40	K503A02U € 98,80	K503A01U € 105,80
	1000/2,5	K503A06 € 112,20	K503A05 € 144,00	K503A04 € 163,30	K503A06F € 146,00	K503A05F € 161,90	K503A04F € 176,30	K503A06U € 144,40	K503A05U € 183,10	K503A04U € 198,50
Kreuzung mit Straße ohne Vorrang § 50/4 	700/2	K50403 € 51,00	K50402 € 69,00	K50401 € 77,80	K50403F € 86,60	K50402F € 93,70	K50401F € 98,70	K50403U € 79,40	K50402U € 98,80	K50401U € 105,80
	1000/2,5	K50406 € 112,20	K50405 € 144,00	K50404 € 163,30	K50406F € 146,00	K50405F € 161,90	K50404F € 176,30	K50406U € 144,40	K50405U € 183,10	K50404U € 198,50
Bahnübergang mit Schranken § 50/6a 	700/2		K506A02 € 69,00	K506A01 € 77,80		K506A02F € 93,70	K506A01F € 98,70		K506A02U € 98,80	K506A01U € 105,80
	1000/2,5		K506A05 € 144,00	K506A04 € 163,30		K506A05F € 161,90	K506A04F € 176,30		K506A05U € 183,10	K506A04U € 198,50
Bahnübergang ohne Schranken § 50/6b 	700/2		K506B02 € 69,00	K506B01 € 77,80		K506B02F € 93,70	K506B01F € 98,70		K506B02U € 98,80	K506B01U € 105,80
	1000/2,5		K506B05 € 144,00	K506B04 € 163,30		K506B05F € 161,90	K506B04F € 176,30		K506B05U € 183,10	K506B04U € 198,50







VERKEHRSZEICHEN

GEFAHRENZEICHEN § 50	MASSE/ STÄRKE MM	AUSFÜHRUNG FLACH			AUSFÜHRUNG FORMLINE			AUSFÜHRUNG ALFORM		
		Folie EGP	Folie HIP	Folie DGV	Folie EGP	Folie HIP	Folie DGV	Folie EGP	Folie HIP	Folie DGV
		Type 1	Type 2	Type 3	Type 1	Type 2	Type 3	Type 1	Type 2	Type 3
Baken 80m § 50/6c 	310x960/2 links		K506C02 € 91,10	K506C01 € 126,30		K506C02F € 110,70	K506C01F € 142,80		K506C02U € 123,00	K506C01U € 159,90
	380x1200/2,5 links		K506C05 € 131,80	K506C04 € 149,30					K506C05U € 171,90	K506C04U € 185,90
	310x960/2 rechts		K506C08 € 91,10	K506C07 € 126,30		K506C08F € 110,70	K506C07F € 142,80		K506C08U € 123,00	K506C07U € 159,90
	380x1200/2,5 rechts		K506C11 € 131,80	K506C10 € 149,30					K506C11U € 171,90	K506C10U € 185,90
Baken 160m § 50/6c 	310x960/2 links		K506C14 € 91,10	K506C13 € 126,30		K506C14F € 110,70	K506C13F € 142,80		K506C14U € 123,00	K506C13U € 159,90
	380x1200/2,5 links		K506C17 € 131,80	K506C16 € 149,30					K506C17U € 171,90	K506C16U € 185,90
	310x960/2 rechts		K506C20 € 91,10	K506C19 € 126,30		K506C20F € 110,70	K506C19F € 142,80		K506C20U € 123,00	K506C19U € 159,90
	380x1200/2,5 rechts		K506C23 € 131,80	K506C22 € 149,30					K506C23U € 171,90	K506C22U € 185,90
Baken 240m § 50/6c 	310x960/2 links		K506C26 € 91,10	K506C25 € 126,30		K506C26F € 110,70	K506C25F € 142,80		K506C26U € 123,00	K506C25U € 159,90
	380x1200/2,5 links		K506C29 € 131,80	K506C28 € 149,30					K506C29U € 171,90	K506C28U € 185,90
	310x960/2 rechts		K506C32 € 91,10	K506C31 € 126,30		K506C32F € 110,70	K506C31F € 142,80		K506C32U € 123,00	K506C31U € 159,90
	380x1200/2,5 rechts		K506C35 € 131,80	K506C34 € 149,30					K506C35U € 171,90	K506C34U € 185,90
Andreaskreuz eingleisig § 50/6d  Tafel	630x960/2,5 Tafel		K506D05 € 205,30	K506D04 € 236,30		K506D05F € 263,50	K506D04F € 280,80		K506D05U € 243,30	K506D04U € 270,70
	750x1150/2,5 Tafel		K506D08 € 276,00	K506D07 € 319,10					K506D08U € 334,70	K506D07U € 382,90
Andreaskreuz mehrgleisig Anordnung waagrecht § 50/6d  Tafel	960x960/2,5 Tafel		K506D12 € 293,30	K506D11 € 365,20					K506D12U € 353,20	K506D11U € 415,50
Andreaskreuz mehrgleisig Anordnung senkrecht § 50/6d  Tafel	630x1400/3 Tafel		K506D17 € 401,70	K506D16 € 427,90					K506D17U € 488,70	K506D16U € 514,90
	750x1600/3 Tafel		K506D20 € 561,80	K506D19 € 621,80					K506D20U € 614,80	K506D19U € 675,80
Gefährliches Gefälle § 50/7  Prozente angeben!	700/2	K50703 € 51,00	K50702 € 69,00	K50701 € 77,80	K50703F € 86,60	K50702F € 93,70	K50701F € 98,70	K50703U € 79,40	K50702U € 98,80	K50701U € 105,80
	1000/2,5	K50706 € 112,20	K50705 € 144,00	K50704 € 163,30	K50706F € 146,00	K50705F € 161,90	K50704F € 176,30	K50706U € 144,40	K50705U € 183,10	K50704U € 198,50
Starke Steigung § 50/7a  Prozente angeben!	700/2	K507A03 € 51,00	K507A02 € 69,00	K507A01 € 77,80	K507A03F € 86,60	K507A02F € 93,70	K507A01F € 98,70	K507A03U € 79,40	K507A02U € 98,80	K507A01U € 105,80
	1000/2,5	K507A06 € 112,20	K507A05 € 144,00	K507A04 € 163,30	K507A06F € 146,00	K507A05F € 161,90	K507A04F € 176,30	K507A06U € 144,40	K507A05U € 183,10	K507A04U € 198,50

GEFAHRENZEICHEN § 50	MASSE/ STÄRKE MM	AUSFÜHRUNG FLACH			AUSFÜHRUNG FORMLINE			AUSFÜHRUNG ALFORM		
		Folie EGP	Folie HIP	Folie DGV	Folie EGP	Folie HIP	Folie DGV	Folie EGP	Folie HIP	Folie DGV
		Type 1	Type 2	Type 3	Type 1	Type 2	Type 3	Type 1	Type 2	Type 3
§ 50/8a Fahrbahnverengung beidseitig 	700/2	K508A03 € 51,00	K508A02 € 69,00	K508A01 € 77,80	K508A03F € 86,60	K508A02F € 93,70	K508A01F € 98,70	K508A03U € 79,40	K508A02U € 98,80	K508A01U € 105,80
	1000/2,5	K508A06 € 112,20	K508A05 € 144,00	K508A04 € 163,30	K508A06F € 146,00	K508A05F € 161,90	K508A04F € 176,30	K508A06U € 144,40	K508A05U € 183,10	K508A04U € 198,50
§ 50/8b Fahrbahnverengung linksseitig 	700/2	K508B03 € 51,00	K508B02 € 69,00	K508B01 € 77,80	K508B03F € 86,60	K508B02F € 93,70	K508B01F € 98,70	K508B03U € 79,40	K508B02U € 98,80	K508B01U € 105,80
	1000/2,5	K508B06 € 112,20	K508B05 € 144,00	K508B04 € 163,30	K508B06F € 146,00	K508B05F € 161,90	K508B04F € 176,30	K508B06U € 144,40	K508B05U € 183,10	K508B04U € 198,50
§ 50/8c Fahrbahnverengung rechtsseitig 	700/2	K508C03 € 51,00	K508C02 € 69,00	K508C01 € 77,80	K508C03F € 86,60	K508C02F € 93,70	K508C01F € 98,70	K508C03U € 79,40	K508C02U € 98,80	K508C01U € 105,80
	1000/2,5	K508C06 € 112,20	K508C05 € 144,00	K508C04 € 163,30	K508C06F € 146,00	K508C05F € 161,90	K508C04F € 176,30	K508C06U € 144,40	K508C05U € 183,10	K508C04U € 198,50
§ 50/9 Baustelle 	700/2	K50903 € 51,00	K50902 € 69,00	K50901 € 77,80	K50903F € 86,60	K50902F € 93,70	K50901F € 98,70	K50903U € 79,40	K50902U € 98,80	K50901U € 105,80
	1000/2,5	K50906 € 112,20	K50905 € 144,00	K50904 € 163,30	K50906F € 146,00	K50905F € 161,90	K50904F € 176,30	K50906U € 144,40	K50905U € 183,10	K50904U € 198,50
§ 50/10 Schleudergefahr 	700/2	K501003 € 51,00	K501002 € 69,00	K501001 € 77,80	K501003F € 86,60	K501002F € 93,70	K501001F € 98,70	K501003U € 79,40	K501002U € 98,80	K501001U € 105,80
	1000/2,5	K501006 € 112,20	K501005 € 144,00	K501004 € 163,30	K501006F € 146,00	K501005F € 161,90	K501004F € 176,30	K501006U € 144,40	K501005U € 183,10	K501004U € 198,50
	1500/3	K501009 € 437,20	K501008 € 534,20	K501007 € 573,00				K501009U € 437,70	K501008U € 581,80	K501007U € 633,50
§ 50/10a Seitenwind 	700/2	K5010A03 € 51,00	K5010A02 € 69,00	K5010A01 € 77,80	K5010A03F € 86,60	K5010A02F € 93,70	K5010A01F € 98,70	K5010A03U € 79,40	K5010A02U € 98,80	K5010A01U € 105,80
	1000/2,5	K5010A06 € 112,20	K5010A05 € 144,00	K5010A04 € 163,30	K5010A06F € 146,00	K5010A05F € 161,90	K5010A04F € 176,30	K5010A06U € 144,40	K5010A05U € 183,10	K5010A04U € 198,50
§ 50/10b Steinschlag 	700/2	K5010B03 € 51,00	K5010B02 € 69,00	K5010B01 € 77,80	K5010B03F € 86,60	K5010B02F € 93,70	K5010B01F € 98,70	K5010B03U € 79,40	K5010B02U € 98,80	K5010B01U € 105,80
	1000/2,5	K5010B06 € 112,20	K5010B05 € 144,00	K5010B04 € 163,30	K5010B06F € 146,00	K5010B05F € 161,90	K5010B04F € 176,30	K5010B06U € 144,40	K5010B05U € 183,10	K5010B04U € 198,50
§ 50/10c Flugbetrieb 	700/2	K5010C03 € 51,00	K5010C02 € 69,00	K5010C01 € 77,80	K5010C03F € 86,60	K5010C02F € 93,70	K5010C01F € 98,70	K5010C03U € 79,40	K5010C02U € 98,80	K5010C01U € 105,80
	1000/2,5	K5010C06 € 112,20	K5010C05 € 144,00	K5010C04 € 163,30	K5010C06F € 146,00	K5010C05F € 161,90	K5010C04F € 176,30	K5010C06U € 144,40	K5010C05U € 183,10	K5010C04U € 198,50
§ 50/11 Fußgängerübergang 	700/2		K501102 € 69,00	K501101 € 77,80		K501102F € 93,70	K501101F € 98,70		K501102U € 98,80	K501101U € 105,80
	1000/2,5		K501105 € 144,00	K501104 € 163,30		K501105F € 161,90	K501104F € 176,30		K501105U € 183,10	K501104U € 198,50
	1500/3		K501108 € 534,20	K501107 € 573,00					K501108U € 581,80	K501107U € 633,50
§ 50/11a Radfahrerüberfahrt 	700/2		K5011A02 € 69,00	K5011A01 € 77,80		K5011A02F € 93,70	K5011A01F € 98,70		K5011A02U € 98,80	K5011A01U € 105,80
	1000/2,5		K5011A05 € 144,00	K5011A04 € 163,30		K5011A05F € 161,90	K5011A04F € 176,30		K5011A05U € 183,10	K5011A04U € 198,50



VERKEHRSZEICHEN

GEFAHRENZEICHEN § 50	MASSE/ STÄRKE MM	AUSFÜHRUNG FLACH			AUSFÜHRUNG FORMLINE			AUSFÜHRUNG ALFORM		
		Folie EGP	Folie HIP	Folie DGV	Folie EGP	Folie HIP	Folie DGV	Folie EGP	Folie HIP	Folie DGV
		Type 1	Type 2	Type 3	Type 1	Type 2	Type 3	Type 1	Type 2	Type 3
Kinder § 50/12 	700/2		K501202 € 69,00	K501201 € 77,80		K501202F € 93,70	K501201F € 98,70		K501202U € 98,80	K501201U € 105,80
	1000/2,5		K501205 € 144,00	K501204 € 163,30		K501205F € 161,90	K501204F € 176,30		K501205U € 183,10	K501204U € 198,50
	1500/3		K501208 € 534,20	K501207 € 573,00					K501208U € 581,80	K501207U € 633,50
Achtung Tiere § 50/13a 	700/2	K5013A03 € 51,00	K5013A02 € 69,00	K5013A01 € 77,80	K5013A03F € 86,60	K5013A02F € 93,70	K5013A01F € 98,70	K5013A03U € 79,40	K5013A02U € 98,80	K5013A01U € 105,80
	1000/2,5	K5013A06 € 112,20	K5013A05 € 144,00	K5013A04 € 163,30	K5013A06F € 146,00	K5013A05F € 161,90	K5013A04F € 176,30	K5013A06U € 144,40	K5013A05U € 183,10	K5013A04U € 198,50
Achtung Wildwechsel § 50/13b 	700/2	K5013B03 € 51,00	K5013B02 € 69,00	K5013B01 € 77,80	K5013B03F € 86,60	K5013B02F € 93,70	K5013B01F € 98,70	K5013B03U € 79,40	K5013B02U € 98,80	K5013B01U € 105,80
	1000/2,5	K5013B06 € 112,20	K5013B05 € 144,00	K5013B04 € 163,30	K5013B06F € 146,00	K5013B05F € 161,90	K5013B04F € 176,30	K5013B06U € 144,40	K5013B05U € 183,10	K5013B04U € 198,50
Achtung Gegenverkehr § 50/14 	700/2	K501403 € 51,00	K501402 € 69,00	K501401 € 77,80	K501403F € 86,60	K501402F € 93,70	K501401F € 98,70	K501403U € 79,40	K501402U € 98,80	K501401U € 105,80
	1000/2,5	K501406 € 112,20	K501405 € 144,00	K501404 € 163,30	K501406F € 146,00	K501405F € 161,90	K501404F € 176,30	K501406U € 144,40	K501405U € 183,10	K501404U € 198,50
	1500/3	K501409 € 437,20	K501408 € 534,20	K501407 € 573,00				K501409U € 497,70	K501408U € 581,80	K501407U € 633,50
Achtung Falschfahrer § 50/14a 	700/2	K5014A03 € 51,00	K5014A02 € 69,00	K5014A01 € 77,80	K5014A03F € 86,60	K5014A02F € 93,70	K5014A01F € 98,70	K5014A03U € 79,40	K5014A02U € 98,80	K5014A01U € 105,80
	1000/2,5	K5014A06 € 112,20	K5014A05 € 144,00	K5014A04 € 163,30	K5014A06F € 146,00	K5014A05F € 161,90	K5014A04F € 176,30	K5014A06U € 144,40	K5014A05U € 183,10	K5014A04U € 198,50
	1500/3	K5014A09 € 437,20	K5014A08 € 534,20	K5014A07 € 573,00				K5014A09U € 497,70	K5014A08U € 581,80	K5014A07U € 633,50
Vorankündigung e. Lichtzeichens § 50/15 	700/2	K501503 € 51,00	K501502 € 69,00	K501501 € 77,80	K501503F € 86,60	K501502F € 93,70	K501501F € 98,70	K501503U € 79,40	K501502U € 98,80	K501501U € 105,80
	1000/2,5	K501506 € 112,20	K501505 € 144,00	K501504 € 163,30	K501506F € 146,00	K501505F € 161,90	K501504F € 176,30	K501506U € 144,40	K501505U € 183,10	K501504U € 198,50
Andere Gefahren § 50/16 	700/2	K501603 € 51,00	K501602 € 69,00	K501601 € 77,80	K501603F € 86,60	K501602F € 93,70	K501601F € 98,70	K501603U € 79,40	K501602U € 98,80	K501601U € 105,80
	1000/2,5	K501606 € 112,20	K501605 € 144,00	K501604 € 163,30	K501606F € 146,00	K501605F € 161,90	K501604F € 176,30	K501606U € 144,40	K501605U € 183,10	K501604U € 198,50



SCHILDER VON WELT MIT UMWELTEFFEKT.

ITEK



GEFAHRENZEICHEN § 50	MASSE/ STÄRKE MM	AUSFÜHRUNG FLACH			AUSFÜHRUNG FORMLINE			AUSFÜHRUNG ALFORM		
		Folie EGP	Folie HIP	Folie DGV	Folie EGP	Folie HIP	Folie DGV	Folie EGP	Folie HIP	Folie DGV
		Type 1	Type 2	Type 3	Type 1	Type 2	Type 3	Type 1	Type 2	Type 3
Sondertafeln										
Sondertafel § 50  Bitte Text und Symbol angeben! Hintergrund: zitronengelb	470x630/2	S501203 € 85,80	S501202 € 102,10	S501201 € 114,50	S501203F € 110,50	S501202F € 119,30	S501201F € 141,20	S501203U € 107,90	S501202U € 128,90	S501201U € 143,10
	630x960/2,5	S501206 € 162,80	S501205 € 205,30	S501204 € 236,30	S501206F € 192,90	S501205F € 263,50	S501204F € 280,80	S501206U € 194,40	S501205U € 243,30	S501204U € 270,70
	730x1000/2,5	S501209 € 264,90	S501208 € 318,70	S501207 € 340,20				S501209U € 371,50	S501208U € 425,30	S501207U € 446,80
	1000x1500/3	S501212 € 378,90	S501211 € 519,80	S501210 € 597,30				S501212U € 432,30	S501211U € 565,40	S501210U € 647,40

Aufpreis pro Symbol: € 15,00 Aufpreis pro Textzeile: € 10,00

Ausführung mit fluoreszierendem Hintergrund (nur in Folie Type 3 möglich!)	470x630/2		S501201N € 271,50		S501201NF € 399,60		S501201NU € 332,90
	630x960/2,5		S501204N € 463,90		S501204NF € 564,00		S501204NU € 546,00
	730x1000/2,5		S501207N € 531,90				S501207NU € 617,20
	1000x1500/3		S501210N € 1.127,50				S501210NU € 1.211,70

Aufpreis pro Symbol: € 15,00 Aufpreis pro Textzeile: € 10,00

Auf folgende Standardschilder gelten die Grundpreise:



AUSFÜHRUNG MIT LEDS:



Preis auf Anfrage



STROMUNABHÄNGIG MIT SOLAR-LEDS:

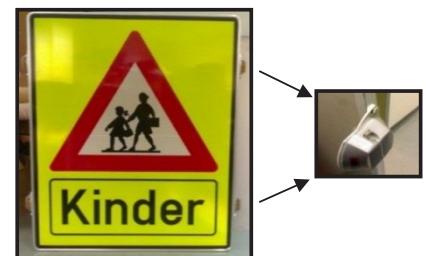







Preis auf Anfrage

DIGITALDRUCK MACHT EINDRUCK.

ITEK





VERKEHRSZEICHEN







VORSCHRIFTSZEICHEN § 52	MASSE/ STÄRKE MM	AUSFÜHRUNG FLACH			AUSFÜHRUNG FORMLINE			AUSFÜHRUNG ALFORM		
		Folie EGP Type 1	Folie HIP Type 2	Folie DGV Type 3	Folie EGP Type 1	Folie HIP Type 2	Folie DGV Type 3	Folie EGP Type 1	Folie HIP Type 2	Folie DGV Type 3
§ 52 Verkehrszeichen c) Vorrangzeichen										
Vorrang geben § 52/23 	700/2		K522302 € 63,10	K522301 € 73,30		K522302F € 93,70	K522301F € 98,70		K522302U € 88,30	K522301U € 102,10
	1000/2,5		K522305 € 130,50	K522304 € 158,50		K522305F € 161,90	K522304F € 176,30		K522305U € 170,40	K522304U € 191,90
	1500/3		K522308 € 695,20	K522307 € 744,00					K522308U € 581,80	K522307U € 633,50
Halt § 52/24 	630x630/2		K522402 € 103,20	K522401 € 136,00		K522402F € 185,30	K522401F € 194,40		K522402U € 141,10	K522401U € 169,30
	940x940/2,5		K522405 € 244,00	K522404 € 302,30		K522405F € 268,30	K522404F € 302,70		K522405U € 305,30	K522404U € 342,30
	1160x1160/3		K522408 € 526,20	K522407 € 492,00					K522408U € 610,10	K522407U € 646,20
Vorrangstraße § 52/25a 	470x470/2	K5225A03 € 50,10	K5225A02 € 70,20	K5225A01 € 86,70	K5225A03F € 93,80	K5225A02F € 100,60	K5225A01F € 105,80	K5225A03U € 86,20	K5225A02U € 106,00	K5225A01U € 125,50
	630x630/2	K5225A06 € 84,30	K5225A05 € 118,80	K5225A04 € 141,90	K5225A06F € 173,50	K5225A05F € 185,30	K5225A04F € 194,40	K5225A06U € 120,60	K5225A05U € 156,80	K5225A04U € 191,10
	960x960/2,5	K5225A09 € 203,30	K5225A08 € 293,30	K5225A07 € 365,20				K5225A09U € 252,50	K5225A08U € 353,20	K5225A07U € 415,50
Ende der Vorrangstraße § 52/25b 	470x470/2	K5225B03 € 50,10	K5225B02 € 70,20	K5225B01 € 86,70	K5225B03F € 93,80	K5225B02F € 100,60	K5225B01F € 105,80	K5225B03U € 86,20	K5225B02U € 106,00	K5225B01U € 125,50
	630x630/2	K5225B06 € 84,30	K5225B05 € 118,80	K5225B04 € 141,90	K5225B06F € 173,50	K5225B05F € 185,30	K5225B04F € 194,40	K5225B06U € 120,60	K5225B05U € 156,80	K5225B04U € 191,10
	960x960/2,5	K5225B09 € 203,30	K5225B08 € 293,30	K5225B07 € 365,20				K5225B09U € 252,50	K5225B08U € 353,20	K5225B07U € 415,50
§ 52 Verkehrszeichen a) Verbots- oder Beschränkungszeichen										
Fahrverbot in beide Richtungen § 52/1 	480/2	K52103 € 37,30	K52102 € 56,60	K52101 € 75,40	K52103F € 58,30	K52102F € 74,00	K52101F € 92,70	K52103U € 59,00	K52102U € 77,70	K52101U € 96,10
	670/2	K52106 € 76,00	K52105 € 109,00	K52104 € 137,30	K52106F € 116,90	K52105F € 128,50	K52104F € 164,00	K52106U € 106,30	K52105U € 140,00	K52104U € 162,40
	960/2,5	K52109 € 166,00	K52108 € 249,90	K52107 € 304,60	K52109F € 229,30	K52108F € 291,70	K52107F € 329,20	K52109U € 200,20	K52108U € 285,90	K52107U € 339,90
	1200/3	K52112 € 401,40	K52111 € 554,90	K52110 € 593,30				K52112U € 529,20	K52111U € 625,30	K52110U € 663,80
Einfahrt verboten § 52/2 	480/2		K52202 € 61,90	K52201 € 77,30		K52202F € 74,00	K52201F € 92,70		K52202U € 83,70	K52201U € 102,50
	670/2		K52205 € 115,20	K52204 € 140,90		K52205F € 128,50	K52204F € 164,00		K52205U € 144,70	K52204U € 172,50
	960/2,5		K52208 € 263,80	K52207 € 312,00		K52208F € 291,70	K52207F € 329,20		K52208U € 295,20	K52207U € 359,30
	1200/3		K52211 € 554,90	K52210 € 593,30					K52211U € 625,30	K52210U € 663,80
Einbiegen nach links verboten § 52/3a 	480/2	K523A03 € 42,40	K523A02 € 61,90	K523A01 € 77,30	K523A03F € 58,30	K523A02F € 74,00	K523A01F € 92,70	K523A03U € 67,10	K523A02U € 83,70	K523A01U € 102,50
	670/2	K523A06 € 81,10	K523A05 € 115,20	K523A04 € 140,90	K523A06F € 116,90	K523A05F € 128,50	K523A04F € 164,00	K523A06U € 108,30	K523A05U € 144,70	K523A04U € 172,50
	960/2,5	K523A09 € 171,70	K523A08 € 263,80	K523A07 € 312,00	K523A09F € 229,30	K523A08F € 291,70	K523A07F € 329,20	K523A09U € 208,20	K523A08U € 295,20	K523A07U € 359,30

VORSCHRIFTSZEICHEN § 52	MASSE/ STÄRKE MM	AUSFÜHRUNG FLACH			AUSFÜHRUNG FORMLINE			AUSFÜHRUNG ALFORM		
		Folie EGP	Folie HIP	Folie DGV	Folie EGP	Folie HIP	Folie DGV	Folie EGP	Folie HIP	Folie DGV
		Type 1	Type 2	Type 3	Type 1	Type 2	Type 3	Type 1	Type 2	Type 3
Einbiegen nach rechts verboten § 52/3b 	480/2	K523B03 € 42,40	K523B02 € 61,90	K523B01 € 77,30	K523B03F € 58,30	K523B02F € 74,00	K523B01F € 92,70	K523B03U € 67,10	K523B02U € 83,70	K523B01U € 102,50
	670/2	K523B06 € 81,10	K523B05 € 115,20	K523B04 € 140,90	K523B06F € 116,90	K523B05F € 128,50	K523B04F € 164,00	K523B06U € 108,30	K523B05U € 144,70	K523B04U € 172,50
	960/2,5	K523B09 € 171,70	K523B08 € 263,80	K523B07 € 312,00	K523B09F € 229,30	K523B08F € 291,70	K523B07F € 329,20	K523B09U € 208,20	K523B08U € 295,20	K523B07U € 359,30
Umkehren verboten § 52/3c 	480/2	K523C03 € 42,40	K523C02 € 61,90	K523C01 € 77,30	K523C03F € 58,30	K523C02F € 74,00	K523C01F € 92,70	K523C03U € 67,10	K523C02U € 83,70	K523C01U € 102,50
	670/2	K523C06 € 81,10	K523C05 € 115,20	K523C04 € 140,90	K523C06F € 116,90	K523C05F € 128,50	K523C04F € 164,00	K523C06U € 108,30	K523C05U € 144,70	K523C04U € 172,50
	960/2,5	K523C09 € 171,70	K523C08 € 263,80	K523C07 € 312,00	K523C09F € 229,30	K523C08F € 291,70	K523C07F € 329,20	K523C09U € 208,20	K523C08U € 295,20	K523C07U € 359,30
Überholen verboten § 52/4a 	480/2		K524A02 € 61,90	K524A01 € 77,30		K524A02F € 74,00	K524A01F € 92,70		K524A02U € 83,70	K524A01U € 102,50
	670/2		K524A05 € 115,20	K524A04 € 140,90		K524A05F € 128,50	K524A04F € 164,00		K524A05U € 144,70	K524A04U € 172,50
	960/2,5		K524A08 € 263,80	K524A07 € 312,00		K524A08F € 291,70	K524A07F € 329,20		K524A08U € 295,20	K524A07U € 359,30
	1200/3		K524A11 € 554,90	K524A10 € 593,30					K524A11U € 625,30	K524A10U € 663,80
Ende des Überholverbotes § 52/4b 	480/2	K524B03 € 42,40	K524B02 € 61,90	K524B01 € 77,30	K524B03F € 58,30	K524B02F € 74,00	K524B01F € 92,70	K524B03U € 67,10	K524B02U € 83,70	K524B01U € 102,50
	670/2	K524B06 € 81,10	K524B05 € 115,20	K524B04 € 140,90	K524B06F € 116,90	K524B05F € 128,50	K524B04F € 164,00	K524B06U € 108,30	K524B05U € 144,70	K524B04U € 172,50
	960/2,5	K524B09 € 171,70	K524B08 € 263,80	K524B07 € 312,00	K524B09F € 229,30	K524B08F € 291,70	K524B07F € 329,20	K524B09U € 208,20	K524B08U € 295,20	K524B07U € 359,30
Überholen für Lastkraftfahrzeuge verboten § 52/4c 	480/2		K524C02 € 61,90	K524C01 € 77,30		K524C02F € 74,00	K524C01F € 92,70		K524C02U € 83,70	K524C01U € 102,50
	670/2		K524C05 € 115,20	K524C04 € 140,90		K524C05F € 128,50	K524C04F € 164,00		K524C05U € 144,70	K524C04U € 172,50
	960/2,5		K524C08 € 263,80	K524C07 € 312,00		K524C08F € 291,70	K524C07F € 329,20		K524C08U € 295,20	K524C07U € 359,30
Ende des Überholverbotes für Lastkraftfahrzeuge § 52/4d 	480/2	K524D03 € 42,40	K524D02 € 61,90	K524D01 € 77,30	K524D03F € 58,30	K524D02F € 74,00	K524D01F € 92,70	K524D03U € 67,10	K524D02U € 83,70	K524D01U € 102,50
	670/2	K524D06 € 81,10	K524D05 € 115,20	K524D04 € 140,90	K524D06F € 116,90	K524D05F € 128,50	K524D04F € 164,00	K524D06U € 108,30	K524D05U € 144,70	K524D04U € 172,50
	960/2,5	K524D09 € 171,70	K524D08 € 263,80	K524D07 € 312,00	K524D09F € 229,30	K524D08F € 291,70	K524D07F € 329,20	K524D09U € 208,20	K524D08U € 295,20	K524D07U € 359,30
Wartepflicht bei Gegenverkehr § 52/5 	480/2	K52503 € 42,40	K52502 € 61,90	K52501 € 77,30	K52503F € 58,30	K52502F € 74,00	K52501F € 92,70	K52503U € 67,10	K52502U € 83,70	K52501U € 102,50
	670/2	K52506 € 81,10	K52505 € 115,20	K52504 € 140,90	K52506F € 116,90	K52505F € 128,50	K52504F € 164,00	K52506U € 108,30	K52505U € 144,70	K52504U € 172,50
	960/2,5	K52509 € 171,70	K52508 € 263,80	K52507 € 312,00	K52509F € 229,30	K52508F € 291,70	K52507F € 329,20	K52509U € 208,20	K52508U € 295,20	K52507U € 359,30









VERKEHRSZEICHEN







VORSCHRIFTSZEICHEN § 52	MASSE/ STÄRKE MM	AUSFÜHRUNG FLACH			AUSFÜHRUNG FORMLINE			AUSFÜHRUNG ALFORM		
		Folie EGP	Folie HIP	Folie DGV	Folie EGP	Folie HIP	Folie DGV	Folie EGP	Folie HIP	Folie DGV
		Type 1	Type 2	Type 3	Type 1	Type 2	Type 3	Type 1	Type 2	Type 3
Fahrverbot für alle Kraftfahrzeuge außer einspurigen Motorrädern § 52/6a 	480/2	K526A03 € 42,40	K526A02 € 61,90	K526A01 € 77,30	K526A03F € 58,30	K526A02F € 74,00	K526A01F € 92,70	K526A03U € 67,10	K526A02U € 83,70	K526A01U € 102,50
	670/2	K526A06 € 81,10	K526A05 € 115,20	K526A04 € 140,90	K526A06F € 116,90	K526A05F € 128,50	K526A04F € 164,00	K526A06U € 108,30	K526A05U € 144,70	K526A04U € 172,50
	960/2,5	K526A09 € 171,70	K526A08 € 263,80	K526A07 € 312,00	K526A09F € 229,30	K526A08F € 291,70	K526A07F € 329,20	K526A09U € 208,20	K526A08U € 295,20	K526A07U € 359,30
Fahrverbot für Motorräder § 52/6b 	480/2	K526B03 € 42,40	K526B02 € 61,90	K526B01 € 77,30	K526B03F € 58,30	K526B02F € 74,00	K526B01F € 92,70	K526B03U € 67,10	K526B02U € 83,70	K526B01U € 102,50
	670/2	K526B06 € 81,10	K526B05 € 115,20	K526B04 € 140,90	K526B06F € 116,90	K526B05F € 128,50	K526B04F € 164,00	K526B06U € 108,30	K526B05U € 144,70	K526B04U € 172,50
	960/2,5	K526B09 € 171,70	K526B08 € 263,80	K526B07 € 312,00	K526B09F € 229,30	K526B08F € 291,70	K526B07F € 329,20	K526B09U € 208,20	K526B08U € 295,20	K526B07U € 359,30
Fahrverbot für alle Kraftfahrzeuge § 52/6c 	480/2	K526C03 € 42,40	K526C02 € 61,90	K526C01 € 77,30	K526C03F € 58,30	K526C02F € 74,00	K526C01F € 92,70	K526C03U € 67,10	K526C02U € 83,70	K526C01U € 102,50
	670/2	K526C06 € 81,10	K526C05 € 115,20	K526C04 € 140,90	K526C06F € 116,90	K526C05F € 128,50	K526C04F € 164,00	K526C06U € 108,30	K526C05U € 144,70	K526C04U € 172,50
	960/2,5	K526C09 € 171,70	K526C08 € 263,80	K526C07 € 312,00	K526C09F € 229,30	K526C08F € 291,70	K526C07F € 329,20	K526C09U € 208,20	K526C08U € 295,20	K526C07U € 359,30
Fahrverbot für Kraftfahrzeuge mit Anhänger § 52/6d 	480/2	K526D03 € 42,40	K526D02 € 61,90	K526D01 € 77,30	K526D03F € 58,30	K526D02F € 74,00	K526D01F € 92,70	K526D03U € 67,10	K526D02U € 83,70	K526D01U € 102,50
	670/2	K526D06 € 81,10	K526D05 € 115,20	K526D04 € 140,90	K526D06F € 116,90	K526D05F € 128,50	K526D04F € 164,00	K526D06U € 108,30	K526D05U € 144,70	K526D04U € 172,50
	960/2,5	K526D09 € 171,70	K526D08 € 263,80	K526D07 € 312,00	K526D09F € 229,30	K526D08F € 291,70	K526D07F € 329,20	K526D09U € 208,20	K526D08U € 295,20	K526D07U € 359,30
Fahrverbot für Lastkraftfahrzeuge § 52/7a 	480/2	K527A03 € 42,40	K527A02 € 61,90	K527A01 € 77,30	K527A03F € 58,30	K527A02F € 74,00	K527A01F € 92,70	K527A03U € 67,10	K527A02U € 83,70	K527A01U € 102,50
	670/2	K527A06 € 81,10	K527A05 € 115,20	K527A04 € 140,90	K527A06F € 116,90	K527A05F € 128,50	K527A04F € 164,00	K527A06U € 108,30	K527A05U € 144,70	K527A04U € 172,50
	960/2,5	K527A09 € 171,70	K527A08 € 263,80	K527A07 € 312,00	K527A09F € 229,30	K527A08F € 291,70	K527A07F € 329,20	K527A09U € 208,20	K527A08U € 295,20	K527A07U € 359,30
Fahrverbot für Lastkraftfahrzeuge mit Gewichtsangabe § 52/7a 	480/2	K527A15 € 42,40	K527A14 € 61,90	K527A13 € 77,30	K527A15F € 58,30	K527A14F € 74,00	K527A13F € 92,70	K527A15U € 67,10	K527A14U € 83,70	K527A13U € 102,50
	670/2	K527A18 € 81,10	K527A17 € 115,20	K527A16 € 140,90	K527A18F € 116,90	K527A17F € 128,50	K527A16F € 164,00	K527A18U € 108,30	K527A17U € 144,70	K527A16U € 172,50
	960/2,5	K527A21 € 171,70	K527A20 € 263,80	K527A19 € 312,00	K527A21F € 229,30	K527A20F € 291,70	K527A19F € 329,20	K527A21U € 208,20	K527A20U € 295,20	K527A19U € 359,30
Fahrverbot für Lastkraftfahrzeuge mit Längenangabe § 52/7a 	480/2	K527A27 € 42,40	K527A26 € 61,90	K527A25 € 77,30	K527A27F € 58,30	K527A26F € 74,00	K527A25F € 92,70	K527A27U € 67,10	K527A26U € 83,70	K527A25U € 102,50
	670/2	K527A30 € 81,10	K527A29 € 115,20	K527A28 € 140,90	K527A30F € 116,90	K527A29F € 128,50	K527A28F € 164,00	K527A30U € 108,30	K527A29U € 144,70	K527A28U € 172,50
	960/2,5	K527A33 € 171,70	K527A32 € 263,80	K527A31 € 312,00	K527A33F € 229,30	K527A32F € 291,70	K527A31F € 329,20	K527A33U € 208,20	K527A32U € 295,20	K527A31U € 359,30

VORSCHRIFTSZEICHEN § 52	MASSE/ STÄRKE MM	AUSFÜHRUNG FLACH			AUSFÜHRUNG FORMLINE			AUSFÜHRUNG ALFORM		
		Folie EGP Type 1	Folie HIP Type 2	Folie DGV Type 3	Folie EGP Type 1	Folie HIP Type 2	Folie DGV Type 3	Folie EGP Type 1	Folie HIP Type 2	Folie DGV Type 3
Fahrverbot für Lastkraftfahrzeuge mit Anhängern § 52/7b 	480/2	K527B03	K527B02	K527B01	K527B03F	K527B02F	K527B01F	K527B03U	K527B02U	K527B01U
		€ 42,40	€ 61,90	€ 77,30	€ 58,30	€ 74,00	€ 92,70	€ 67,10	€ 83,70	€ 102,50
	670/2	K527B06	K527B05	K527B04	K527B06F	K527B05F	K527B04F	K527B06U	K527B05U	K527B04U
		€ 81,10	€ 115,20	€ 140,90	€ 116,90	€ 128,50	€ 164,00	€ 108,30	€ 144,70	€ 172,50
	960/2,5	K527B09	K527B08	K527B07	K527B09F	K527B08F	K527B07F	K527B09U	K527B08U	K527B07U
		€ 171,70	€ 263,80	€ 312,00	€ 229,30	€ 291,70	€ 329,20	€ 208,20	€ 295,20	€ 359,30
Fahrverbot für Fuhrwerke § 52/7c 	480/2	K527C03	K527C02	K527C01	K527C03F	K527C02F	K527C01F	K527C03U	K527C02U	K527C01U
		€ 42,40	€ 61,90	€ 77,30	€ 58,30	€ 74,00	€ 92,70	€ 67,10	€ 83,70	€ 102,50
	670/2	K527C06	K527C05	K527C04	K527C06F	K527C05F	K527C04F	K527C06U	K527C05U	K527C04U
		€ 81,10	€ 115,20	€ 140,90	€ 116,90	€ 128,50	€ 164,00	€ 108,30	€ 144,70	€ 172,50
	960/2,5	K527C09	K527C08	K527C07	K527C09F	K527C08F	K527C07F	K527C09U	K527C08U	K527C07U
		€ 171,70	€ 263,80	€ 312,00	€ 229,30	€ 291,70	€ 329,20	€ 208,20	€ 295,20	€ 359,30
Fahrverbot für Kraftfahrzeuge mit gefährlichen Gütern § 52/7e 	480/2	K527E03	K527E02	K527E01	K527E03F	K527E02F	K527E01F	K527E03U	K527E02U	K527E01U
		€ 42,40	€ 61,90	€ 77,30	€ 58,30	€ 74,00	€ 92,70	€ 67,10	€ 83,70	€ 102,50
	670/2	K527E06	K527E05	K527E04	K527E06F	K527E05F	K527E04F	K527E06U	K527E05U	K527E04U
		€ 81,10	€ 115,20	€ 140,90	€ 116,90	€ 128,50	€ 164,00	€ 108,30	€ 144,70	€ 172,50
	960/2,5	K527E09	K527E08	K527E07	K527E09F	K527E08F	K527E07F	K527E09U	K527E08U	K527E07U
		€ 171,70	€ 263,80	€ 312,00	€ 229,30	€ 291,70	€ 329,20	€ 208,20	€ 295,20	€ 359,30
Fahrverbot für Omnibusse § 52/7f 	480/2	K527F03	K527F02	K527F01	K527F03F	K527F02F	K527F01F	K527F03U	K527F02U	K527F01U
		€ 42,40	€ 61,90	€ 77,30	€ 58,30	€ 74,00	€ 92,70	€ 67,10	€ 83,70	€ 102,50
	670/2	K527F06	K527F05	K527F04	K527F06F	K527F05F	K527F04F	K527F06U	K527F05U	K527F04U
		€ 81,10	€ 115,20	€ 140,90	€ 116,90	€ 128,50	€ 164,00	€ 108,30	€ 144,70	€ 172,50
	960/2,5	K527F09	K527F08	K527F07	K527F09F	K527F08F	K527F07F	K527F09U	K527F08U	K527F07U
		€ 171,70	€ 263,80	€ 312,00	€ 229,30	€ 291,70	€ 329,20	€ 208,20	€ 295,20	€ 359,30
Fahrverbot für Omnibusse mit Gewichtsangabe § 52/7f 	480/2	K527F15	K527F14	K527F13	K527F15F	K527F14F	K527F13F	K527F15U	K527F14U	K527F13U
		€ 42,40	€ 61,90	€ 77,30	€ 58,30	€ 74,00	€ 92,70	€ 67,10	€ 83,70	€ 102,50
	670/2	K527F18	K527F17	K527F16	K527F18F	K527F17F	K527F16F	K527F18U	K527F17U	K527F16U
		€ 81,10	€ 115,20	€ 140,90	€ 116,90	€ 128,50	€ 164,00	€ 108,30	€ 144,70	€ 172,50
	960/2,5	K527F21	K527F20	K527F19	K527F21F	K527F20F	K527F19F	K527F21U	K527F20U	K527F19U
		€ 171,70	€ 263,80	€ 312,00	€ 229,30	€ 291,70	€ 329,20	€ 208,20	€ 295,20	€ 359,30
Fahrverbot für Omnibusse mit Längenangabe § 52/7f 	480/2	K527F27	K527F26	K527F25	K527F27F	K527F26F	K527F25F	K527F27U	K527F26U	K527F25U
		€ 42,40	€ 61,90	€ 77,30	€ 58,30	€ 74,00	€ 92,70	€ 67,10	€ 83,70	€ 102,50
	670/2	K527F30	K527F29	K527F28	K527F30F	K527F29F	K527F28F	K527F30U	K527F29U	K527F28U
		€ 81,10	€ 115,20	€ 140,90	€ 116,90	€ 128,50	€ 164,00	€ 108,30	€ 144,70	€ 172,50
	960/2,5	K527F33	K527F32	K527F31	K527F33F	K527F32F	K527F31F	K527F33U	K527F32U	K527F31U
		€ 171,70	€ 263,80	€ 312,00	€ 229,30	€ 291,70	€ 329,20	€ 208,20	€ 295,20	€ 359,30
Fahrverbot für Fahrräder und Motorfahrräder § 52/8a 	480/2	K528A03	K528A02	K528A01	K528A03F	K528A02F	K528A01F	K528A03U	K528A02U	K528A01U
		€ 42,40	€ 61,90	€ 77,30	€ 58,30	€ 74,00	€ 92,70	€ 67,10	€ 83,70	€ 102,50
	670/2	K528A06	K528A05	K528A04	K528A06F	K528A05F	K528A04F	K528A06U	K528A05U	K528A04U
		€ 81,10	€ 115,20	€ 140,90	€ 116,90	€ 128,50	€ 164,00	€ 108,30	€ 144,70	€ 172,50
	960/2,5	K528A09	K528A08	K528A07	K528A09F	K528A08F	K528A07F	K528A09U	K528A08U	K528A07U
		€ 171,70	€ 263,80	€ 312,00	€ 229,30	€ 291,70	€ 329,20	€ 208,20	€ 295,20	€ 359,30







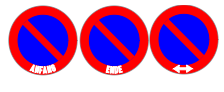

VERKEHRSZEICHEN







VORSCHRIFTSZEICHEN § 52	MASSE/ STÄRKE MM	AUSFÜHRUNG FLACH			AUSFÜHRUNG FORMLINE			AUSFÜHRUNG ALFORM		
		Folie EGP Type 1	Folie HIP Type 2	Folie DGV Type 3	Folie EGP Type 1	Folie HIP Type 2	Folie DGV Type 3	Folie EGP Type 1	Folie HIP Type 2	Folie DGV Type 3
Fahrverbot für Motorfahräder § 52/8b 	480/2	K528B03 € 42,40	K528B02 € 61,90	K528B01 € 77,30	K528B03F € 58,30	K528B02F € 74,00	K528B01F € 92,70	K528B03U € 67,10	K528B02U € 83,70	K528B01U € 102,50
	670/2	K528B06 € 81,10	K528B05 € 115,20	K528B04 € 140,90	K528B06F € 116,90	K528B05F € 128,50	K528B04F € 164,00	K528B06U € 108,30	K528B05U € 144,70	K528B04U € 172,50
	960/2,5	K528B09 € 171,70	K528B08 € 263,80	K528B07 € 312,00	K528B09F € 229,30	K528B08F € 291,70	K528B07F € 329,20	K528B09U € 208,20	K528B08U € 295,20	K528B07U € 359,30
Fahrverbot für Fahrräder § 52/8c 	480/2	K528C03 € 42,40	K528C02 € 61,90	K528C01 € 77,30	K528C03F € 58,30	K528C02F € 74,00	K528C01F € 92,70	K528C03U € 67,10	K528C02U € 83,70	K528C01U € 102,50
	670/2	K528C06 € 81,10	K528C05 € 115,20	K528C04 € 140,90	K528C06F € 116,90	K528C05F € 128,50	K528C04F € 164,00	K528C06U € 108,30	K528C05U € 144,70	K528C04U € 172,50
	960/2,5	K528C09 € 171,70	K528C08 € 263,80	K528C07 € 312,00	K528C09F € 229,30	K528C08F € 291,70	K528C07F € 329,20	K528C09U € 208,20	K528C08U € 295,20	K528C07U € 359,30
Fahrverbot für überm breite Fahrzeuge § 52/9a 	480/2	K529A03 € 42,40	K529A02 € 61,90	K529A01 € 77,30	K529A03F € 58,30	K529A02F € 74,00	K529A01F € 92,70	K529A03U € 67,10	K529A02U € 83,70	K529A01U € 102,50
	670/2	K529A06 € 81,10	K529A05 € 115,20	K529A04 € 140,90	K529A06F € 116,90	K529A05F € 128,50	K529A04F € 164,00	K529A06U € 108,30	K529A05U € 144,70	K529A04U € 172,50
	960/2,5	K529A09 € 171,70	K529A08 € 263,80	K529A07 € 312,00	K529A09F € 229,30	K529A08F € 291,70	K529A07F € 329,20	K529A09U € 208,20	K529A08U € 295,20	K529A07U € 359,30
Fahrverbot für überm hohe Fahrzeuge § 52/9b 	480/2	K529B03 € 42,40	K529B02 € 61,90	K529B01 € 77,30	K529B03F € 58,30	K529B02F € 74,00	K529B01F € 92,70	K529B03U € 67,10	K529B02U € 83,70	K529B01U € 102,50
	670/2	K529B06 € 81,10	K529B05 € 115,20	K529B04 € 140,90	K529B06F € 116,90	K529B05F € 128,50	K529B04F € 164,00	K529B06U € 108,30	K529B05U € 144,70	K529B04U € 172,50
	960/2,5	K529B09 € 171,70	K529B08 € 263,80	K529B07 € 312,00	K529B09F € 229,30	K529B08F € 291,70	K529B07F € 329,20	K529B09U € 208,20	K529B08U € 295,20	K529B07U € 359,30
Fahrverbot für Fahrzeuge mit über.....t Gesamtgewicht § 52/9c 	480/2	K529C03 € 42,40	K529C02 € 61,90	K529C01 € 77,30	K529C03F € 58,30	K529C02F € 74,00	K529C01F € 92,70	K529C03U € 67,10	K529C02U € 83,70	K529C01U € 102,50
	670/2	K529C06 € 81,10	K529C05 € 115,20	K529C04 € 140,90	K529C06F € 116,90	K529C05F € 128,50	K529C04F € 164,00	K529C06U € 108,30	K529C05U € 144,70	K529C04U € 172,50
	960/2,5	K529C09 € 171,70	K529C08 € 263,80	K529C07 € 312,00	K529C09F € 229,30	K529C08F € 291,70	K529C07F € 329,20	K529C09U € 208,20	K529C08U € 295,20	K529C07U € 359,30
Fahrverbot für Fahrzeuge mit über.....t Achsdruck § 52/9d 	480/2	K529D03 € 42,40	K529D02 € 61,90	K529D01 € 77,30	K529D03F € 58,30	K529D02F € 74,00	K529D01F € 92,70	K529D03U € 67,10	K529D02U € 83,70	K529D01U € 102,50
	670/2	K529D06 € 81,10	K529D05 € 115,20	K529D04 € 140,90	K529D06F € 116,90	K529D05F € 128,50	K529D04F € 164,00	K529D06U € 108,30	K529D05U € 144,70	K529D04U € 172,50
	960/2,5	K529D09 € 171,70	K529D08 € 263,80	K529D07 € 312,00	K529D09F € 229,30	K529D08F € 291,70	K529D07F € 329,20	K529D09U € 208,20	K529D08U € 295,20	K529D07U € 359,30
Geschwindigkeitsbeschränkung (erlaubte Höchstgeschwindigkeit) § 52/10a 	480/2	K5210A03 € 42,40	K5210A02 € 61,90	K5210A01 € 77,30	K5210A03F € 58,30	K5210A02F € 74,00	K5210A01F € 92,70	K5210A03U € 67,10	K5210A02U € 83,70	K5210A01U € 102,50
	670/2	K5210A06 € 81,10	K5210A05 € 115,20	K5210A04 € 140,90	K5210A06F € 116,90	K5210A05F € 128,50	K5210A04F € 164,00	K5210A06U € 108,30	K5210A05U € 144,70	K5210A04U € 172,50
	960/2,5	K5210A09 € 171,70	K5210A08 € 263,80	K5210A07 € 312,00	K5210A09F € 229,30	K5210A08F € 291,70	K5210A07F € 329,20	K5210A09U € 208,20	K5210A08U € 295,20	K5210A07U € 359,30
	1200/3	K5210A12 € 401,40	K5210A11 € 554,90	K5210A10 € 593,30					K5210A12U € 529,20	K5210A11U € 625,30

VORSCHRIFTSZEICHEN § 52	MASSE/ STÄRKE MM	AUSFÜHRUNG FLACH			AUSFÜHRUNG FORMLINE			AUSFÜHRUNG ALFORM		
		Folie EGP	Folie HIP	Folie DGV	Folie EGP	Folie HIP	Folie DGV	Folie EGP	Folie HIP	Folie DGV
		Type 1	Type 2	Type 3	Type 1	Type 2	Type 3	Type 1	Type 2	Type 3
Ende der Geschwindigkeitsbeschränkung § 52/10b 	480/2	K5210B03 € 42,40	K5210B02 € 61,90	K5210B01 € 77,30	K5210B03F € 58,30	K5210B02F € 74,00	K5210B01F € 92,70	K5210B03U € 67,10	K5210B02U € 83,70	K5210B01U € 102,50
	670/2	K5210B06 € 81,10	K5210B05 € 115,20	K5210B04 € 140,90	K5210B06F € 116,90	K5210B05F € 128,50	K5210B04F € 164,00	K5210B06U € 108,30	K5210B05U € 144,70	K5210B04U € 172,50
	960/2,5	K5210B09 € 171,70	K5210B08 € 263,80	K5210B07 € 312,00	K5210B09F € 229,30	K5210B08F € 291,70	K5210B07F € 329,20	K5210B09U € 208,20	K5210B08U € 295,20	K5210B07U € 359,30
Ende von Überholverboten und Geschwindigkeitsbeschränkungen § 52/11 	480/2	K521103 € 42,40	K521102 € 61,90	K521101 € 77,30	K521103F € 58,30	K521102F € 74,00	K521101F € 92,70	K521103U € 67,10	K521102U € 83,70	K521101U € 102,50
	670/2	K521106 € 81,10	K521105 € 115,20	K521104 € 140,90	K521106F € 116,90	K521105F € 128,50	K521104F € 164,00	K521106U € 108,30	K521105U € 144,70	K521104U € 172,50
	960/2,5	K521109 € 171,70	K521108 € 263,80	K521107 € 312,00	K521109F € 229,30	K521108F € 291,70	K521107F € 329,20	K521109U € 208,20	K521108U € 295,20	K521107U € 359,30
Beginn einer Zonenbeschränkung § 52/11a 	470x630/2	K5211A03 € 85,80	K5211A02 € 102,10	K5211A01 € 114,50	K5211A03F € 109,60	K5211A02F € 119,30	K5211A01F € 145,00	K5211A03U € 107,90	K5211A02U € 128,90	K5211A01U € 143,10
	630x960/2,5	K5211A06 € 162,80	K5211A05 € 205,30	K5211A04 € 236,30	K5211A06F € 192,90	K5211A05F € 263,50	K5211A04F € 280,80	K5211A06U € 194,40	K5211A05U € 243,30	K5211A04U € 270,70
Ende einer Zonenbeschränkung § 52/11b 	470x630/2	K5211B03 € 85,80	K5211B02 € 102,10	K5211B01 € 114,50	K5211B03F € 109,60	K5211B02F € 119,30	K5211B01F € 145,00	K5211B03U € 107,90	K5211B02U € 128,90	K5211B01U € 143,10
	630x960/2,5	K5211B06 € 162,80	K5211B05 € 205,30	K5211B04 € 236,30	K5211B06F € 192,90	K5211B05F € 263,50	K5211B04F € 280,80	K5211B06U € 194,40	K5211B05U € 243,30	K5211B04U € 270,70
Halt Zoll / Halt Maut § 52/12  	480/2	K521203 € 42,40	K521202 € 61,90	K521201 € 77,30	K521203F € 58,30	K521202F € 74,00	K521201F € 92,70	K521203U € 67,10	K521202U € 83,70	K521201U € 102,50
	670/2	K521206 € 81,10	K521205 € 115,20	K521204 € 140,90	K521206F € 116,90	K521205F € 128,50	K521204F € 164,00	K521206U € 108,30	K521205U € 144,70	K521204U € 172,50
	960/2,5	K521209 € 171,70	K521208 € 263,80	K521207 € 312,00	K521209F € 229,30	K521208F € 291,70	K521207F € 329,20	K521209U € 208,20	K521208U € 295,20	K521207U € 359,30
Parken verboten § 52/13a 	480/2	K5213A03 € 42,40	K5213A02 € 61,90	K5213A01 € 77,30	K5213A03F € 58,30	K5213A02F € 74,00	K5213A01F € 92,70	K5213A03U € 67,10	K5213A02U € 83,70	K5213A01U € 102,50
	670/2	K5213A06 € 81,10	K5213A05 € 115,20	K5213A04 € 140,90	K5213A06F € 116,90	K5213A05F € 128,50	K5213A04F € 164,00	K5213A06U € 108,30	K5213A05U € 144,70	K5213A04U € 172,50
	960/2,5	K5213A09 € 171,70	K5213A08 € 263,80	K5213A07 € 312,00	K5213A09F € 229,30	K5213A08F € 291,70	K5213A07F € 329,20	K5213A09U € 208,20	K5213A08U € 295,20	K5213A07U € 359,30
Parken verboten mit Aufdruck / Sondertafel § 52/13a 	480/2	K5213A15 € 42,40	K5213A14 € 61,90	K5213A13 € 77,30	K5213A15F € 58,30	K5213A14F € 74,00	K5213A13F € 92,70	K5213A15U € 67,10	K5213A14U € 83,70	K5213A13U € 102,50
	Anfang									
	480/2	K5213A18 € 42,40	K5213A17 € 61,90	K5213A16 € 77,30	K5213A18F € 58,30	K5213A17F € 74,00	K5213A16F € 92,70	K5213A18U € 67,10	K5213A17U € 83,70	K5213A16U € 102,50
	Ende									
480/2	K5213A21 € 42,40	K5213A20 € 61,90	K5213A19 € 77,30	K5213A21F € 58,30	K5213A20F € 74,00	K5213A19F € 92,70	K5213A21U € 67,10	K5213A20U € 83,70	K5213A19U € 102,50	











VERKEHRSZEICHEN







VORSCHRIFTSZEICHEN § 52	MASSE/ STÄRKE MM	AUSFÜHRUNG FLACH			AUSFÜHRUNG FORMLINE			AUSFÜHRUNG ALFORM		
		Folie EGP	Folie HIP	Folie DGV	Folie EGP	Folie HIP	Folie DGV	Folie EGP	Folie HIP	Folie DGV
		Type 1	Type 2	Type 3	Type 1	Type 2	Type 3	Type 1	Type 2	Type 3
Halten und Parken verboten § 52/13b 	480/2	K5213B03 € 42,40	K5213B02 € 61,90	K5213B01 € 77,30	K5213B03F € 58,30	K5213B02F € 74,00	K5213B01F € 92,70	K5213B03U € 67,10	K5213B02U € 83,70	K5213B01U € 102,50
	670/2	K5213B06 € 81,10	K5213B05 € 115,20	K5213B04 € 140,90	K5213B06F € 116,90	K5213B05F € 128,50	K5213B04F € 164,00	K5213B06U € 108,30	K5213B05U € 144,70	K5213B04U € 172,50
	960/2,5	K5213B09 € 171,70	K5213B08 € 263,80	K5213B07 € 312,00	K5213B09F € 229,30	K5213B08F € 291,70	K5213B07F € 329,20	K5213B09U € 208,20	K5213B08U € 295,20	K5213B07U € 359,30
Halten und Parken verboten mit Aufdruck / Sondertafel § 52/13b 	480/2 Anfang	K5213B15 € 42,40	K5213B14 € 61,90	K5213B13 € 77,30	K5213B15F € 58,30	K5213B14F € 74,00	K5213B13F € 92,70	K5213B15U € 67,10	K5213B14U € 83,70	K5213B13U € 102,50
	480/2 Ende	K5213B18 € 42,40	K5213B17 € 61,90	K5213B16 € 77,30	K5213B18F € 58,30	K5213B17F € 74,00	K5213B16F € 92,70	K5213B18U € 67,10	K5213B17U € 83,70	K5213B16U € 102,50
	480/2	K5213B21 € 42,40	K5213B20 € 61,90	K5213B19 € 77,30	K5213B21F € 58,30	K5213B20F € 74,00	K5213B19F € 92,70	K5213B21U € 67,10	K5213B20U € 83,70	K5213B19U € 102,50
Parken an ungeraden Tagen verboten § 52/13c 	480/2	K5213C03 € 42,40	K5213C02 € 61,90	K5213C01 € 77,30	K5213C03F € 58,30	K5213C02F € 74,00	K5213C01F € 92,70	K5213C03U € 67,10	K5213C02U € 83,70	K5213C01U € 102,50
	670/2	K5213C06 € 81,10	K5213C05 € 115,20	K5213C04 € 140,90	K5213C06F € 116,90	K5213C05F € 128,50	K5213C04F € 164,00	K5213C06U € 108,30	K5213C05U € 144,70	K5213C04U € 172,50
	960/2,5	K5213C09 € 171,70	K5213C08 € 263,80	K5213C07 € 312,00	K5213C09F € 229,30	K5213C08F € 291,70	K5213C07F € 329,20	K5213C09U € 208,20	K5213C08U € 295,20	K5213C07U € 359,30
Parken an geraden Tagen verboten § 52/13c 	480/2	K5213C15 € 42,40	K5213C14 € 61,90	K5213C13 € 77,30	K5213C15F € 58,30	K5213C14F € 74,00	K5213C13F € 92,70	K5213C15U € 67,10	K5213C14U € 83,70	K5213C13U € 102,50
	670/2	K5213C18 € 81,10	K5213C17 € 115,20	K5213C16 € 140,90	K5213C18F € 116,90	K5213C17F € 128,50	K5213C16F € 164,00	K5213C18U € 108,30	K5213C17U € 144,70	K5213C16U € 172,50
	960/2,5	K5213C21 € 171,70	K5213C20 € 263,80	K5213C19 € 312,00	K5213C21F € 229,30	K5213C20F € 291,70	K5213C19F € 329,20	K5213C21U € 208,20	K5213C20U € 295,20	K5213C19U € 359,30
Kurzparkzone § 52/13d 	470x630/2	K5213D03 € 85,80	K5213D02 € 102,10	K5213D01 € 114,50	K5213D03F € 109,60	K5213D02F € 119,30	K5213D01F € 145,00	K5213D03U € 107,90	K5213D02U € 128,90	K5213D01U € 143,10
	630x960/2,5	K5213D06 € 162,80	K5213D05 € 205,30	K5213D04 € 236,30	K5213D06F € 192,90	K5213D05F € 263,50	K5213D04F € 280,80	K5213D06U € 194,40	K5213D05U € 243,30	K5213D04U € 270,70
	960x1200/3	K5213D09 € 260,80	K5213D08 € 342,40	K5213D07 € 432,50				K5213D09U € 323,80	K5213D08U € 425,10	K5213D07U € 501,00
 Kurzparkzonen mit individuellem Text - Aufpreis € 10,00 pro Zeile										
Ende der Kurzparkzone § 52/13e 	470x470/2	K5213E03 € 50,10	K5213E02 € 70,20	K5213E01 € 86,70	K5213E03F € 93,20	K5213E02F € 100,60	K5213E01F € 105,80	K5213E03U € 86,20	K5213E02U € 106,00	K5213E01U € 125,50
	630x630/2	K5213E06 € 84,30	K5213E05 € 118,80	K5213E04 € 141,90	K5213E06F € 173,50	K5213E05F € 185,30	K5213E04F € 194,40	K5213E06U € 120,60	K5213E05U € 156,80	K5213E04U € 191,10
	960x960/2,5	K5213E09 € 203,30	K5213E08 € 293,30	K5213E07 € 365,20				K5213E09U € 252,50	K5213E08U € 353,20	K5213E07U € 415,50

VORSCHRIFTszeICHEN § 52	MASSE/ STÄRKE MM	AUSFÜHRUNG FLACH			AUSFÜHRUNG FORMLINE			AUSFÜHRUNG ALFORM		
		Folie EGP Type 1	Folie HIP Type 2	Folie DGV Type 3	Folie EGP Type 1	Folie HIP Type 2	Folie DGV Type 3	Folie EGP Type 1	Folie HIP Type 2	Folie DGV Type 3
Huperverbot § 52/14 	480/2	K521403 € 42,40	K521402 € 61,90	K521401 € 77,30	K521403F € 58,30	K521402F € 74,00	K521401F € 92,70	K521403U € 67,10	K521402U € 83,70	K521401U € 102,50
	670/2	K521406 € 81,10	K521405 € 115,20	K521404 € 140,90	K521406F € 116,90	K521405F € 128,50	K521404F € 164,00	K521406U € 108,30	K521405U € 144,70	K521404U € 172,50
	960/2,5	K521409 € 171,70	K521408 € 263,80	K521407 € 312,00	K521409F € 229,30	K521408F € 291,70	K521407F € 329,20	K521409U € 208,20	K521408U € 295,20	K521407U € 359,30
Reitverbot § 52/14a 	480/2	K5214A03 € 42,40	K5214A02 € 61,90	K5214A01 € 77,30	K5214A03F € 58,30	K5214A02F € 74,00	K5214A01F € 92,70	K5214A03U € 67,10	K5214A02U € 83,70	K5214A01U € 102,50
	670/2	K5214A06 € 81,10	K5214A05 € 115,20	K5214A04 € 140,90	K5214A06F € 116,90	K5214A05F € 128,50	K5214A04F € 164,00	K5214A06U € 108,30	K5214A05U € 144,70	K5214A04U € 172,50
	960/2,5	K5214A09 € 171,70	K5214A08 € 263,80	K5214A07 € 312,00	K5214A09F € 229,30	K5214A08F € 291,70	K5214A07F € 329,20	K5214A09U € 208,20	K5214A08U € 295,20	K5214A07U € 359,30
Verbot für Fußgänger § 52/14b 	480/2	K5214B03 € 42,40	K5214B02 € 61,90	K5214B01 € 77,30	K5214B03F € 58,30	K5214B02F € 74,00	K5214B01F € 92,70	K5214B03U € 67,10	K5214B02U € 83,70	K5214B01U € 102,50
	670/2	K5214B06 € 81,10	K5214B05 € 115,20	K5214B04 € 140,90	K5214B06F € 116,90	K5214B05F € 128,50	K5214B04F € 164,00	K5214B06U € 108,30	K5214B05U € 144,70	K5214B04U € 172,50
	960/2,5	K5214B09 € 171,70	K5214B08 € 263,80	K5214B07 € 312,00	K5214B09F € 229,30	K5214B08F € 291,70	K5214B07F € 329,20	K5214B09U € 208,20	K5214B08U € 295,20	K5214B07U € 359,30
vorgeschriebene Fahrtrichtung § 52/15 Ausf.a 	480/2		K5215A02 € 61,90	K5215A01 € 77,30		K5215A02F € 74,00	K5215A01F € 92,70		K5215A02U € 83,70	K5215A01U € 102,50
	670/2		K5215A05 € 115,20	K5215A04 € 140,90		K5215A05F € 128,50	K5215A04F € 164,00		K5215A05U € 144,70	K5215A04U € 172,50
	960/2,5		K5215A08 € 263,80	K5215A07 € 312,00		K5215A08F € 291,70	K5215A07F € 329,20		K5215A08U € 295,20	K5215A07U € 359,30
vorgeschriebene Fahrtrichtung § 52/15 Ausf.b 	480/2		K5215B02 € 61,90	K5215B01 € 77,30		K5215B02F € 74,00	K5215B01F € 92,70		K5215B02U € 83,70	K5215B01U € 102,50
	670/2		K5215B05 € 115,20	K5215B04 € 140,90		K5215B05F € 128,50	K5215B04F € 164,00		K5215B05U € 144,70	K5215B04U € 172,50
	960/2,5		K5215B08 € 263,80	K5215B07 € 312,00		K5215B08F € 291,70	K5215B07F € 329,20		K5215B08U € 295,20	K5215B07U € 359,30
vorgeschriebene Fahrtrichtung § 52/15 Ausf.c 	480/2		K5215C02 € 61,90	K5215C01 € 77,30		K5215C02F € 74,00	K5215C01F € 92,70		K5215C02U € 83,70	K5215C01U € 102,50
	670/2		K5215C05 € 115,20	K5215C04 € 140,90		K5215C05F € 128,50	K5215C04F € 164,00		K5215C05U € 144,70	K5215C04U € 172,50
	960/2,5		K5215C08 € 263,80	K5215C07 € 312,00		K5215C08F € 291,70	K5215C07F € 329,20		K5215C08U € 295,20	K5215C07U € 359,30
vorgeschriebene Fahrtrichtung § 52/15 Ausf.d / gerade 	480/2		K5215D02 € 61,90	K5215D01 € 77,30		K5215D02F € 74,00	K5215D01F € 92,70		K5215D02U € 83,70	K5215D01U € 102,50
	670/2		K5215D05 € 115,20	K5215D04 € 140,90		K5215D05F € 128,50	K5215D04F € 164,00		K5215D05U € 144,70	K5215D04U € 172,50
	960/2,5		K5215D08 € 263,80	K5215D07 € 312,00		K5215D08F € 291,70	K5215D07F € 329,20		K5215D08U € 295,20	K5215D07U € 359,30
	1200/3		K5215D11 € 554,90	K5215D10 € 593,30					K5215D11U € 625,30	K5215D10U € 663,80







VERKEHRSZEICHEN

VORSCHRIFTSZEICHEN § 52	MASSE/ STÄRKE MM	AUSFÜHRUNG FLACH			AUSFÜHRUNG FORMLINE			AUSFÜHRUNG ALFORM		
		Folie EGP	Folie HIP	Folie DGV	Folie EGP	Folie HIP	Folie DGV	Folie EGP	Folie HIP	Folie DGV
		Type 1	Type 2	Type 3	Type 1	Type 2	Type 3	Type 1	Type 2	Type 3
vorgeschriebene Fahrtrichtung § 52/15 Ausf.d / schräg rechts 	480/2		K5215D02 € 61,90	K5215D01 € 77,30		K5215D02F € 74,00	K5215D01F € 92,70		K5215D02U € 83,70	K5215D01U € 102,50
	670/2		K5215D05 € 115,20	K5215D04 € 140,90		K5215D05F € 128,50	K5215D04F € 164,00		K5215D05U € 144,70	K5215D04U € 172,50
	960/2,5		K5215D08 € 263,80	K5215D07 € 312,00		K5215D08F € 291,70	K5215D07F € 329,20		K5215D08U € 295,20	K5215D07U € 359,30
	1200/3		K5215D11 € 554,90	K5215D10 € 593,30					K5215D11U € 625,30	K5215D10U € 663,80
vorgeschriebene Fahrtrichtung § 52/15 Ausf.e 	480/2		K5215E02 € 61,90	K5215E01 € 77,30		K5215E02F € 74,00	K5215E01F € 92,70		K5215E02U € 83,70	K5215E01U € 102,50
	670/2		K5215E05 € 115,20	K5215E04 € 140,90		K5215E05F € 128,50	K5215E04F € 164,00		K5215E05U € 144,70	K5215E04U € 172,50
	960/2,5		K5215E08 € 263,80	K5215E07 € 312,00		K5215E08F € 291,70	K5215E07F € 329,20		K5215E08U € 295,20	K5215E07U € 359,30
vorgeschriebene Fahrtrichtung § 52/15 Ausf.f 	480/2		K5215F02 € 61,90	K5215F01 € 77,30		K5215F02F € 74,00	K5215F01F € 92,70		K5215F02U € 83,70	K5215F01U € 102,50
	670/2		K5215F05 € 115,20	K5215F04 € 140,90		K5215F05F € 128,50	K5215F04F € 164,00		K5215F05U € 144,70	K5215F04U € 172,50
	960/2,5		K5215F08 € 263,80	K5215F07 € 312,00		K5215F08F € 291,70	K5215F07F € 329,20		K5215F08U € 295,20	K5215F07U € 359,30
vorgeschriebene Fahrtrichtung für Kraftfahrzeuge mit gefährlichen Gütern § 52/15a a  b  c 	470x630/2	K5215AG03 € 85,80	K5215AG02 € 102,10	K5215AG01 € 114,50	K5215AG03F € 109,60	K5215AG02F € 119,30	K5215AG01F € 145,00	K5215AG03U € 107,90	K5215AG02U € 128,90	K5215AG01U € 143,10
	630x960/2,5	K5215AG06 € 162,80	K5215AG05 € 205,30	K5215AG04 € 236,30	K5215AG06F € 192,90	K5215AG05F € 263,50	K5215AG04F € 280,80	K5215AG06U € 194,40	K5215AG05U € 243,30	K5215AG04U € 270,70
	960x1200/3	K5215AG09 € 260,80	K5215AG08 € 342,40	K5215AG07 € 432,50				K5215AG09U € 323,80	K5215AG08U € 425,10	K5215AG07U € 501,00
Radweg § 52/16 	480/2	K521603 € 42,40	K521602 € 61,90	K521601 € 77,30	K521603F € 58,30	K521602F € 74,00	K521601F € 92,70	K521603U € 67,10	K521602U € 83,70	K521601U € 102,50
	670/2	K521606 € 81,10	K521605 € 115,20	K521604 € 140,90	K521606F € 116,90	K521605F € 128,50	K521604F € 164,00	K521606U € 108,30	K521605U € 144,70	K521604U € 172,50
	960/2,5	K521609 € 171,70	K521608 € 263,80	K521607 € 312,00	K521609F € 229,30	K521608F € 291,70	K521607F € 329,20	K521609U € 208,20	K521608U € 295,20	K521607U € 359,30
Ende eines Radwegs § 52/16a 	480/2	K5216A03 € 42,40	K5216A02 € 61,90	K5216A01 € 77,30	K5216A03F € 58,30	K5216A02F € 74,00	K5216A01F € 92,70	K5216A03U € 67,10	K5216A02U € 83,70	K5216A01U € 102,50
	670/2	K5216A06 € 81,10	K5216A05 € 115,20	K5216A04 € 140,90	K5216A06F € 116,90	K5216A05F € 128,50	K5216A04F € 164,00	K5216A06U € 108,30	K5216A05U € 144,70	K5216A04U € 172,50
	960/2,5	K5216A09 € 171,70	K5216A08 € 263,80	K5216A07 € 312,00	K5216A09F € 229,30	K5216A08F € 291,70	K5216A07F € 329,20	K5216A09U € 208,20	K5216A08U € 295,20	K5216A07U € 359,30
Gehweg § 52/17 	480/2	K521703 € 42,40	K521702 € 61,90	K521701 € 77,30	K521703F € 58,30	K521702F € 74,00	K521701F € 92,70	K521703U € 67,10	K521702U € 83,70	K521701U € 102,50
	670/2	K521706 € 81,10	K521705 € 115,20	K521704 € 140,90	K521706F € 116,90	K521705F € 128,50	K521704F € 164,00	K521706U € 108,30	K521705U € 144,70	K521704U € 172,50
	960/2,5	K521709 € 171,70	K521708 € 263,80	K521707 € 312,00	K521709F € 229,30	K521708F € 291,70	K521707F € 329,20	K521709U € 208,20	K521708U € 295,20	K521707U € 359,30

VORSCHRIFTSZEICHEN § 52	MASSE/ STÄRKE MM	AUSFÜHRUNG FLACH			AUSFÜHRUNG FORMLINE			AUSFÜHRUNG ALFORM			
		Folie EGP	Folie HIP	Folie DGV	Folie EGP	Folie HIP	Folie DGV	Folie EGP	Folie HIP	Folie DGV	
		Type 1	Type 2	Type 3	Type 1	Type 2	Type 3	Type 1	Type 2	Type 3	
Ende eines Gehwegs § 52/17c 	480/2	K5217C03	K5217C02	K5217C01	K5217C03F	K5217C02F	K5217C01F	K5217C03U	K5217C02U	K5217C01U	
		€ 42,40	€ 61,90	€ 77,30	€ 58,30	€ 74,00	€ 92,70	€ 67,10	€ 83,70	€ 102,50	
		670/2	K5217C06	K5217C05	K5217C04	K5217C06F	K5217C05F	K5217C04F	K5217C06U	K5217C05U	K5217C04U
	€ 81,10	€ 115,20	€ 140,90	€ 116,90	€ 128,50	€ 164,00	€ 108,30	€ 144,70	€ 172,50		
	960/2,5	K5217C09	K5217C08	K5217C07	K5217C09F	K5217C08F	K5217C07F	K5217C09U	K5217C08U	K5217C07U	
		€ 171,70	€ 263,80	€ 312,00	€ 229,30	€ 291,70	€ 329,20	€ 208,20	€ 295,20	€ 359,30	
	Geh- und Radweg (gemeinsam) § 52/17a lit.c) 	480/2	K5217A15	K5217A14	K5217A13	K5217A15F	K5217A14F	K5217A13F	K5217A15U	K5217A14U	K5217A13U
			€ 42,40	€ 61,90	€ 77,30	€ 58,30	€ 74,00	€ 92,70	€ 67,10	€ 83,70	€ 102,50
670/2			K5217A18	K5217A17	K5217A16	K5217A18F	K5217A17F	K5217A16F	K5217A18U	K5217A17U	K5217A16U
€ 81,10		€ 115,20	€ 140,90	€ 116,90	€ 128,50	€ 164,00	€ 108,30	€ 144,70	€ 172,50		
960/2,5		K5217A21	K5217A20	K5217A19	K5217A21F	K5217A20F	K5217A19F	K5217A21U	K5217A20U	K5217A19U	
		€ 171,70	€ 263,80	€ 312,00	€ 229,30	€ 291,70	€ 329,20	€ 208,20	€ 295,20	€ 359,30	
Ende eines Geh- und Radwegs (gemeinsam) § 52/17a lit.c) 		480/2	K5217A27	K5217A26	K5217A25	K5217A27F	K5217A26F	K5217A25F	K5217A27U	K5217A26U	K5217A25U
			€ 42,40	€ 61,90	€ 77,30	€ 58,30	€ 74,00	€ 92,70	€ 67,10	€ 83,70	€ 102,50
	670/2		K5217A30	K5217A29	K5217A28	K5217A30F	K5217A29F	K5217A28F	K5217A30U	K5217A29U	K5217A28U
	€ 81,10	€ 115,20	€ 140,90	€ 116,90	€ 128,50	€ 164,00	€ 108,30	€ 144,70	€ 172,50		
	960/2,5	K5217A33	K5217A32	K5217A31	K5217A33F	K5217A32F	K5217A31F	K5217A33U	K5217A32U	K5217A31U	
		€ 171,70	€ 263,80	€ 312,00	€ 229,30	€ 291,70	€ 329,20	€ 208,20	€ 295,20	€ 359,30	
	Geh- und Radweg (getrennt) § 52/17a lit.b) Bitte Anordnung bekanntgeben! 	480/2	K5217A39	K5217A38	K5217A37	K5217A39F	K5217A38F	K5217A37F	K5217A39U	K5217A38U	K5217A37U
			€ 42,40	€ 61,90	€ 77,30	€ 58,30	€ 74,00	€ 92,70	€ 67,10	€ 83,70	€ 102,50
670/2			K5217A42	K5217A41	K5217A40	K5217A42F	K5217A41F	K5217A40F	K5217A42U	K5217A41U	K5217A40U
€ 81,10		€ 115,20	€ 140,90	€ 116,90	€ 128,50	€ 164,00	€ 108,30	€ 144,70	€ 172,50		
960/2,5		K5217A45	K5217A44	K5217A43	K5217A45F	K5217A44F	K5217A43F	K5217A45U	K5217A44U	K5217A43U	
		€ 171,70	€ 263,80	€ 312,00	€ 229,30	€ 291,70	€ 329,20	€ 208,20	€ 295,20	€ 359,30	
Ende eines Geh- und Radwegs (getrennt) § 52/17a lit.d) Bitte Anordnung bekanntgeben! 		480/2	K5217A51	K5217A50	K5217A49	K5217A51F	K5217A50F	K5217A49F	K5217A51U	K5217A50U	K5217A49U
			€ 42,40	€ 61,90	€ 77,30	€ 58,30	€ 74,00	€ 92,70	€ 67,10	€ 83,70	€ 102,50
	670/2		K5217A54	K5217A53	K5217A52	K5217A54F	K5217A53F	K5217A52F	K5217A54U	K5217A53U	K5217A52U
	€ 81,10	€ 115,20	€ 140,90	€ 116,90	€ 128,50	€ 164,00	€ 108,30	€ 144,70	€ 172,50		
	960/2,5	K5217A57	K5217A56	K5217A55	K5217A57F	K5217A56F	K5217A55F	K5217A57U	K5217A56U	K5217A55U	
		€ 171,70	€ 263,80	€ 312,00	€ 229,30	€ 291,70	€ 329,20	€ 208,20	€ 295,20	€ 359,30	
	Reitweg § 52/17b 	480/2	K5217B03	K5217B02	K5217B01	K5217B03F	K5217B02F	K5217B01F	K5217B03U	K5217B02U	K5217B01U
			€ 42,40	€ 61,90	€ 77,30	€ 58,30	€ 74,00	€ 92,70	€ 67,10	€ 83,70	€ 102,50
670/2			K5217B06	K5217B05	K5217B04	K5217B06F	K5217B05F	K5217B04F	K5217B06U	K5217B05U	K5217B04U
€ 81,10		€ 115,20	€ 140,90	€ 116,90	€ 128,50	€ 164,00	€ 108,30	€ 144,70	€ 172,50		
960/2,5		K5217B09	K5217B08	K5217B07	K5217B09F	K5217B08F	K5217B07F	K5217B09U	K5217B08U	K5217B07U	
		€ 171,70	€ 263,80	€ 312,00	€ 229,30	€ 291,70	€ 329,20	€ 208,20	€ 295,20	€ 359,30	
Unterführung § 52/18 		480/2	K521803	K521802	K521801	K521803F	K521802F	K521801F	K521803U	K521802U	K521801U
			€ 42,40	€ 61,90	€ 77,30	€ 58,30	€ 74,00	€ 92,70	€ 67,10	€ 83,70	€ 102,50
	670/2		K521806	K521805	K521804	K521806F	K521805F	K521804F	K521806U	K521805U	K521804U
	€ 81,10	€ 115,20	€ 140,90	€ 116,90	€ 128,50	€ 164,00	€ 108,30	€ 144,70	€ 172,50		
	960/2,5	K521809	K521808	K521807	K521809F	K521808F	K521807F	K521809U	K521808U	K521807U	
		€ 171,70	€ 263,80	€ 312,00	€ 229,30	€ 291,70	€ 329,20	€ 208,20	€ 295,20	€ 359,30	



VERKEHRSZEICHEN

VORSCHRIFTSZEICHEN § 52	MASSE/ STÄRKE MM	AUSFÜHRUNG FLACH			AUSFÜHRUNG FORMLINE			AUSFÜHRUNG ALFORM		
		Folie EGP Type 1	Folie HIP Type 2	Folie DGV Type 3	Folie EGP Type 1	Folie HIP Type 2	Folie DGV Type 3	Folie EGP Type 1	Folie HIP Type 2	Folie DGV Type 3
		K521903	K521902	K521901	K521903F	K521902F	K521901F	K521903U	K521902U	K521901U
vorgeschriebene Mindestgeschwindigkeit § 52/19 	480/2	€ 42,40	€ 61,90	€ 77,30	€ 58,30	€ 74,00	€ 92,70	€ 67,10	€ 83,70	€ 102,50
	670/2	€ 81,10	€ 115,20	€ 140,90	€ 116,90	€ 128,50	€ 164,00	€ 108,30	€ 144,70	€ 172,50
	960/2,5	€ 171,70	€ 263,80	€ 312,00	€ 229,30	€ 291,70	€ 329,20	€ 208,20	€ 295,20	€ 359,30
Ende der vorgeschriebenen Mindestgeschwindigkeit § 52/19a 	480/2	€ 42,40	€ 61,90	€ 77,30	€ 58,30	€ 74,00	€ 92,70	€ 67,10	€ 83,70	€ 102,50
	670/2	€ 81,10	€ 115,20	€ 140,90	€ 116,90	€ 128,50	€ 164,00	€ 108,30	€ 144,70	€ 172,50
	960/2,5	€ 171,70	€ 263,80	€ 312,00	€ 229,30	€ 291,70	€ 329,20	€ 208,20	€ 295,20	€ 359,30
Umkehrgebot § 52/21 	480/2	€ 42,40	€ 61,90	€ 77,30	€ 58,30	€ 74,00	€ 92,70	€ 67,10	€ 83,70	€ 102,50
	670/2	€ 81,10	€ 115,20	€ 140,90	€ 116,90	€ 128,50	€ 164,00	€ 108,30	€ 144,70	€ 172,50
	960/2,5	€ 171,70	€ 263,80	€ 312,00	€ 229,30	€ 291,70	€ 329,20	€ 208,20	€ 295,20	€ 359,30
Schneeketten vorgeschrieben § 52/22 	480/2	€ 42,40	€ 61,90	€ 77,30	€ 58,30	€ 74,00	€ 92,70	€ 67,10	€ 83,70	€ 102,50
	670/2	€ 81,10	€ 115,20	€ 140,90	€ 116,90	€ 128,50	€ 164,00	€ 108,30	€ 144,70	€ 172,50
	960/2,5	€ 171,70	€ 263,80	€ 312,00	€ 229,30	€ 291,70	€ 329,20	€ 208,20	€ 295,20	€ 359,30
Ende der Schneekettenpflicht § 52/22a 	480/2	€ 42,40	€ 61,90	€ 77,30	€ 58,30	€ 74,00	€ 92,70	€ 67,10	€ 83,70	€ 102,50
	670/2	€ 81,10	€ 115,20	€ 140,90	€ 116,90	€ 128,50	€ 164,00	€ 108,30	€ 144,70	€ 172,50
	960/2,5	€ 171,70	€ 263,80	€ 312,00	€ 229,30	€ 291,70	€ 329,20	€ 208,20	€ 295,20	€ 359,30



SCHILDER VON WELT MIT UMWELTEFFEKT.

ITEK

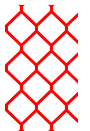

VORSCHRIFTSZEICHEN § 52	MASSE/ STÄRKE MM	AUSFÜHRUNG FLACH			AUSFÜHRUNG FORMLINE			AUSFÜHRUNG ALFORM		
		Folie EGP Type 1	Folie HIP Type 2	Folie DGV Type 3	Folie EGP Type 1	Folie HIP Type 2	Folie DGV Type 3	Folie EGP Type 1	Folie HIP Type 2	Folie DGV Type 3
		Klapptafel								
Schneekettenpflicht Sondertafel 	480/2	S5222A03 € 214,30	S5222A02 € 225,90	S5222A01 € 234,10	S5222A03F € 283,60	S5222A02F € 295,80	S5222A01F € 266,40	S5222A03U € 258,30	S5222A02U € 269,00	S5222A01U € 276,50
	670/2	S5222A06 € 283,40	S5222A05 € 303,60	S5222A04 € 317,90	S5222A06F € 400,90	S5222A05F € 419,50	S5222A04F € 433,80	S5222A06U € 355,90	S5222A05U € 376,10	S5222A04U € 390,40
	960/2,5	S5222A09 € 497,30	S5222A08 € 539,90	S5222A07 € 556,90	S5222A09F € 698,20	S5222A08F € 740,80	S5222A07F € 757,80	S5222A09U € 564,60	S5222A08U € 607,20	S5222A07U € 624,30

Sonderlösungen wie Klapptafeln oder Infotafeln mit Einschub auf Anfrage lieferbar!



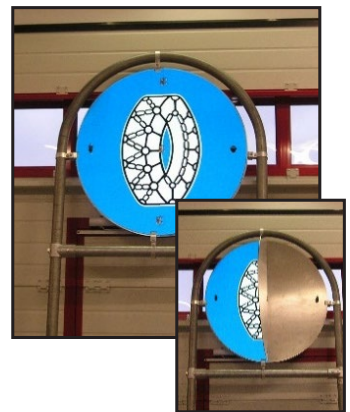



Weitere Anwendungsmöglichkeiten









WIR FÜHREN NUR GUTES IM SCHILDE.



VERKEHRSZEICHEN



HINWEISZEICHEN § 53	MASSE/ STÄRKE MM	AUSFÜHRUNG FLACH			AUSFÜHRUNG FORMLINE			AUSFÜHRUNG ALFORM		
		Folie EGP	Folie HIP	Folie DGV	Folie EGP	Folie HIP	Folie DGV	Folie EGP	Folie HIP	Folie DGV
		Type 1	Type 2	Type 3	Type 1	Type 2	Type 3	Type 1	Type 2	Type 3
Parken § 53/1a 	470x470/2	K531A03 € 50,10	K531A02 € 70,20	K531A01 € 86,70	K531A03F € 93,20	K531A02F € 100,60	K531A01F € 105,80	K531A03U € 86,20	K531A02U € 106,00	K531A01U € 125,50
	630x630/2	K531A06 € 84,30	K531A05 € 118,80	K531A04 € 141,90	K531A06F € 173,50	K531A05F € 185,30	K531A04F € 194,40	K531A06U € 120,60	K531A05U € 156,80	K531A04U € 191,10
	960x960/2,5	K531A09 € 203,30	K531A08 € 293,30	K531A07 € 365,20				K531A09U € 252,50	K531A08U € 353,20	K531A07U € 415,50
Parken mit Symbol § 53/1a 	470x470/2	K531A13 € 50,10	K531A12 € 70,20	K531A11 € 86,70	K531A13F € 93,20	K531A12F € 100,60	K531A11F € 105,80	K531A13U € 86,20	K531A12U € 106,00	K531A11U € 125,50
	630x630/2	K531A16 € 84,30	K531A15 € 118,80	K531A14 € 141,90	K531A16F € 173,50	K531A15F € 185,30	K531A14F € 194,40	K531A16U € 120,60	K531A15U € 156,80	K531A14U € 191,10
	960x960/2,5	K531A19 € 203,30	K531A18 € 293,30	K531A17 € 365,20				K531A19U € 252,50	K531A18U € 353,20	K531A17U € 415,50
Parken mit Meter-Angabe oder Pfeil links oder rechts § 53/1b 	470x630/2	K531B03 € 85,80	K531B02 € 102,10	K531B01 € 114,50	K531B03F € 110,50	K531B02F € 119,30	K531B01F € 141,20	K531B03U € 107,90	K531B02U € 128,90	K531B01U € 143,10
	630x960/2,5	K531B06 € 162,80	K531B05 € 205,30	K531B04 € 236,30	K531B06F € 192,90	K531B05F € 263,50	K531B04F € 280,80	K531B06U € 194,40	K531B05U € 243,30	K531B04U € 270,70
	960x1200/3	K531B09 € 260,80	K531B08 € 342,40	K531B07 € 432,50				K531B09U € 323,80	K531B08U € 425,10	K531B07U € 501,00
	1000x1500/3	K531B073 € 378,90	K531B072 € 519,80	K531B071 € 597,30				K531B073U € 432,30	K531B072U € 565,40	K531B071U € 647,40
Parken mit Symbol oder individuellem Text § 53/1b  <p>Aufpreis pro Zeile: € 10,00 Aufpreis pro Symbol: € 15,00</p>	470x630/2	K531B13 € 85,80	K531B12 € 102,10	K531B11 € 114,50	K531B13F € 110,50	K531B12F € 119,30	K531B11F € 141,20	K531B13U € 107,90	K531B12U € 128,90	K531B11U € 143,10
	630x960/2,5	K531B16 € 162,80	K531B15 € 205,30	K531B14 € 236,30	K531B16F € 192,90	K531B15F € 263,50	K531B14F € 280,80	K531B16U € 194,40	K531B15U € 243,30	K531B14U € 270,70
	960x1200/3	K531B19 € 260,80	K531B18 € 342,40	K531B17 € 432,50				K531B19U € 323,80	K531B18U € 425,10	K531B17U € 501,00
	1000x1500/3	K531B22 € 378,90	K531B21 € 519,80	K531B20 € 597,30				K531B22U € 432,30	K531B21U € 565,40	K531B20U € 647,40
Pannenplatz § 53/1c 	630x960/2,5	K531C03 € 162,80	K531C02 € 205,30	K531C01 € 236,30	K531C03F € 192,90	K531C02F € 263,50	K531C01F € 280,80	K531C03U € 194,40	K531C02U € 243,30	K531C01U € 270,70
	1000x1500/3	K531C06 € 378,90	K531C05 € 519,80	K531C04 € 597,30				K531C06U € 432,30	K531C05U € 565,40	K531C04U € 647,40
Spital § 53/2 	470x630/2	K53203 € 85,80	K53202 € 102,10	K53201 € 114,50	K53203F € 110,50	K53202F € 119,30	K53201F € 141,20	K53203U € 107,90	K53202U € 128,90	K53201U € 143,10
	630x960/2,5	K53206 € 162,80	K53205 € 205,30	K53204 € 236,30	K53206F € 192,90	K53205F € 263,50	K53204F € 280,80	K53206U € 194,40	K53205U € 243,30	K53204U € 270,70
	960x1200/3	K53209 € 260,80	K53208 € 342,40	K53207 € 432,50				K53209U € 323,80	K53208U € 425,10	K53207U € 501,00
Kennzeichnung eines Schutzwegs § 53/2a 	470x470/2		K532A02 € 70,20	K532A01 € 86,70		K532A02F € 100,60	K532A01F € 105,80		K532A02U € 106,00	K532A01U € 125,50
	630x630/2		K532A05 € 118,80	K532A04 € 141,90		K532A05F € 185,30	K532A04F € 194,40		K532A05U € 156,80	K532A04U € 191,10
	960x960/2,5		K532A08 € 293,30	K532A07 € 365,20					K532A08U € 353,20	K532A07U € 415,50







Auf Wunsch gestalten wir auch Parkplatztafeln mit individuellem Digitaldruck! Preis auf Anfrage!

HINWEISZEICHEN § 53	MASSE/ STÄRKE MM	AUSFÜHRUNG FLACH			AUSFÜHRUNG FORMLINE			AUSFÜHRUNG ALFORM		
		Folie EGP	Folie HIP	Folie DGV	Folie EGP	Folie HIP	Folie DGV	Folie EGP	Folie HIP	Folie DGV
		Type 1	Type 2	Type 3	Type 1	Type 2	Type 3	Type 1	Type 2	Type 3
Schutzwegzeichen laut StVO Sondertafel mit Kontrasthintergrund (fluoreszierend) § 53/2a Sonderausf. 	630x630/2			S532A01			S532A01F			S532A01U
	470x470/2			€ 281,80			€ 602,20			€ 456,70
	800x800/2,5 630x630/2			S532A04 € 631,70						S532A04U € 720,50
Kennzeichnung einer Radfahrerüberfahrt § 53/2b 	470x470/2		K532B02 € 70,20	K532B01 € 86,70		K532B02F € 100,60	K532B01F € 105,80		K532B02U € 106,00	K532B01U € 125,50
	630x630/2		K532B05 € 118,80	K532B04 € 141,90		K532B05F € 185,30	K532B04F € 194,40		K532B05U € 156,80	K532B04U € 191,10
	960x960/2,5		K532B08 € 293,30	K532B07 € 365,20					K532B08U € 353,20	K532B07U € 415,50
Schutzwegzeichen laut StVO Sondertafel mit Kontrasthintergrund (fluoreszierend) § 53/2b Sonderausf. 	630x630/2			S532B01			S532B01F			S532B01U
	470x470/2			€ 281,80			€ 602,20			€ 456,70
	800x800/2,5 630x630/2			S532B04 € 631,70						S532B04U € 720,50
Kennzeichnung eines Schutzweges und einer Radfahrerüberfahrt § 53/2c Ausf. a) 	470x470/2		K532C02 € 70,20	K532C01 € 86,70		K532C02F € 100,60	K532C01F € 105,80		K532C02U € 106,00	K532C01U € 125,50
	630x630/2		K532C05 € 118,80	K532C04 € 141,90		K532C05F € 185,30	K532C04F € 194,40		K532C05U € 156,80	K532C04U € 191,10
	960x960/2,5		K532C08 € 293,30	K532C07 € 365,20					K532C08U € 353,20	K532C07U € 415,50
Kennzeichnung einer Radfahrer- überfahrt und eines Schutzweges § 53/2c Ausf. b) 	470x470/2		K532C14 € 70,20	K532C13 € 86,70		K532C14F € 100,60	K532C13F € 105,80		K532C14U € 106,00	K532C13U € 125,50
	630x630/2		K532C17 € 118,80	K532C16 € 141,90		K532C17F € 185,30	K532C16F € 194,40		K532C17U € 156,80	K532C16U € 191,10
	960x960/2,5		K532C20 € 293,30	K532C19 € 365,20					K532C20U € 353,20	K532C19U € 415,50
Kennzeichnung einer Radfahrer- überfahrt und eines Schutzweges § 53/2c Ausf. c) 	470x470/2		K532C26 € 70,20	K532C25 € 86,70		K532C26F € 100,60	K532C25F € 105,80		K532C26U € 106,00	K532C25U € 125,50
	630x630/2		K532C29 € 118,80	K532C28 € 141,90		K532C29F € 185,30	K532C28F € 194,40		K532C29U € 156,80	K532C28U € 191,10
	960x960/2,5		K532C32 € 293,30	K532C31 € 365,20					K532C32U € 353,20	K532C31U € 415,50
Erste Hilfe § 53/3 	470x630/2	K53303 € 85,80	K53302 € 102,10	K53301 € 114,50	K53303F € 110,50	K53302F € 119,30	K53301F € 141,20	K53303U € 107,90	K53302U € 128,90	K53301U € 143,10
	630x960/2,5	K53306 € 162,80	K53305 € 205,30	K53304 € 236,30	K53306F € 192,90	K53305F € 263,50	K53304F € 280,80	K53306U € 194,40	K53305U € 243,30	K53304U € 270,70
	960x1200/3	K53309 € 260,80	K53308 € 342,40	K53307 € 432,50				K53309U € 323,80	K53308U € 425,10	K53307U € 501,00











VERKEHRSZEICHEN





HINWEISZEICHEN § 53	MASSE/ STÄRKE MM	AUSFÜHRUNG FLACH			AUSFÜHRUNG FORMLINE			AUSFÜHRUNG ALFORM		
		Folie EGP	Folie HIP	Folie DGV	Folie EGP	Folie HIP	Folie DGV	Folie EGP	Folie HIP	Folie DGV
		Type 1	Type 2	Type 3	Type 1	Type 2	Type 3	Type 1	Type 2	Type 3
Gottesdienste § 53/3a 	470x630/2	K533A03 € 85,80	K533A02 € 102,10	K533A01 € 114,50	K533A03F € 110,50	K533A02F € 119,30	K533A01F € 141,20	K533A03U € 107,90	K533A02U € 128,90	K533A01U € 143,10
	630x960/2,5	K533A06 € 162,80	K533A05 € 205,30	K533A04 € 236,30	K533A06F € 192,90	K533A05F € 263,50	K533A04F € 280,80	K533A06U € 194,40	K533A05U € 243,30	K533A04U € 270,70
	960x1200/3	K533A09 € 260,80	K533A08 € 342,40	K533A07 € 432,50				K533A09U € 323,80	K533A08U € 425,10	K533A07U € 501,00
Pannenhilfe § 53/4 	470x630/2	K53403 € 85,80	K53402 € 102,10	K53401 € 114,50	K53403F € 110,50	K53402F € 119,30	K53401F € 141,20	K53403U € 107,90	K53402U € 128,90	K53401U € 143,10
	630x960/2,5	K53406 € 162,80	K53405 € 205,30	K53404 € 236,30	K53406F € 192,90	K53405F € 263,50	K53404F € 280,80	K53406U € 194,40	K53405U € 243,30	K53404U € 270,70
	960x1200/3	K53409 € 260,80	K53408 € 342,40	K53407 € 432,50				K53409U € 323,80	K53408U € 425,10	K53407U € 501,00
Verkehrsfunk § 53/4a 	470x630/2	K534A03 € 85,80	K534A02 € 102,10	K534A01 € 114,50	K534A03F € 110,50	K534A02F € 119,30	K534A01F € 141,20	K534A03U € 107,90	K534A02U € 128,90	K534A01U € 143,10
	630x960/2,5	K534A06 € 162,80	K534A05 € 205,30	K534A04 € 236,30	K534A06F € 192,90	K534A05F € 263,50	K534A04F € 280,80	K534A06U € 194,40	K534A05U € 243,30	K534A04U € 270,70
	960x1200/3	K534A09 € 260,80	K534A08 € 342,40	K534A07 € 432,50				K534A09U € 323,80	K534A08U € 425,10	K534A07U € 501,00
 <p>Verkehrsfunk mit individuellem Logo im Digitaldruck - Preis auf Anfrage!</p>										
Telefon § 53/5 	470x630/2	K53503 € 85,80	K53502 € 102,10	K53501 € 114,50	K53503F € 110,50	K53502F € 119,30	K53501F € 141,20	K53503U € 107,90	K53502U € 128,90	K53501U € 143,10
	630x960/2,5	K53506 € 162,80	K53505 € 205,30	K53504 € 236,30	K53506F € 192,90	K53505F € 263,50	K53504F € 280,80	K53506U € 194,40	K53505U € 243,30	K53504U € 270,70
	960x1200/3	K53509 € 260,80	K53508 € 342,40	K53507 € 432,50				K53509U € 323,80	K53508U € 425,10	K53507U € 501,00
Tankstelle § 53/6 	470x630/2	K53603 € 85,80	K53602 € 102,10	K53601 € 114,50	K53603F € 110,50	K53602F € 119,30	K53601F € 141,20	K53603U € 107,90	K53602U € 128,90	K53601U € 143,10
	630x960/2,5	K53606 € 162,80	K53605 € 205,30	K53604 € 236,30	K53606F € 192,90	K53605F € 263,50	K53604F € 280,80	K53606U € 194,40	K53605U € 243,30	K53604U € 270,70
	960x1200/3	K53609 € 260,80	K53608 € 342,40	K53607 € 432,50				K53609U € 323,80	K53608U € 425,10	K53607U € 501,00
Taxistandplatz § 53/6a 	470x630/2	K536A03 € 85,80	K536A02 € 102,10	K536A01 € 114,50	K536A03F € 110,50	K536A02F € 119,30	K536A01F € 141,20	K536A03U € 107,90	K536A02U € 128,90	K536A01U € 143,10
	630x960/2,5	K536A06 € 162,80	K536A05 € 205,30	K536A04 € 236,30	K536A06F € 192,90	K536A05F € 263,50	K536A04F € 280,80	K536A06U € 194,40	K536A05U € 243,30	K536A04U € 270,70
	960x1200/3	K536A09 € 260,80	K536A08 € 342,40	K536A07 € 432,50				K536A09U € 323,80	K536A08U € 425,10	K536A07U € 501,00
E-Ladestelle § 53/6b 	470x630/2	K536B03 € 85,80	K536B02 € 102,10	K536B01 € 114,50	K536B03F € 110,50	K536B02F € 119,30	K536B01F € 141,20	K536B03U € 107,90	K536B02U € 128,90	K536B01U € 143,10
	630x960/2,5	K536B06 € 162,80	K536B05 € 205,30	K536B04 € 236,30	K536B06F € 192,90	K536B05F € 263,50	K536B04F € 280,80	K536B06U € 194,40	K536B05U € 243,30	K536B04U € 270,70
	960x1200/3	K536B09 € 260,80	K536B08 € 342,40	K536B07 € 432,50				K536B09U € 323,80	K536B08U € 425,10	K536B07U € 501,00

HINWEISZEICHEN § 53	MASSE/ STÄRKE MM	AUSFÜHRUNG FLACH			AUSFÜHRUNG FORMLINE			AUSFÜHRUNG ALFORM		
		Folie EGP	Folie HIP	Folie DGV	Folie EGP	Folie HIP	Folie DGV	Folie EGP	Folie HIP	Folie DGV
		Type 1	Type 2	Type 3	Type 1	Type 2	Type 3	Type 1	Type 2	Type 3
Ende des Gegenverkehrs § 53/7 	470x470/2	K53703 € 50,10	K53702 € 70,20	K53701 € 86,70	K53703F € 93,20	K53702F € 100,60	K53701F € 105,80	K53703U € 86,20	K53702U € 106,00	K53701U € 125,50
	630x630/2	K53706 € 84,30	K53705 € 118,80	K53704 € 141,90	K53706F € 173,50	K53705F € 185,30	K53704F € 194,40	K53706U € 120,60	K53705U € 156,80	K53704U € 191,10
	960x960/2,5	K53709 € 203,30	K53708 € 293,30	K53707 € 365,20				K53709U € 252,50	K53708U € 353,20	K53707U € 415,50
Wartepflicht für Gegenverkehr § 53/7a 	470x470/2	K537A03 € 50,10	K537A02 € 70,20	K537A01 € 86,70	K537A03F € 93,20	K537A02F € 100,60	K537A01F € 105,80	K537A03U € 86,20	K537A02U € 106,00	K537A01U € 125,50
	630x630/2	K537A06 € 84,30	K537A05 € 118,80	K537A04 € 141,90	K537A06F € 173,50	K537A05F € 185,30	K537A04F € 194,40	K537A06U € 120,60	K537A05U € 156,80	K537A04U € 191,10
	960x960/2,5	K537A09 € 203,30	K537A08 € 293,30	K537A07 € 365,20				K537A09U € 252,50	K537A08U € 353,20	K537A07U € 415,50
Autobahn § 53/8a 	960x1200/3		K538A08 € 342,40	K538A07 € 432,50					K538A08U € 425,10	K538A07U € 501,00
Ende der Autobahn § 53/8b 	960x1200/3		K538B09 € 260,80	K538B08 € 342,40	K538B07 € 432,50			K538B09U € 323,80	K538B08U € 425,10	K538B07U € 501,00
Autostraße § 53/8c 	960x1200/3		K538C08 € 342,40	K538C07 € 432,50					K538C08U € 425,10	K538C07U € 501,00
Ende der Autostraße § 53/8d 	960x1200/3		K538D09 € 260,80	K538D08 € 342,40	K538D07 € 432,50			K538D09U € 323,80	K538D08U € 425,10	K538D07U € 501,00
Fußgängerzone § 53/9a 	470x630/2	K539A03 € 85,80	K539A02 € 102,10	K539A01 € 114,50	K539A03F € 110,50	K539A02F € 119,30	K539A01F € 141,20	K539A03U € 107,90	K539A02U € 128,90	K539A01U € 143,10
	630x960/2,5	K539A06 € 162,80	K539A05 € 205,30	K539A04 € 236,30	K539A06F € 192,90	K539A05F € 263,50	K539A04F € 280,80	K539A06U € 194,40	K539A05U € 243,30	K539A04U € 270,70
	960x1200/3	K539A09 € 260,80	K539A08 € 342,40	K539A07 € 432,50				K539A09U € 323,80	K539A08U € 425,10	K539A07U € 501,00



VERKEHRSZEICHEN

HINWEISZEICHEN § 53	MASSE/ STÄRKE MM	AUSFÜHRUNG FLACH			AUSFÜHRUNG FORMLINE			AUSFÜHRUNG ALFORM		
		Folie EGP	Folie HIP	Folie DGV	Folie EGP	Folie HIP	Folie DGV	Folie EGP	Folie HIP	Folie DGV
		Type 1	Type 2	Type 3	Type 1	Type 2	Type 3	Type 1	Type 2	Type 3
Ende einer Fußgängerzone § 53/9b 	470x630/2	K539B03 € 85,80	K539B02 € 102,10	K539B01 € 114,50	K539B03F € 110,50	K539B02F € 119,30	K539B01F € 141,20	K539B03U € 107,90	K539B02U € 128,90	K539B01U € 143,10
	630x960/2,5	K539B06 € 162,80	K539B05 € 205,30	K539B04 € 236,30	K539B06F € 192,90	K539B05F € 263,50	K539B04F € 280,80	K539B06U € 194,40	K539B05U € 243,30	K539B04U € 270,70
	960x1200/3	K539B09 € 260,80	K539B08 € 342,40	K539B07 € 432,50				K539B09U € 323,80	K539B08U € 425,10	K539B07U € 501,00
Wohnstraße § 53/9c 	630x470/2	K539C03 € 85,80	K539C02 € 102,10	K539C01 € 114,50	K539C03F € 110,50	K539C02F € 119,30	K539C01F € 141,20	K539C03U € 107,90	K539C02U € 128,90	K539C01U € 143,10
	960x630/2,5	K539C06 € 162,80	K539C05 € 205,30	K539C04 € 236,30	K539C06F € 192,90	K539C05F € 263,50	K539C04F € 280,80	K539C06U € 194,40	K539C05U € 243,30	K539C04U € 270,70
	1200x960/3	K539C09 € 260,80	K539C08 € 342,40	K539C07 € 432,50				K539C09U € 323,80	K539C08U € 425,10	K539C07U € 501,00
Ende der Wohnstraße § 53/9d 	630x470/2	K539D03 € 85,80	K539D02 € 102,10	K539D01 € 114,50	K539D03F € 110,50	K539D02F € 119,30	K539D01F € 141,20	K539D03U € 107,90	K539D02U € 128,90	K539D01U € 143,10
	960x630/2,5	K539D06 € 162,80	K539D05 € 205,30	K539D04 € 236,30	K539D06F € 192,90	K539D05F € 263,50	K539D04F € 280,80	K539D06U € 194,40	K539D05U € 243,30	K539D04U € 270,70
	1200x960/3	K539D09 € 260,80	K539D08 € 342,40	K539D07 € 432,50				K539D09U € 323,80	K539D08U € 425,10	K539D07U € 501,00
Begegnungszone § 53/9e 	470x630/2	K539E03 € 85,80	K539E02 € 102,10	K539E01 € 114,50	K539E03F € 110,50	K539E02F € 119,30	K539E01F € 141,20	K539E03U € 107,90	K539E02U € 128,90	K539E01U € 143,10
	630x960/2,5	K539E06 € 162,80	K539E05 € 205,30	K539E04 € 236,30	K539E06F € 192,90	K539E05F € 263,50	K539E04F € 280,80	K539E06U € 194,40	K539E05U € 243,30	K539E04U € 270,70
	960x1200/3	K539E09 € 260,80	K539E08 € 342,40	K539E07 € 432,50				K539E09U € 323,80	K539E08U € 425,10	K539E07U € 501,00
Ende einer Begegnungszone § 53/9f 	470x630/2	K539F03 € 85,80	K539F02 € 102,10	K539F01 € 114,50	K539F03F € 110,50	K539F02F € 119,30	K539F01F € 141,20	K539F03U € 107,90	K539F02U € 128,90	K539F01U € 143,10
	630x960/2,5	K539F06 € 162,80	K539F05 € 205,30	K539F04 € 236,30	K539F06F € 192,90	K539F05F € 263,50	K539F04F € 280,80	K539F06U € 194,40	K539F05U € 243,30	K539F04U € 270,70
	960x1200/3	K539F09 € 260,80	K539F08 € 342,40	K539F07 € 432,50				K539F09U € 323,80	K539F08U € 425,10	K539F07U € 501,00
Tunnel § 53/9g 	470x630/2	K539G03 € 85,80	K539G02 € 102,10	K539G01 € 114,50	K539G03F € 110,50	K539G02F € 119,30	K539G01F € 141,20	K539G03U € 107,90	K539G02U € 128,90	K539G01U € 143,10
	630x960/2,5	K539G06 € 162,80	K539G05 € 205,30	K539G04 € 236,30	K539G06F € 192,90	K539G05F € 263,50	K539G04F € 280,80	K539G06U € 194,40	K539G05U € 243,30	K539G04U € 270,70
	960x1200/3	K539G09 € 260,80	K539G08 € 342,40	K539G07 € 432,50				K539G09U € 323,80	K539G08U € 425,10	K539G07U € 501,00
	1000x1500/3	K539G12 € 378,90	K539G11 € 519,80	K539G10 € 597,30				K539G12U € 432,30	K539G11U € 565,40	K539G10U € 647,40
Einbahnstraße § 53/10 	960x310/2 rechts	K5310R03 € 64,90	K5310R02 € 91,10	K5310R01 € 126,30	K5310R03F € 101,90	K5310R02F € 110,70	K5310R01F € 142,80	K5310R03U € 98,80	K5310R02U € 123,00	K5310R01U € 159,90
	960x310/2 links	K5310L03 € 64,90	K5310L02 € 91,10	K5310L01 € 126,30	K5310L03F € 101,90	K5310L02F € 110,70	K5310L01F € 142,80	K5310L03U € 98,80	K5310L02U € 123,00	K5310L01U € 159,90
Straßenbahn biegt bei rot/gelb ab § 53/10a 	110x330	K5310A06 € 48,00	K5310A05 € 57,60							

HINWEISZEICHEN § 53	MASSE/ STÄRKE MM	AUSFÜHRUNG FLACH			AUSFÜHRUNG FORMLINE			AUSFÜHRUNG ALFORM		
		Folie EGP	Folie HIP	Folie DGV	Folie EGP	Folie HIP	Folie DGV	Folie EGP	Folie HIP	Folie DGV
		Type 1	Type 2	Type 3	Type 1	Type 2	Type 3	Type 1	Type 2	Type 3
Sackgasse § 53/11 	470x470/2	K531103 € 50,10	K531102 € 70,20	K531101 € 86,70	K531103F € 93,20	K531102F € 100,60	K531101F € 105,80	K531103U € 86,20	K531102U € 106,00	K531101U € 125,50
	630x630/2	K531106 € 84,30	K531105 € 118,80	K531104 € 141,90	K531106F € 173,50	K531105F € 185,30	K531104F € 194,40	K531106U € 120,60	K531105U € 156,80	K531104U € 191,10
	960x960/2,5	K531109 € 203,30	K531108 € 293,30	K531107 € 365,20				K531109U € 252,50	K531108U € 353,20	K531107U € 415,50
Sackgasse mit Durchgehmöglichkeit § 53/11a 	470x470/2	K5311A03 € 50,10	K5311A02 € 70,20	K5311A01 € 86,70	K5311A03F € 93,20	K5311A02F € 100,60	K5311A01F € 105,80	K5311A03U € 86,20	K5311A02U € 106,00	K5311A01U € 125,50
	630x630/2	K5311A06 € 84,30	K5311A05 € 118,80	K5311A04 € 141,90	K5311A06F € 173,50	K5311A05F € 185,30	K5311A04F € 194,40	K5311A06U € 120,60	K5311A05U € 156,80	K5311A04U € 191,10
	960x960/2,5	K5311A09 € 203,30	K5311A08 € 293,30	K5311A07 € 365,20				K5311A09U € 252,50	K5311A08U € 353,20	K5311A07U € 415,50
Sackgasse mit Durchfahrmöglichkeit für Radfahrer und Durchgehmöglichkeit § 53/11b 	470x470/2	K5311B03 € 50,10	K5311B02 € 70,20	K5311B01 € 86,70	K5311B03F € 93,20	K5311B02F € 100,60	K5311B01F € 105,80	K5311B03U € 86,20	K5311B02U € 106,00	K5311B01U € 125,50
	630x630/2	K5311B06 € 84,30	K5311B05 € 118,80	K5311B04 € 141,90	K5311B06F € 173,50	K5311B05F € 185,30	K5311B04F € 194,40	K5311B06U € 120,60	K5311B05U € 156,80	K5311B04U € 191,10
	960x960/2,5	K5311B09 € 203,30	K5311B08 € 293,30	K5311B07 € 365,20				K5311B09U € 252,50	K5311B08U € 353,20	K5311B07U € 415,50
Laternen, die die ganze Nacht leuchten § 53/12 	150x70/2	K531206 € 26,30	K531205 € 27,00							

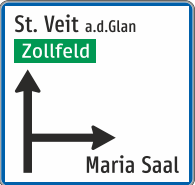
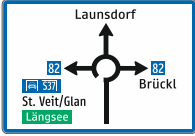
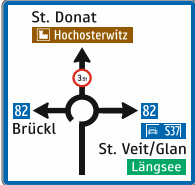
HINWEISZEICHEN § 53	MASSE/ STÄRKE MM	AUSFÜHRUNG FLACH			AUSFÜHRUNG FORMLINE			AUSFÜHRUNG ALFORM		
		Folie EGP	Folie HIP	Folie DGV	Folie EGP	Folie HIP	Folie DGV	Folie EGP	Folie HIP	Folie DGV
		Type 1	Type 2	Type 3	Type 1	Type 2	Type 3	Type 1	Type 2	Type 3
VORWEGWEISER § 53/13a										
Vorwegweiser § 53/13a   	1500x1000/3	K5313A03 € 378,90	K5313A02 € 519,80	K5313A01 € 597,30				K5313A03U € 432,30	K5313A02U € 565,40	K5313A01U € 647,40
	1500x1500/3	K5313A09 € 587,60	K5313A08 € 758,60	K5313A07 € 919,90				K5313A09A € 968,80	K5313A08A € 1.146,70	K5313A07A € 1.228,10
	1500x2000/3							K5313A12A € 1.239,60	K5313A11A € 1.593,40	K5313A10A € 1.788,80
	1500x2500/3							K5313A103A € 1.698,90	K5313A102A € 1.934,10	K5313A101A € 2.128,60
	1500x3000/3							K5313A106A € 1.914,90	K5313A105A € 2.193,30	K5313A104A € 2.419,00
	1500x3500/3							K5313A109A € 2.319,60	K5313A108A € 2.647,10	K5313A107A € 2.915,70
	2000x1000/3	K5313A06 € 488,10	K5313A05 € 691,50	K5313A04 € 813,80				K5313A06U € 513,50	K5313A05U € 681,10	K5313A04U € 786,20
	2000x1500/3	K5313A12 € 698,40	K5313A11 € 940,40	K5313A10 € 1.150,00				K5313A12A € 1.239,60	K5313A11A € 1.593,40	K5313A10A € 1.788,80
	2000x2000/3							K5313A18A € 1.616,80	K5313A17A € 2.032,60	K5313A16A € 2.237,00
	2000x2500/3							K5313A21A € 2.226,40	K5313A20A € 2.544,20	K5313A19A € 2.799,80
	2000x3000/3							K5313A112A € 2.757,40	K5313A111A € 3.233,70	K5313A110A € 3.453,20
	2000x3500/3							K5313A115A € 3.056,30	K5313A114A € 3.602,20	K5313A113A € 3.853,40
	2500x1500/3							K5313A15A € 1.650,20	K5313A14A € 1.946,00	K5313A13A € 2.194,20
	2500x2000/3							K5313A118A € 2.257,30	K5313A117A € 2.655,10	K5313A116A € 2.991,20
	2500x2500/3							K5313A24A € 2.699,20	K5313A23A € 3.189,20	K5313A22A € 3.598,50
	2500x3000/3							K5313A27A € 3.272,70	K5313A26A € 3.862,60	K5313A25A € 4.356,70



VERKEHRSZEICHEN

HINWEISZEICHEN

§ 53

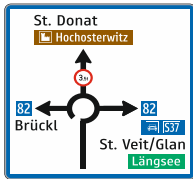

	AUSFÜHRUNG FLACH			AUSFÜHRUNG FORMLINE			AUSFÜHRUNG ALFORM		
	Folie EGP	Folie HIP	Folie DGV	Folie EGP	Folie HIP	Folie DGV	Folie EGP	Folie HIP	Folie DGV
	Type 1	Type 2	Type 3	Type 1	Type 2	Type 3	Type 1	Type 2	Type 3
2500x3500/3							K5313A121A € 3.893,40	K5313A120A € 4.586,20	K5313A119A € 5.169,30
2500x4000/3							K5313A124A € 4.348,90	K5313A123A € 5.134,70	K5313A122A € 5.792,20
3000x1500/3							K5313A127A € 1.956,90	K5313A126A € 2.310,50	K5313A125A € 2.606,40
3000x2000/3							K5313A130A € 2.682,30	K5313A129A € 3.158,00	K5313A128A € 3.559,00
3000x2500/3							K5313A133A € 3.203,70	K5313A132A € 3.789,60	K5313A131A € 4.277,60
3000x3000/3							K5313A30A € 3.905,30	K5313A29A € 4.611,90	K5313A28A € 5.202,90
3000x3500/3							K5313A33A € 4.606,00	K5313A32A € 5.433,40	K5313A31A € 6.127,20
3000x4000/3							K5313A36A € 5.165,60	K5313A35A € 6.105,40	K5313A34A € 6.889,70
3500x1500/3							K5313A136A € 2.510,10	K5313A135A € 2.936,00	K5313A134A € 3.301,20
3500x2000/3							K5313A139A € 3.217,70	K5313A138A € 3.778,00	K5313A137A € 4.253,50
3500x2500/3							K5313A39A € 3.884,50	K5313A38A € 4.576,70	K5313A37A € 5.159,00
3500x3000/3							K5313A42A € 4.698,50	K5313A41A € 5.531,30	K5313A40A € 6.233,40
3500x3500/3							K5313A45A € 5.523,00	K5313A44A € 6.497,00	K5313A43A € 7.319,70
3500x4000/3							K5313A48A € 6.203,30	K5313A47A € 7.310,20	K5313A46A € 8.240,80
3500x4500/3							K5313A51A € 7.006,30	K5313A50A € 8.253,10	K5313A49A € 9.302,50
3500x5000/3							K5313A54A € 7.852,80	K5313A53A € 9.242,20	K5313A52A € 10.414,20
4000x1500/3							K5313A142A € 2.592,50	K5313A141A € 3.062,90	K5313A140A € 3.455,90
4000x2000/3							K5313A145A € 3.642,70	K5313A144A € 4.280,90	K5313A143A € 4.821,30
4000x2500/3							K5313A148A € 4.389,00	K5313A147A € 5.177,10	K5313A146A € 5.838,10
4000x3000/3							K5313A151A € 5.306,40	K5313A150A € 6.254,50	K5313A149A € 7.051,30
4000x3500/3							K5313A154A € 6.273,80	K5313A153A € 7.384,80	K5313A152A € 8.321,60
4000x4000/3							K5313A57A € 7.020,10	K5313A56A € 8.281,00	K5313A55A € 9.338,40
4000x4500/3							K5313A60A € 7.937,50	K5313A59A € 9.358,40	K5313A58A € 10.551,50
4000x5000/3							K5313A63A € 8.904,90	K5313A62A € 10.488,60	K5313A61A € 11.821,80

Alle Vorwegweiser und Wegweiser werden mit einer speziellen Software entworfen und sind so garantiert gemäß RVS ausgeführt!

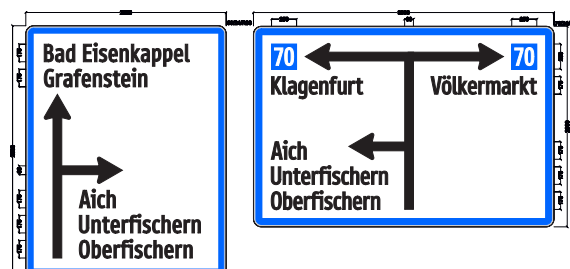

HINWEISZEICHEN § 53

MASSE/
STÄRKE
MM

AUSFÜHRUNG FLACH

AUSFÜHRUNG FORMLINE

AUSFÜHRUNG ALFORM

Folie EGP
Type 1

Folie HIP
Type 2

Folie DGV
Type 3

Folie EGP
Type 1

Folie HIP
Type 2

Folie DGV
Type 3

Folie EGP
Type 1

Folie HIP
Type 2

Folie DGV
Type 3

WEGWEISER § 53

WEISERFORMATE gemäß RVS 05.02.12

Schrifthöhen und Tafelmate (Auszug aus der RVS 05.02.12):

Die Schrifthöhe der Wegweisung hängt von der erlaubten Höchstgeschwindigkeit ab. Die zu verwendenden Schrifthöhen sind der Tabelle zu entnehmen.

Die Tafelgrößen sind entsprechend der Anzahl und der Länge der Zielangaben in Abhängigkeit von der zu verwendenden Mindestschrifthöhe zu wählen.

Schrifthöhen			
km/h	Wegweiser	Vorwegweiser Mindestschrifthöhe	Vorwegweiser empfohlene Schrifthöhe
≤ 30 km/h	105 mm	105 mm	126 mm
31 - 50 km/h	126 mm	126 mm	140 mm
51 - 80 km/h	140 mm	140 mm	175 mm
81 - 100 km/h	175 mm	175 mm	210 mm
> 100 km/h	210 mm	210 mm	280 mm









WEGWEISER			
Schrifthöhe mm	Tafelformat mm	Randbreite mm	Einsätze (Straßen-Nr.)
105	1150x250	15	ohne Einsatz
	1150x400		ohne Einsatz
	1150x620		ohne Einsatz
	1460x250		mit Einsatz
	1460x400		mit Einsatz
	1460x620		mit Einsatz
126	1460x330	20	ohne Einsatz
	1460x500		ohne Einsatz
	1460x660		ohne Einsatz
	1740x330		mit Einsatz
	1740x500		mit Einsatz
	1740x660		mit Einsatz
140	1740x330	25	ohne Einsatz
	1740x500		ohne Einsatz
	1740x750		ohne Einsatz
	2200x330		mit Einsatz
	2200x500		mit Einsatz
	2200x750		mit Einsatz
175	2200x400	30	ohne Einsatz
	2200x660		ohne Einsatz
	2200x900		ohne Einsatz
	2500x400		mit Einsatz
	2500x660		mit Einsatz
	2500x900		mit Einsatz

HINWEISZEICHEN § 53	MASSE/ STÄRKE MM	AUSFÜHRUNG FLACH			AUSFÜHRUNG FORMLINE			AUSFÜHRUNG ALFORM				
		Folie EGP	Folie HIP	Folie DGV	Folie EGP	Folie HIP	Folie DGV	Folie EGP	Folie HIP	Folie DGV		
		Type 1	Type 2	Type 3	Type 1	Type 2	Type 3	Type 1	Type 2	Type 3		
§ 53/13b WEGWEISER, Schrifthöhe 105 mm												
		1150x250/2	K5313B10503 € 95,50	K5313B10502 € 121,50	K5313B10501 € 137,80	K5313B10503F € 115,00	K5313B10502F € 152,00	K5313B10501F € 168,00	K5313B10503U € 139,30	K5313B10502U € 167,40	K5313B10501U € 183,00	
			1150x400/2	K5313B10506 € 127,80	K5313B10505 € 167,40	K5313B10504 € 191,50	K5313B10506F € 162,40	K5313B10505F € 200,90	K5313B10504F € 223,30	K5313B10506U € 169,10	K5313B10505U € 209,40	K5313B10504U € 231,20
				1150x620/2	K5313B10509 € 194,00	K5313B10508 € 255,50	K5313B10507 € 292,90				K5313B10509U € 257,40	K5313B10508U € 313,30
	1460x250/2	K5313B10515 € 121,20		K5313B10514 € 159,00	K5313B10513 € 186,90				K5313B10515U € 158,10	K5313B10514U € 202,40	K5313B10513U € 221,70	
		1460x400/2	K5313B10518 € 181,40	K5313B10517 € 220,50	K5313B10516 € 236,10				K5313B10518U € 249,50	K5313B10517U € 284,20	K5313B10516U € 298,10	
			1460x620/2	K5313B10521 € 323,20	K5313B10520 € 395,40	K5313B10519 € 426,50				K5313B10521U € 390,40	K5313B10520U € 457,40	K5313B10519U € 484,20
§ 53/13b WEGWEISER, Schrifthöhe 126 mm												
		1460x330/2	K5313B12603 € 133,50	K5313B12602 € 183,30	K5313B12601 € 201,00				K5313B12603U € 204,20	K5313B12602U € 244,70	K5313B12601U € 275,10	
			1460x500/2	K5313B12606 € 195,90	K5313B12605 € 258,20	K5313B12604 € 296,10				K5313B12606U € 263,20	K5313B12605U € 328,10	K5313B12604U € 379,40
				1460x660/2,5	K5313B12609 € 329,70	K5313B12608 € 385,00	K5313B12607 € 412,40				K5313B12609U € 402,60	K5313B12608U € 466,90
	1740x330/3	K5313B12615 € 184,60		K5313B12614 € 239,80	K5313B12613 € 272,30				K5313B12615U € 251,40	K5313B12614U € 321,40	K5313B12613U € 335,10	
		1740x500/3	K5313B12618 € 251,00	K5313B12617 € 339,10	K5313B12616 € 377,90				K5313B12618U € 315,90	K5313B12617U € 412,30	K5313B12616U € 432,70	
			1740x660/3	K5313B12621 € 426,60	K5313B12620 € 511,20	K5313B12619 € 545,10				K5313B12621U € 448,10	K5313B12620U € 554,50	K5313B12619U € 610,80

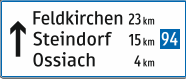
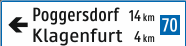

SCHILDER VON WELT MIT UMWELTEFFEKT.

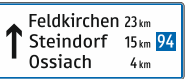

HINWEISZEICHEN § 53	MASSE/ STÄRKE MM	AUSFÜHRUNG FLACH			AUSFÜHRUNG FORMLINE			AUSFÜHRUNG ALFORM		
		Folie EGP	Folie HIP	Folie DGV	Folie EGP	Folie HIP	Folie DGV	Folie EGP	Folie HIP	Folie DGV
		Type 1	Type 2	Type 3	Type 1	Type 2	Type 3	Type 1	Type 2	Type 3
§ 53/13b WEGWEISER, Schrifthöhe 140 mm										
  	1740x330/3	K5313B14003 € 184,60	K5313B14002 € 239,80	K5313B14001 € 272,30				K5313B14003U € 251,40	K5313B14002U € 321,40	K5313B14001U € 335,10
	1740x500/3	K5313B14006 € 251,00	K5313B14005 € 339,10	K5313B14004 € 377,90				K5313B14006U € 315,90	K5313B14005U € 412,30	K5313B14004U € 432,70
	1740x750/3	K5313B14009 € 445,30	K5313B14008 € 532,10	K5313B14007 € 604,60				K5313B14009U € 517,40	K5313B14008U € 625,50	K5313B14007U € 689,30
  	2200x330/3	K5313B14015 € 236,20	K5313B14014 € 307,60	K5313B14013 € 334,20				K5313B14015U € 292,10	K5313B14014U € 376,80	K5313B14013U € 413,70
	2200x500/3	K5313B14018 € 329,20	K5313B14017 € 423,50	K5313B14016 € 472,40				K5313B14018U € 431,80	K5313B14017U € 520,40	K5313B14016U € 573,60
	2200x750/3	K5313B14021 € 501,70	K5313B14020 € 618,10	K5313B14019 € 690,50				K5313B14021U € 612,10	K5313B14020U € 746,40	K5313B14019U € 824,80
§ 53/13b WEGWEISER, Schrifthöhe 175 mm										
  	2200x400/3	K5313B17503 € 299,90	K5313B17502 € 342,30	K5313B17501 € 390,00				K5313B17503U € 353,00	K5313B17502U € 423,40	K5313B17501U € 444,10
	2200x660/3	K5313B17506 € 453,60	K5313B17505 € 608,60	K5313B17504 € 676,60				K5313B17506U € 535,60	K5313B17505U € 667,00	K5313B17504U € 753,40
	2200x900/3	K5313B17509 € 602,00	K5313B17508 € 810,70	K5313B17507 € 902,30				K5313B17509U € 691,40	K5313B17508U € 867,00	K5313B17507U € 981,30
  	2500x400/3	K5313B17515 € 321,10	K5313B17514 € 399,00	K5313B17513 € 443,90				K5313B17515A € 461,30	K5313B17514A € 560,50	K5313B17513A € 626,10
	2500x660/3	K5313B17518 € 493,80	K5313B17517 € 620,50	K5313B17516 € 692,80				K5313B17518A € 662,40	K5313B17517A € 819,10	K5313B17516A € 920,30
	2500x900/3	K5313B17521 € 638,40	K5313B17520 € 809,50	K5313B17519 € 906,30				K5313B17521A € 820,00	K5313B17520A € 1.027,70	K5313B17519A € 1.159,70

WIR FÜHREN NUR GUTES IM SCHILDE.















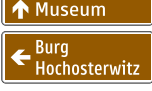
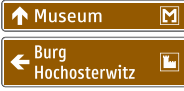
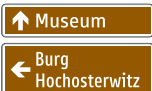
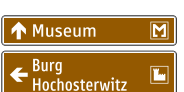

ITEK

HINWEISZEICHEN § 53	MASSE/ STÄRKE MM	AUSFÜHRUNG FLACH			AUSFÜHRUNG FORMLINE			AUSFÜHRUNG ALFORM			
		Folie EGP	Folie HIP	Folie DGV	Folie EGP	Folie HIP	Folie DGV	Folie EGP	Folie HIP	Folie DGV	
		Type 1	Type 2	Type 3	Type 1	Type 2	Type 3	Type 1	Type 2	Type 3	
§ 53/13c WEGWEISER ZU ANDEREN VERKEHRSEINRICHTUNGEN, Schriftgröße 105 mm											
	 	1150x250/2	K5313C10503 € 95,50	K5313C10502 € 121,50	K5313C10501 € 137,80	K5313C10503F € 115,00	K5313C10502F € 152,00	K5313C10501F € 168,00	K5313C10503U € 139,30	K5313C10502U € 167,40	K5313C10501U € 183,00
		1150x400/2	K5313C10506 € 127,80	K5313C10505 € 167,40	K5313C10504 € 191,50	K5313C10506F € 162,40	K5313C10505F € 200,90	K5313C10504F € 223,30	K5313C10506U € 169,10	K5313C10505U € 209,40	K5313C10504U € 231,20
 	1460x250/2	K5313C10515 € 121,20	K5313C10514 € 159,00	K5313C10513 € 186,90				K5313C10515U € 158,10	K5313C10514U € 202,40	K5313C10513U € 221,70	
	1460x400/2	K5313C10518 € 181,40	K5313C10517 € 220,50	K5313C10516 € 236,10				K5313C10518U € 249,50	K5313C10517U € 284,20	K5313C10516U € 298,10	
§ 53/13c WEGWEISER ZU ANDEREN VERKEHRSEINRICHTUNGEN, Schriftgröße 126 mm											
	 	1460x330/2	K5313C12603 € 133,50	K5313C12602 € 183,30	K5313C12601 € 201,00				K5313C12603U € 204,20	K5313C12602U € 244,70	K5313C12601U € 275,10
		1460x500/2	K5313C12606 € 195,90	K5313C12605 € 258,20	K5313C12604 € 296,10				K5313C12606U € 263,20	K5313C12605U € 328,10	K5313C12604U € 379,40
 	1740x330/3	K5313C12615 € 184,60	K5313C12614 € 239,80	K5313C12613 € 272,30				K5313C12615U € 251,40	K5313C12614U € 321,40	K5313C12613U € 335,10	
	1740x500/3	K5313C12618 € 251,00	K5313C12617 € 339,10	K5313C12616 € 377,90				K5313C12618U € 315,90	K5313C12617U € 412,30	K5313C12616U € 432,70	
§ 53/13c WEGWEISER ZU ANDEREN VERKEHRSEINRICHTUNGEN, Schriftgröße 140 mm											
	 	1740x330/3	K5313C14003 € 184,60	K5313C14002 € 239,80	K5313C14001 € 272,30				K5313C14003U € 251,40	K5313C14002U € 321,40	K5313C14001U € 335,10
		1740x500/3	K5313C14006 € 251,00	K5313C14005 € 339,10	K5313C14004 € 377,90				K5313C14006U € 315,90	K5313C14005U € 412,30	K5313C14004U € 432,70
 	2200x330/3	K5313C14015 € 236,20	K5313C14014 € 307,60	K5313C14013 € 334,20				K5313C14015U € 292,10	K5313C14014U € 376,80	K5313C14013U € 413,70	
	2200x500/3	K5313C14018 € 329,20	K5313C14017 € 423,50	K5313C14016 € 472,40				K5313C14018U € 431,80	K5313C14017U € 520,40	K5313C14016U € 573,60	
§ 53/13c WEGWEISER ZU ANDEREN VERKEHRSEINRICHTUNGEN, Schriftgröße 175 mm											
	 	2200x400/3	K5313C17503 € 299,90	K5313C17502 € 342,30	K5313C17501 € 390,00				K5313C17503U € 353,00	K5313C17502U € 423,40	K5313C17501U € 444,10
		2200x660/3	K5313C17506 € 453,60	K5313C17505 € 608,60	K5313C17504 € 676,60				K5313C17506U € 535,60	K5313C17505U € 667,00	K5313C17504U € 753,40
 	2500x400/3	K5313C17515 € 321,10	K5313C17514 € 399,00	K5313C17513 € 443,90				K5313C17515A € 461,30	K5313C17514A € 560,50	K5313C17513A € 626,10	
	2500x660/3	K5313C17518 € 493,80	K5313C17517 € 620,50	K5313C17516 € 692,80				K5313C17518A € 662,40	K5313C17517A € 819,10	K5313C17516A € 920,30	

HINWEISZEICHEN § 53	MASSE/ STÄRKE MM	AUSFÜHRUNG FLACH			AUSFÜHRUNG FORMLINE			AUSFÜHRUNG ALFORM			
		Folie EGP	Folie HIP	Folie DGV	Folie EGP	Folie HIP	Folie DGV	Folie EGP	Folie HIP	Folie DGV	
		Type 1	Type 2	Type 3	Type 1	Type 2	Type 3	Type 1	Type 2	Type 3	
§ 53/13d WEGWEISER ZU LOKAL BED. ZIELEN, Schriftgröße 105 mm											
	← Minimundus	1150x250/2	K5313D10503	K5313D10502	K5313D10501	K5313D10503F	K5313D10502F	K5313D10501F	K5313D10503U	K5313D10502U	K5313D10501U
			€ 95,50	€ 121,50	€ 137,80	€ 115,00	€ 152,00	€ 168,00	€ 139,30	€ 167,40	€ 183,00
	← Gemeindeamt Information	1150x400/2	K5313D10506	K5313D10505	K5313D10504	K5313D10506F	K5313D10505F	K5313D10504F	K5313D10506U	K5313D10505U	K5313D10504U
			€ 127,80	€ 167,40	€ 191,50	€ 162,40	€ 200,90	€ 223,30	€ 169,10	€ 209,40	€ 231,20
	← Tourismusbüro	1460x250/2	K5313D10515	K5313D10514	K5313D10513				K5313D10515U	K5313D10514U	K5313D10513U
			€ 121,20	€ 159,00	€ 186,90				€ 158,10	€ 202,40	€ 221,70
	← Gemeindeamt Tourismusbüro	1460x400/2	K5313D10518	K5313D10517	K5313D10516				K5313D10518U	K5313D10517U	K5313D10516U
			€ 181,40	€ 220,50	€ 236,10				€ 249,50	€ 284,20	€ 298,10
§ 53/13d WEGWEISER ZU LOKAL BED. ZIELEN, Schriftgröße 126 mm											
	← Minimundus	1460x330/2	K5313D12603	K5313D12602	K5313D12601				K5313D12603U	K5313D12602U	K5313D12601U
			€ 133,50	€ 183,30	€ 201,00				€ 204,20	€ 244,70	€ 275,10
	← Gemeindeamt Information	1460x500/2	K5313D12606	K5313D12605	K5313D12604				K5313D12606U	K5313D12605U	K5313D12604U
			€ 195,90	€ 258,20	€ 296,10				€ 263,20	€ 328,10	€ 379,40
	← Tourismusbüro	1740x330/3	K5313D12615	K5313D12614	K5313D12613				K5313D12615U	K5313D12614U	K5313D12613U
			€ 184,60	€ 239,80	€ 272,30				€ 251,40	€ 321,40	€ 335,10
	← Gemeindeamt Tourismusbüro	1740x500/3	K5313D12618	K5313D12617	K5313D12616				K5313D12618U	K5313D12617U	K5313D12616U
			€ 251,00	€ 339,10	€ 377,90				€ 315,90	€ 412,30	€ 432,70
§ 53/13d WEGWEISER ZU LOKAL BED. ZIELEN, Schriftgröße 140 mm											
	← Minimundus	1740x330/3	K5313D14003	K5313D14002	K5313D14001				K5313D14003U	K5313D14002U	K5313D14001U
			€ 184,60	€ 239,80	€ 272,30				€ 251,40	€ 321,40	€ 335,10
	← Gemeindeamt Information	1740x500/3	K5313D14006	K5313D14005	K5313D14004				K5313D14006U	K5313D14005U	K5313D14004U
			€ 251,00	€ 339,10	€ 377,90				€ 315,90	€ 412,30	€ 432,70
	← Tourismusbüro	2200x330/3	K5313D14015	K5313D14014	K5313D14013				K5313D14015U	K5313D14014U	K5313D14013U
			€ 236,20	€ 307,60	€ 334,20				€ 292,10	€ 376,80	€ 413,70
	← Gemeindeamt Tourismusbüro	2200x500/3	K5313D14018	K5313D14017	K5313D14016				K5313D14018U	K5313D14017U	K5313D14016U
			€ 329,20	€ 423,50	€ 472,40				€ 431,80	€ 520,40	€ 573,60
§ 53/13d WEGWEISER ZU LOKAL BED. ZIELEN, Schriftgröße 175 mm											
	← Minimundus	2200x400/3	K5313D17503	K5313D17502	K5313D17501				K5313D17503U	K5313D17502U	K5313D17501U
			€ 299,90	€ 342,30	€ 390,00				€ 353,00	€ 423,40	€ 444,10
	← Gemeindeamt Information	2200x660/3	K5313D17506	K5313D17505	K5313D17504				K5313D17506U	K5313D17505U	K5313D17504U
			€ 453,60	€ 608,60	€ 676,60				€ 535,60	€ 667,00	€ 753,40
	← Tourismusbüro	2500x400/3	K5313D17515	K5313D17514	K5313D17513				K5313D17515A	K5313D17514A	K5313D17513A
			€ 321,10	€ 399,00	€ 443,90				€ 461,30	€ 560,50	€ 626,10
	← Gemeindeamt Tourismusbüro	2500x660/3	K5313D17518	K5313D17517	K5313D17516				K5313D17518A	K5313D17517A	K5313D17516A
			€ 493,80	€ 620,50	€ 692,80				€ 662,40	€ 819,10	€ 920,30
§ 53/13d WEGWEISER ZU BETRIEBEN IM INTERESSE VON GEMEINDEN, FREMDENVERKEHR UND SPORT, Schriftgröße 105 mm											
	↑ Fischerwirt	1150x250/2	K5313D10521	K5313D10520	K5313D10519	K5313D10521F	K5313D10520F	K5313D10519F	K5313D10521U	K5313D10520U	K5313D10519U
			€ 95,50	€ 121,50	€ 137,80	€ 115,00	€ 152,00	€ 168,00	€ 139,30	€ 167,40	€ 183,00
	↗ Fischerwirt ↗	1460x250/2	K5313D10524	K5313D10523	K5313D10522				K5313D10524U	K5313D10523U	K5313D10522U
			€ 121,20	€ 159,00	€ 186,90				€ 158,10	€ 202,40	€ 221,70
Standard-Logo in grün/weiss: Aufpreis € 35,00 netto Wegweiser mit individuellem Logo: Verrechnung nach tatsächlichem Aufwand											

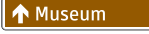

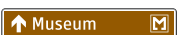
HINWEISZEICHEN § 53		MASSE/ STÄRKE MM	AUSFÜHRUNG FLACH			AUSFÜHRUNG FORMLINE			AUSFÜHRUNG ALFORM		
			Folie EGP	Folie HIP	Folie DGV	Folie EGP	Folie HIP	Folie DGV	Folie EGP	Folie HIP	Folie DGV
			Type 1	Type 2	Type 3	Type 1	Type 2	Type 3	Type 1	Type 2	Type 3
§ 53/13 lt. RVS WEGWEISER FÜR GEWERBE UND INDUSTRIE, Schrifthöhe 105 mm											
	Gewerbezone	1150x250/2	K5313G10503 € 95,50	K5313G10502 € 121,50	K5313G10501 € 137,80	K5313G10503F € 115,00	K5313G10502F € 152,00	K5313G10501F € 168,00	K5313G10503U € 139,30	K5313G10502U € 167,40	K5313G10501U € 183,00
		1150x400/2	K5313G10506 € 127,80	K5313G10505 € 167,40	K5313G10504 € 191,50	K5313G10506F € 162,40	K5313G10505F € 200,90	K5313G10504F € 223,30	K5313G10506U € 169,10	K5313G10505U € 209,40	K5313G10504U € 231,20
	Gewerbezone Fabrikstraße	1460x250/2	K5313G10515 € 121,20	K5313G10514 € 159,00	K5313G10513 € 186,90				K5313G10515U € 158,10	K5313G10514U € 202,40	K5313G10513U € 221,70
		1460x400/2	K5313G10518 € 181,40	K5313G10517 € 220,50	K5313G10516 € 236,10				K5313G10518U € 249,50	K5313G10517U € 284,20	K5313G10516U € 298,10
§ 53/13 lt. RVS WEGWEISER FÜR GEWERBE UND INDUSTRIE, Schrifthöhe 126 mm											
	Gewerbezone	1460x330/2	K5313G12603 € 133,50	K5313G12602 € 183,30	K5313G12601 € 201,00				K5313G12603U € 204,20	K5313G12602U € 244,70	K5313G12601U € 275,10
		1460x500/2	K5313G12606 € 195,90	K5313G12605 € 258,20	K5313G12604 € 296,10				K5313G12606U € 263,20	K5313G12605U € 328,10	K5313G12604U € 379,40
	Gewerbezone Fabrikstraße	1740x330/3	K5313G12615 € 184,60	K5313G12614 € 239,80	K5313G12613 € 272,30				K5313G12615U € 251,40	K5313G12614U € 321,40	K5313G12613U € 335,10
		1740x500/3	K5313G12618 € 251,00	K5313G12617 € 339,10	K5313G12616 € 377,90				K5313G12618U € 315,90	K5313G12617U € 412,30	K5313G12616U € 432,70
§ 53/13 lt. RVS WEGWEISER FÜR GEWERBE UND INDUSTRIE, Schrifthöhe 140 mm											
	Gewerbezone	1740x330/3	K5313G14003 € 184,60	K5313G14002 € 239,80	K5313G14001 € 272,30				K5313G14003U € 251,40	K5313G14002U € 321,40	K5313G14001U € 335,10
		1740x500/3	K5313G14006 € 251,00	K5313G14005 € 339,10	K5313G14004 € 377,90				K5313G14006U € 315,90	K5313G14005U € 412,30	K5313G14004U € 432,70
	Gewerbezone Fabrikstraße	2200x330/3	K5313G14015 € 236,20	K5313G14014 € 307,60	K5313G14013 € 334,20				K5313G14015U € 292,10	K5313G14014U € 376,80	K5313G14013U € 413,70
		2200x500/3	K5313G14018 € 329,20	K5313G14017 € 423,50	K5313G14016 € 472,40				K5313G14018U € 431,80	K5313G14017U € 520,40	K5313G14016U € 573,60
§ 53/13 lt. RVS WEGWEISER FÜR GEWERBE UND INDUSTRIE, Schrifthöhe 175 mm											
	Gewerbezone	2200x400/3	K5313G17503 € 299,90	K5313G17502 € 342,30	K5313G17501 € 390,00				K5313G17503U € 353,00	K5313G17502U € 423,40	K5313G17501U € 444,10
		2200x660/3	K5313G17506 € 453,60	K5313G17505 € 608,60	K5313G17504 € 676,60				K5313G17506U € 535,60	K5313G17505U € 667,00	K5313G17504U € 753,40
	Gewerbezone Fabrikstraße	2500x400/3	K5313G17515 € 321,10	K5313G17514 € 399,00	K5313G17513 € 443,90				K5313G17515A € 461,30	K5313G17514A € 560,50	K5313G17513A € 626,10
		2500x660/3	K5313G17518 € 493,80	K5313G17517 € 620,50	K5313G17516 € 692,80				K5313G17518A € 662,40	K5313G17517A € 819,10	K5313G17516A € 920,30
§ 53/13d WEGWEISER ZU HANDELS-, GEWERBE- UND INDUSTRIEBETRIEBEN, Schrifthöhe 105 mm											
	KMH Group	1150x250/2	K5313G10521 € 95,50	K5313G10520 € 121,50	K5313G10519 € 137,80	K5313G10521F € 115,00	K5313G10520F € 152,00	K5313G10519F € 168,00	K5313G10521U € 139,30	K5313G10520U € 167,40	K5313G10519U € 183,00
		1460x250/2	K5313G10524 € 121,20	K5313G10523 € 159,00	K5313G10522 € 186,90				K5313G10524U € 158,10	K5313G10523U € 202,40	K5313G10522U € 221,70
	Treibacher Industrie										
<p>Standard-Logo in grün/gelb: Aufpreis € 35,00 netto Wegweiser mit individuellem Logo: Verrechnung nach tatsächlichem Aufwand</p>											

HINWEISZEICHEN § 53	MASSE/ STÄRKE MM	AUSFÜHRUNG FLACH			AUSFÜHRUNG FORMLINE			AUSFÜHRUNG ALFORM			
		Folie EGP	Folie HIP	Folie DGV	Folie EGP	Folie HIP	Folie DGV	Folie EGP	Folie HIP	Folie DGV	
		Type 1	Type 2	Type 3	Type 1	Type 2	Type 3	Type 1	Type 2	Type 3	
    	§ 53/13 ft. RVS WEGWEISER FÜR KULTURELL BED. SEHENSWÜRDIGKEITEN, Schrifthöhe 105 mm										
	1150x250/2	K5313H10503 € 95,50	K5313H10502 € 121,50	K5313H10501 € 137,80	K5313H10503F € 115,00	K5313H10502F € 152,00	K5313H10501F € 168,00	K5313H10503U € 139,30	K5313H10502U € 167,40	K5313H10501U € 183,00	
	1150x400/2	K5313H10506 € 127,80	K5313H10505 € 167,40	K5313H10504 € 191,50	K5313H10506F € 162,40	K5313H10505F € 200,90	K5313H10504F € 223,30	K5313H10506U € 169,10	K5313H10505U € 209,40	K5313H10504U € 231,20	
	1460x250/2	K5313H10515 € 121,20	K5313H10514 € 159,00	K5313H10513 € 186,90				K5313H10515U € 158,10	K5313H10514U € 202,40	K5313H10513U € 221,70	
	1460x400/2	K5313H10518 € 181,40	K5313H10517 € 220,50	K5313H10516 € 236,10				K5313H10518U € 249,50	K5313H10517U € 284,20	K5313H10516U € 298,10	
	    	§ 53/13 ft. RVS WEGWEISER FÜR KULTURELL BED. SEHENSWÜRDIGKEITEN, Schrifthöhe 126 mm									
		1460x330/2	K5313H12603 € 133,50	K5313H12602 € 183,30	K5313H12601 € 201,00				K5313H12603U € 204,20	K5313H12602U € 244,70	K5313H12601U € 275,10
		1460x500/2	K5313H12606 € 195,90	K5313H12605 € 258,20	K5313H12604 € 296,10				K5313H12606U € 263,20	K5313H12605U € 328,10	K5313H12604U € 379,40
		1740x330/3	K5313H12615 € 184,60	K5313H12614 € 239,80	K5313H12613 € 272,30				K5313H12615U € 251,40	K5313H12614U € 321,40	K5313H12613U € 335,10
		1740x500/3	K5313H12618 € 251,00	K5313H12617 € 339,10	K5313H12616 € 377,90				K5313H12618U € 315,90	K5313H12617U € 412,30	K5313H12616U € 432,70
		    	§ 53/13 ft. RVS WEGWEISER FÜR KULTURELL BED. SEHENSWÜRDIGKEITEN, Schrifthöhe 140 mm								
			1740x330/3	K5313H14003 € 184,60	K5313H14002 € 239,80	K5313H14001 € 272,30				K5313H14003U € 251,40	K5313H14002U € 321,40
1740x500/3			K5313H14006 € 251,00	K5313H14005 € 339,10	K5313H14004 € 377,90				K5313H14006U € 315,90	K5313H14005U € 412,30	K5313H14004U € 432,70
2200x330/3			K5313H14015 € 236,20	K5313H14014 € 307,60	K5313H14013 € 334,20				K5313H14015U € 292,10	K5313H14014U € 376,80	K5313H14013U € 413,70
2200x500/3			K5313H14018 € 329,20	K5313H14017 € 423,50	K5313H14016 € 472,40				K5313H14018U € 431,80	K5313H14017U € 520,40	K5313H14016U € 573,60
    			§ 53/13 ft. RVS WEGWEISER FÜR KULTURELL BED. SEHENSWÜRDIGKEITEN, Schrifthöhe 175 mm								
			2200x400/3	K5313H17503 € 299,90	K5313H17502 € 342,30	K5313H17501 € 390,00				K5313H17503U € 353,00	K5313H17502U € 423,40
	2200x660/3		K5313H17506 € 453,60	K5313H17505 € 608,60	K5313H17504 € 676,60				K5313H17506U € 535,60	K5313H17505U € 667,00	K5313H17504U € 753,40
	2500x400/3		K5313H17515 € 321,10	K5313H17514 € 399,00	K5313H17513 € 443,90				K5313H17515A € 461,30	K5313H17514A € 560,50	K5313H17513A € 626,10
	2500x660/3		K5313H17518 € 493,80	K5313H17517 € 620,50	K5313H17516 € 692,80				K5313H17518A € 662,40	K5313H17517A € 819,10	K5313H17516A € 920,30



HINWEISZEICHEN § 53	MASSE/ STÄRKE MM	AUSFÜHRUNG FLACH			AUSFÜHRUNG FORMLINE			AUSFÜHRUNG ALFORM		
		Folie EGP	Folie HIP	Folie DGV	Folie EGP	Folie HIP	Folie DGV	Folie EGP	Folie HIP	Folie DGV
		Type 1	Type 2	Type 3	Type 1	Type 2	Type 3	Type 1	Type 2	Type 3
	§ 53/14b WEGWEISER Schrifthöhe 105 mm									
	1150x250/2	K5314B10503 € 95,50	K5314B10502 € 121,50	K5314B10501 € 137,80	K5314B10503F € 115,00	K5314B10502F € 152,00	K5314B10501F € 168,00	K5314B10503U € 139,30	K5314B10502U € 167,40	K5314B10501U € 183,00
	1150x400/2	K5314B10506 € 127,80	K5314B10505 € 167,40	K5314B10504 € 191,50	K5314B10506F € 162,40	K5314B10505F € 200,90	K5314B10504F € 223,30	K5314B10506U € 169,10	K5314B10505U € 209,40	K5314B10504U € 231,20
	1460x250/2	K5314B10515 € 121,20	K5314B10514 € 159,00	K5314B10513 € 186,90				K5314B10515U € 158,10	K5314B10514U € 202,40	K5314B10513U € 221,70
	1460x400/2	K5314B10518 € 181,40	K5314B10517 € 220,50	K5314B10516 € 236,10				K5314B10518U € 249,50	K5314B10517U € 284,20	K5314B10516U € 298,10
	§ 53/14b WEGWEISER Schrifthöhe 126 mm									
	1460x330/2	K5314B12603 € 133,50	K5314B12602 € 183,30	K5314B12601 € 201,00				K5314B12603U € 204,20	K5314B12602U € 244,70	K5314B12601U € 275,10
	1460x500/2	K5314B12606 € 195,90	K5314B12605 € 258,20	K5314B12604 € 296,10				K5314B12606U € 263,20	K5314B12605U € 328,10	K5314B12604U € 379,40
	1740x330/3	K5314B12615 € 184,60	K5314B12614 € 239,80	K5314B12613 € 272,30				K5314B12615U € 251,40	K5314B12614U € 321,40	K5314B12613U € 335,10
	1740x500/3	K5314B12618 € 251,00	K5314B12617 € 339,10	K5314B12616 € 377,90				K5314B12618U € 315,90	K5314B12617U € 412,30	K5314B12616U € 432,70
	§ 53/14b WEGWEISER Schrifthöhe 140 mm									
	1740x330/3	K5314B14003 € 184,60	K5314B14002 € 239,80	K5314B14001 € 272,30				K5314B14003U € 251,40	K5314B14002U € 321,40	K5314B14001U € 335,10
	1740x500/3	K5314B14006 € 251,00	K5314B14005 € 339,10	K5314B14004 € 377,90				K5314B14006U € 315,90	K5314B14005U € 412,30	K5314B14004U € 432,70
	2200x330/3	K5314B14015 € 236,20	K5314B14014 € 307,60	K5314B14013 € 334,20				K5314B14015U € 292,10	K5314B14014U € 376,80	K5314B14013U € 413,70
	2200x500/3	K5314B14018 € 329,20	K5314B14017 € 423,50	K5314B14016 € 472,40				K5314B14018U € 431,80	K5314B14017U € 520,40	K5314B14016U € 573,60
	§ 53/14b WEGWEISER Schrifthöhe 175 mm									
	2200x400/3	K5314B17503 € 299,90	K5314B17502 € 342,30	K5314B17501 € 390,00				K5314B17503U € 353,00	K5314B17502U € 423,40	K5314B17501U € 444,10
	2200x660/3	K5314B17506 € 453,60	K5314B17505 € 608,60	K5314B17504 € 676,60				K5314B17506U € 535,60	K5314B17505U € 667,00	K5314B17504U € 753,40
	2500x400/3	K5314B17515 € 321,10	K5314B17514 € 399,00	K5314B17513 € 443,90				K5314B17515A € 461,30	K5314B17514A € 560,50	K5314B17513A € 626,10
	2500x660/3	K5314B17518 € 493,80	K5314B17517 € 620,50	K5314B17516 € 692,80				K5314B17518A € 662,40	K5314B17517A € 819,10	K5314B17516A € 920,30

HINWEISZEICHEN § 53	MASSE/ STÄRKE MM	AUSFÜHRUNG FLACH			AUSFÜHRUNG FORMLINE			AUSFÜHRUNG ALFORM		
		Folie EGP	Folie HIP	Folie DGV	Folie EGP	Folie HIP	Folie DGV	Folie EGP	Folie HIP	Folie DGV
		Type 1	Type 2	Type 3	Type 1	Type 2	Type 3	Type 1	Type 2	Type 3
ALTE WEGWEISERFORMATE										
Wegweiser § 53/13b	1150x310/2	K5313B39	K5313B38	K5313B37	K5313B39F	K5313B38F	K5313B37F	K5313B39U	K5313B38U	K5313B37U
		€ 108,80	€ 140,40	€ 159,90	€ 125,90	€ 168,10	€ 186,50	€ 151,50	€ 184,60	€ 202,80
	1460x310/2	K5313B42	K5313B41	K5313B40				K5313B42U	K5313B41U	K5313B40U
		€ 139,90	€ 186,00	€ 219,50				€ 173,50	€ 225,40	€ 248,00
1740x460/3	K5313B45	K5313B44	K5313B43				K5313B45U	K5313B44U	K5313B43U	
	€ 237,20	€ 319,70	€ 356,00				€ 302,50	€ 393,30	€ 412,40	
2200x460/3	K5313B48	K5313B47	K5313B46				K5313B48U	K5313B47U	K5313B46U	
	€ 309,90	€ 397,70	€ 443,30				€ 412,10	€ 494,80	€ 544,80	
Wegweiser zu anderen Verkehrseinrichtungen § 53/13c	1150x310/2	K5313C09	K5313C08	K5313C07	K5313C09F	K5313C08F	K5313C07F	K5313C09U	K5313C08U	K5313C07U
		€ 108,80	€ 140,40	€ 159,90	€ 125,90	€ 168,10	€ 186,50	€ 151,50	€ 184,60	€ 202,80
	1740x460/3	K5313C12	K5313C11	K5313C10				K5313C12U	K5313C11U	K5313C10U
		€ 237,20	€ 319,70	€ 356,00				€ 302,50	€ 393,30	€ 412,40
Wegweiser zu lokal bedeutenden Zielen § 53/13d	1150x310/2	K5313D21	K5313D20	K5313D19	K5313D21F	K5313D20F	K5313D19F	K5313D21U	K5313D20U	K5313D19U
		€ 108,80	€ 140,40	€ 159,90	€ 125,90	€ 168,10	€ 186,50	€ 151,50	€ 184,60	€ 202,80
	1460x310/2	K5313D24	K5313D23	K5313D22				K5313D24U	K5313D23U	K5313D22U
		€ 139,90	€ 186,00	€ 219,50				€ 173,50	€ 225,40	€ 248,00
1740x460/3	K5313D27	K5313D26	K5313D25				K5313D27U	K5313D26U	K5313D25U	
	€ 237,20	€ 319,70	€ 356,00				€ 302,50	€ 393,30	€ 412,40	
Standard-Logo in grün/weiss: Aufpreis € 35,00 netto Wegweiser mit individuellem Logo: Verrechnung nach tatsächlichem Aufwand										
Wegweiser für Gewerbe und Industrie § 53/13	1150x310/2	K5313G21	K5313G20	K5313G19	K5313G21F	K5313G20F	K5313G19F	K5313G21U	K5313G20U	K5313G19U
		€ 108,80	€ 140,40	€ 159,90	€ 125,90	€ 168,10	€ 186,50	€ 151,50	€ 184,60	€ 202,80
	1460x310/2	K5313G24	K5313G23	K5313G22				K5313G24U	K5313G23U	K5313G22U
		€ 139,90	€ 186,00	€ 219,50				€ 173,50	€ 225,40	€ 248,00
1740x460/3	K5313G27	K5313G26	K5313G25				K5313G27U	K5313G26U	K5313G25U	
	€ 237,20	€ 319,70	€ 356,00				€ 302,50	€ 393,30	€ 412,40	
Standard-Logo in grün/gelb: Aufpreis € 35,00 netto Wegweiser mit individuellem Logo: Verrechnung nach tatsächlichem Aufwand										
Wegweiser für kulturell bedeutende Sehenswürdigkeiten § 53/13	1150x310/2	K5313H03	K5313H02	K5313H01	K5313H03F	K5313H02F	K5313H01F	K5313H03U	K5313H02U	K5313H01U
		€ 108,80	€ 140,40	€ 159,90	€ 125,90	€ 168,10	€ 186,50	€ 151,50	€ 184,60	€ 202,80
	1460x310/2	K5313H06	K5313H05	K5313H04				K5313H06U	K5313H05U	K5313H04U
		€ 139,90	€ 186,00	€ 219,50				€ 173,50	€ 225,40	€ 248,00
1740x460/3	K5313H09	K5313H08	K5313H07				K5313H09U	K5313H08U	K5313H07U	
	€ 237,20	€ 319,70	€ 356,00				€ 302,50	€ 393,30	€ 412,40	
Wegweiser zur Autobahn oder Autostraße §53/14b	1150x310/2	K5314B39	K5314B38	K5314B37	K5314B39F	K5314B38F	K5314B37F	K5314B39U	K5314B38U	K5314B37U
		€ 108,80	€ 140,40	€ 159,90	€ 125,90	€ 168,10	€ 186,50	€ 151,50	€ 184,60	€ 202,80
	1460x310/2	K5314B42	K5314B41	K5314B40				K5314B42U	K5314B41U	K5314B40U
		€ 139,90	€ 186,00	€ 219,50				€ 173,50	€ 225,40	€ 248,00
	1740x460/3	K5314B45	K5314B44	K5314B43				K5314B45U	K5314B44U	K5314B43U
		€ 237,20	€ 319,70	€ 356,00				€ 302,50	€ 393,30	€ 412,40
	2200x460/3	K5314B48	K5314B47	K5314B46				K5314B48U	K5314B47U	K5314B46U
		€ 309,90	€ 397,70	€ 443,30				€ 412,10	€ 494,80	€ 544,80
2300x620/3	K5314B51	K5314B50	K5314B49				K5314B51A	K5314B50A	K5314B49A	
	€ 446,00	€ 598,00	€ 664,70				€ 542,50	€ 672,70	€ 758,60	
2920x620/3	K5314B54	K5314B53	K5314B52				K5314B54A	K5314B53A	K5314B52A	
	€ 534,80	€ 674,00	€ 753,30				€ 714,50	€ 886,10	€ 996,60	



GESTALTUNGSREGELN FÜR HINWEISSCHILDER AUTOBAHN gemäß RVS 05.02.13

Schrifthöhen und Tafelformate (Auszug aus der RVS 05.02.13):

Die Schrifthöhe der Wegweisung ist der u.a. Tabelle zu entnehmen:





Die Tafelgrößen sind entsprechend der Anzahl und der Länge der Zielangaben in Abhängigkeit von der zu verwendenden Mindestschrifthöhe zu wählen.

Mindestschrifthöhen		
seitliche Wegweiser:		
Tafel bzw. Zielart	Schrifthöhe	
Entfernungsangaben, Ziele auf Orientierungs- und Entfernungstafeln Nr. bei Exit-Tafel	250 mm	
Anschlussstelle bei Orientierungstafel und Ausfahrtswegweisern, überrächste Anschlussstelle Wegweiser auf Rampen	320 mm	
Fernziel und Anschlussstelle bei Vorwegweiser, Knotenankündigung Ziele in Farbeinsätzen	400 mm	
Ziele in Farbeinsätzen	6 E	
Überkopfwegweiser:		
Tafel bzw. Zielart	> 80 km/h	≤ 80 km/h
Fern- und Bereichsziele	500 mm	400 mm
Nächste Anschlussstelle	400 mm	320 mm
Ziele in Farbeinsätzen	6 E	6 E
Entfernungsangabe	300 mm	250 mm

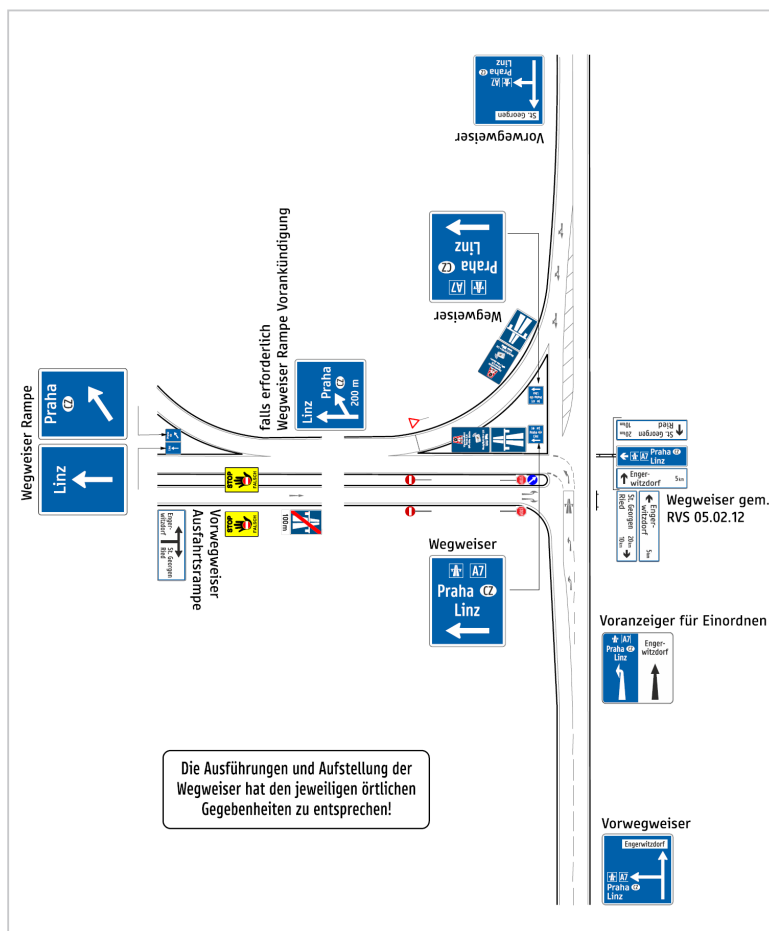

BESCHILDERUNGSREGELN FÜR HINWEISSCHILDER AUTOBAHN gemäß RVS 05.02.13

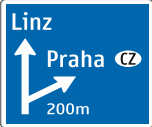
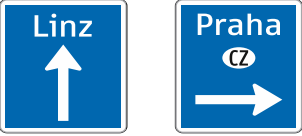

HINWEISZEICHEN § 53	MASSE/ STÄRKE MM	AUSFÜHRUNG ALFORM		
		Folie EGP	Folie HIP	Folie DGV
		Type 1	Type 2	Type 3
§ 53/14a Vorwegweiser 	1000x1500/3		K53AB02A € 565,40	K53AB01A € 647,40
	1500x1500/3		K53AB05A € 1.146,70	K53AB04A € 1.228,10
	1500x2000/3		K53AB08A € 1.593,40	K53AB07A € 1.788,80
	1500x2500/3		K53AB11A € 1.934,10	K53AB10A € 2.128,60
	2000x2000/3		K53AB14A € 2.032,60	K53AB13A € 2.237,00
	2000x2500/3		K53AB17A € 2.544,20	K53AB16A € 2.799,80
	2500x1500/3		K53AB20A € 1.946,00	K53AB19A € 2.194,20
	2500x2000/3		K53AB23A € 2.655,10	K53AB22A € 2.991,20
	2500x2500/3		K53AB26A € 3.189,20	K53AB25A € 3.598,50
	2500x3000/3		K53AB29A € 3.862,60	K53AB28A € 4.356,70
§ 53/15a_a Wegweiser 	2500x3500/3		K53AB32A € 4.586,20	K53AB31A € 5.169,30
	2500x4000/3		K53AB35A € 5.134,70	K53AB34A € 5.792,20
	3000x1500/3		K53AB38A € 2.310,50	K53AB37A € 2.606,40
	3000x2000/3		K53AB41A € 3.158,00	K53AB40A € 3.559,00
	3000x2500/3		K53AB44A € 3.789,60	K53AB43A € 4.277,60
	3000x3000/3		K53AB47A € 4.611,90	K53AB46A € 5.202,90
	3000x3500/3		K53AB50A € 5.433,40	K53AB49A € 6.127,20
	3000x4000/3		K53AB53A € 6.105,40	K53AB52A € 6.889,70
	3500x2000/3		K53AB56A € 3.778,00	K53AB55A € 4.253,50
	3500x2500/3		K53AB59A € 4.576,70	K53AB58A € 5.159,00
§ 53 Wegweiser Rampe Vorankündigung 	3500x3000/3		K53AB62A € 5.531,30	K53AB61A € 6.233,40
	3500x3500/3		K53AB65A € 6.497,00	K53AB64A € 7.319,70
	3500x4000/3		K53AB68A € 7.310,20	K53AB67A € 8.240,80
	3500x4500/3		K53AB71A € 8.253,10	K53AB70A € 9.302,50
	3500x5000/3		K53AB74A € 9.242,20	K53AB73A € 10.414,20
	4000x3000/3		K53AB77A € 6.254,50	K53AB76A € 7.051,30
	4000x3500/3		K53AB80A € 7.384,80	K53AB79A € 8.321,60
	4000x4000/3		K53AB83A € 8.281,00	K53AB82A € 9.338,40
	4000x4500/3		K53AB86A € 9.358,40	K53AB85A € 10.551,50
	4000x5000/3		K53AB89A € 10.488,60	K53AB88A € 11.821,80
§ 53 Wegweiser Rampe 				
§ 53 Vorwegweiser Ausfahrtsrampe 				
§ 53 Vorwegweiser Ausfahrtsrampe touristische Ziele 				



Regelplan:
Anschlussstelle, RFB mit 2 Fahrstreifen

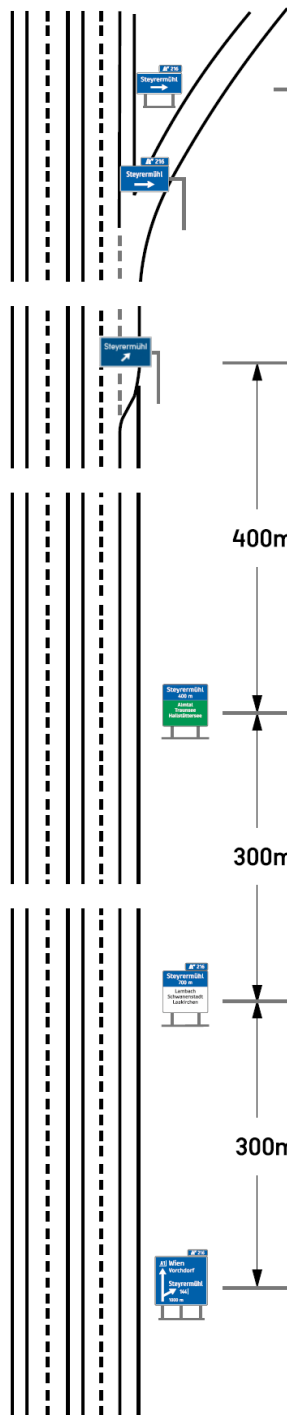

216
Steyrermühl
→
seitliche Ausführung

216
Steyrermühl
→
Überkopfausführung

216
Steyrermühl
↗
Überkopfausführung

1. Ausfahrtswegweiser

400m

216
Steyrermühl
400 m
Almtal
Traunsee
Hallstättersee

Orientierungstafel
Touristische Ziele

300m

216
Steyrermühl
700 m
Lambach
Schwanenstadt
Laakirchen

Orientierungstafel

300m

216
A1 Wien
Vorchdorf
Steyrermühl
144
1000 m

Vorwegweiser
Anschlussstelle

HINWEISZEICHEN § 53		MASSE/ STÄRKE MM	AUSFÜHRUNG ALFORM			
			Folie EOP Type 1	Folie HIP Type 2	Folie DGV Type 3	
§ 53/15a_a Vorwegweiser Anschlussstelle seitliche Ausführung	 A10 Salzburg Hallein Golting 159 162 1200 m Raststation 300 m	2500x1500/3		K53AB20A € 1.946,00	K53AB19A € 2.194,20	
		2500x2500/3		K53AB26A € 3.189,20	K53AB25A € 3.598,50	
	 A1 Wien Vorchdorf Steyrmühl 144 1000 m	2500x3000/3		K53AB29A € 3.862,60	K53AB28A € 4.356,70	
		2500x3500/3		K53AB32A € 4.586,20	K53AB31A € 5.169,30	
	§ 53/15a_b Orientierungstafel seitliche Ausführung	 A1 216 Steyrmühl 700 m Lambach Schwänenstadt Laakirchen	2500x4000/3		K53AB35A € 5.134,70	K53AB34A € 5.792,20
			3000x1500/3		K53AB38A € 2.310,50	K53AB37A € 2.606,40
		3000x2500/3		K53AB44A € 3.789,60	K53AB43A € 4.277,60	
		3000x3000/3		K53AB47A € 4.611,90	K53AB46A € 5.202,90	
		3000x3500/3		K53AB50A € 5.433,40	K53AB49A € 6.127,20	
		3000x4000/3		K53AB53A € 6.105,40	K53AB52A € 6.889,70	
		3500x2000/3		K53AB56A € 3.778,00	K53AB55A € 4.253,50	
		3500x2500/3		K53AB59A € 4.576,70	K53AB58A € 5.159,00	
§ 53/15a_c Orientierungstafel touristische Ziele seitliche Ausführung		 A1 216 Steyrmühl 400 m Almtal Traunsee Hallstättersee	3500x3000/3		K53AB62A € 5.531,30	K53AB61A € 6.233,40
			4000x2000/3		K53AB92A € 4.280,90	K53AB91A € 4.821,30
§ 53/15b_a 1. Ausfahrtswegweiser Anschlussstelle Überkopfausführung Kragarm	 A1 216 Steyrmühl	4000x2500/3		K53AB95A € 5.177,10	K53AB94A € 5.838,10	
		4000x3000/3		K53AB77A € 6.254,50	K53AB76A € 7.051,30	
		4000x4500/3		K53AB86A € 9.358,40	K53AB85A € 10.551,50	
		4000x5000/3		K53AB89A € 10.488,60	K53AB88A € 11.821,80	
§ 53/15b_b 2. Ausfahrtswegweiser Anschlussstelle	a) seitliche Ausführung A1 216 Steyrmühl	b) Überkopfausführung Kragarm A1 216 Steyrmühl	Überkopfwegweiser:			
			Höhe: 2000		K53UEK01A € 1.311,80	
			Höhe: 2500		K53UEK04A € 1.657,60	
			Höhe: 3000		K53UEK07A € 2.007,80	
			Höhe: 3500		K53UEK10A € 2.372,70	
			Preise per lfm.			
§ 53 Exit-Tafel	 A1 216	1500x500/3		K539968A € 417,30	K539967A € 469,90	
		2000x600/3			K539970A € 701,80	
§ 53 Umleitungsbeschilderung	 U 29	1500x500/3		K53ABU02A € 417,30	K53ABU01A € 469,90	
		2000x600/3			K53ABU04A € 701,80	





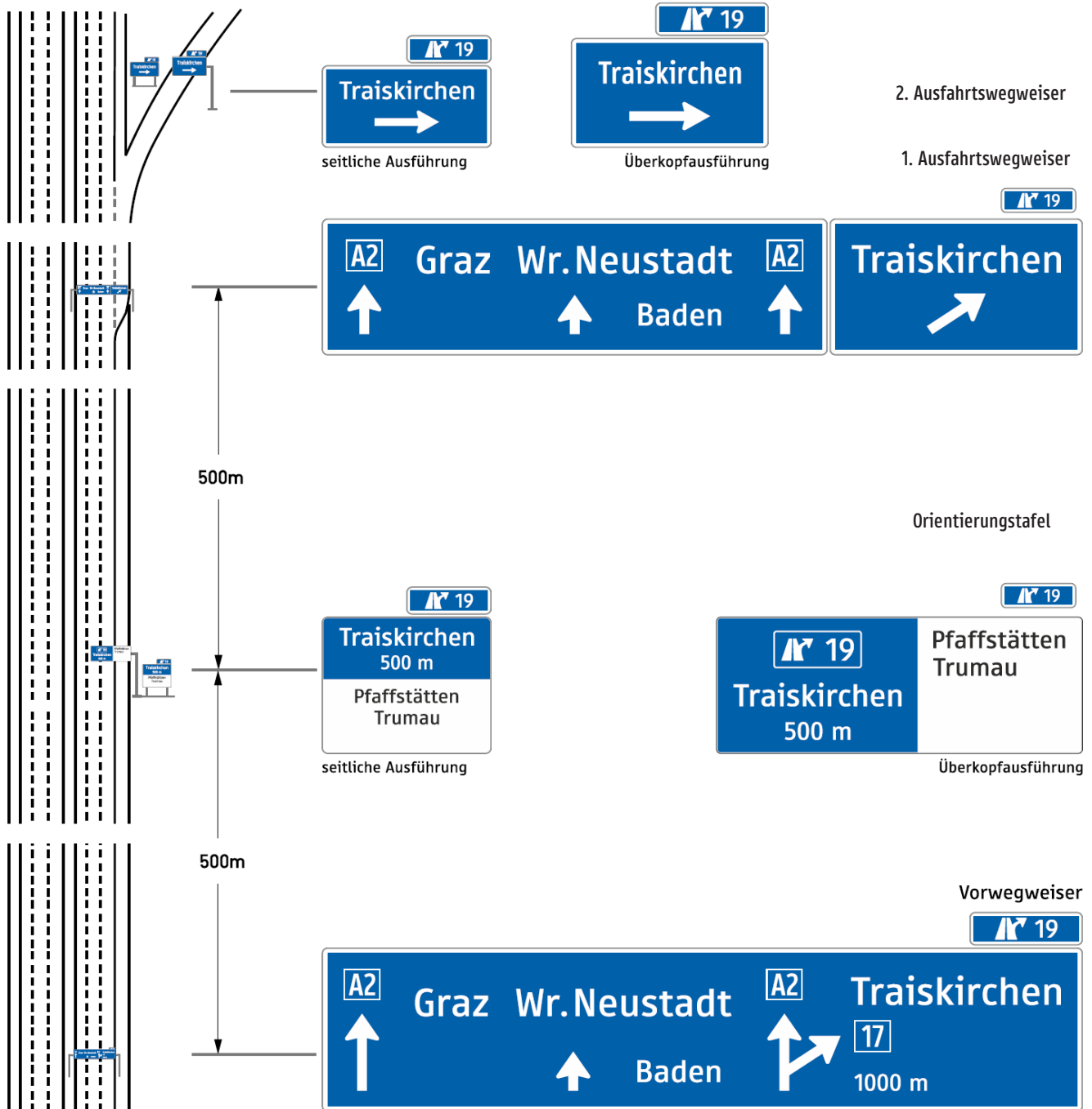

Regelplan
Anschlussstelle, RFB mit 3 Fahrstreifen

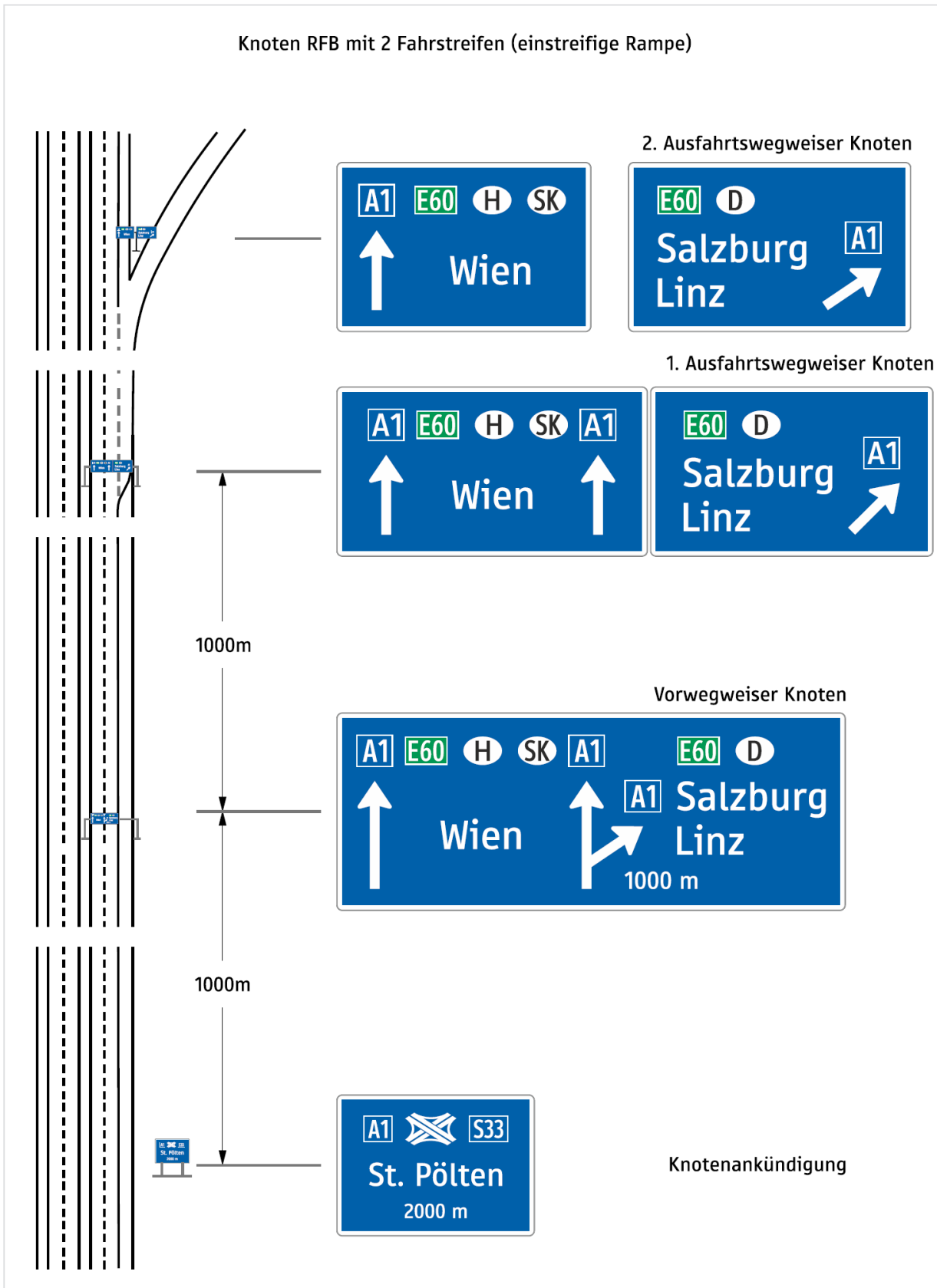

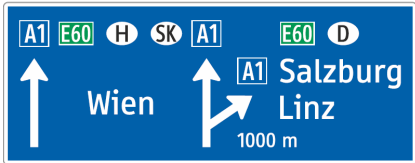
Knoten RFB mit 2 Fahrstreifen (einstreifige Rampe)



HINWEISZEICHEN § 53		MASSE/ STÄRKE MM	AUSFÜHRUNG ALFORM		
			Folie EBP Type 1	Folie HIP Type 2	Folie DGV Type 3
§ 53 Knotenankündigung seitliche Ausführung		2500x2500/3		K53AB26A € 3.189,20	K53AB25A € 3.598,50
		3000x2500/3		K53AB44A € 3.789,60	K53AB43A € 4.277,60
		3500x2500/3		K53AB59A € 4.576,70	K53AB58A € 5.159,00
§ 53 Vorwegweiser Knoten Überkopfausführung		Überkopfwegweiser:			
		Höhe: 2000			K53UEK01A € 1.311,80
		Höhe: 2500			K53UEK04A € 1.657,60
		Höhe: 3000			K53UEK07A € 2.007,80
		Höhe: 3500			K53UEK10A € 2.372,70
			Preise per lfm.		
§ 53 1. Ausfahrtswegweiser Knoten Überkopfausführung					
§ 53 2. Ausfahrtswegweiser Knoten Überkopfausführung Kragarm					
§ 53 Exit-Tafel		1500x500/3		K539968A € 417,30	K539967A € 469,90
		2000x600/3			K539970A € 701,80
§ 53 Umleitungsbeschilderung		1500x500/3		K53ABU02A € 417,30	K53ABU01A € 469,90
		2000x600/3			K53ABU04A € 701,80



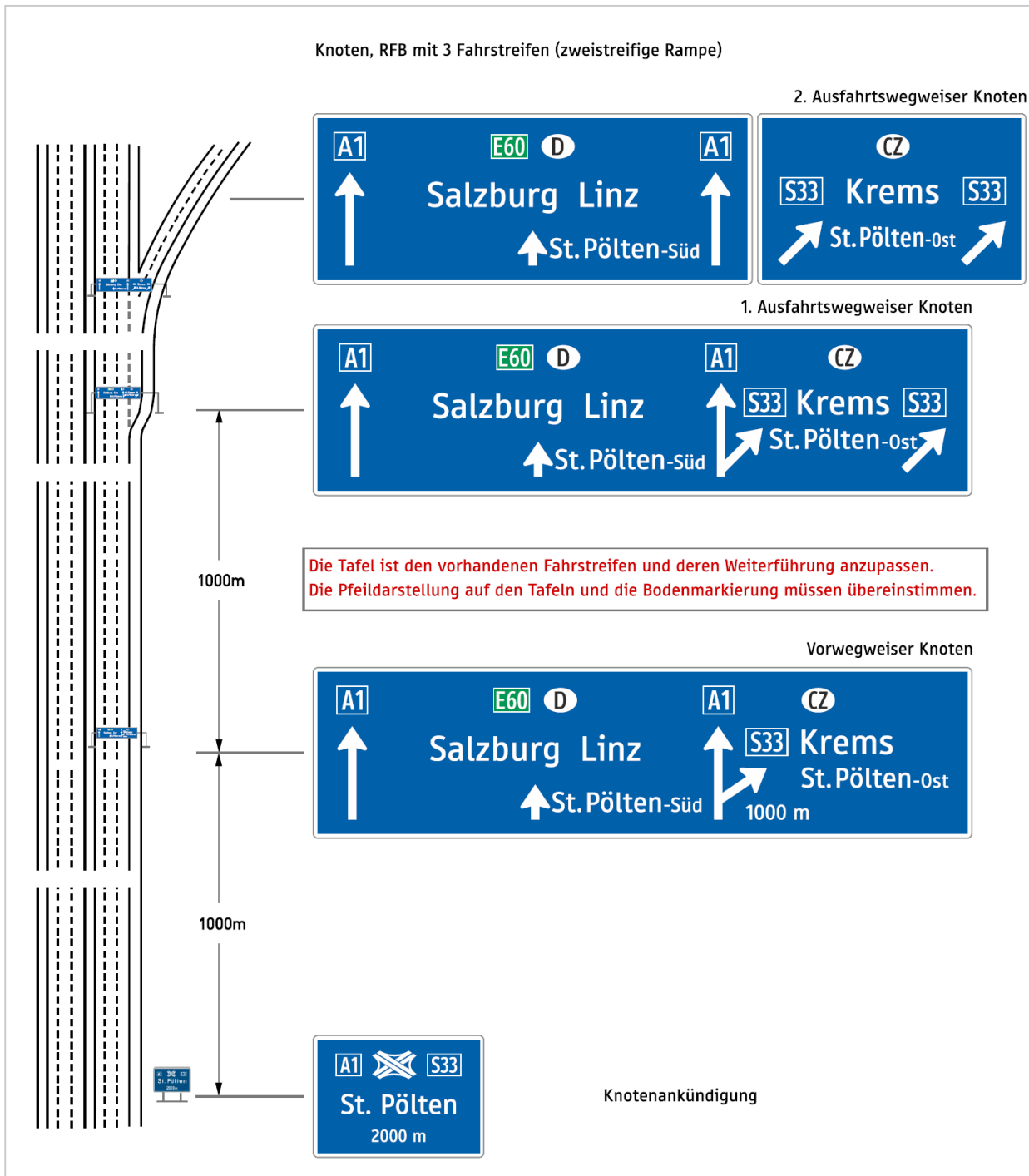

HINWEISZEICHEN § 53

MASSE/ STÄRKE MM	AUSFÜHRUNG ALFORM		
	Folie EGP Type 1	Folie HIP Type 2	Folie DGV Type 3
2500x2500/3		K53AB26A € 3.189,20	K53AB25A € 3.598,50
3000x2500/3		K53AB44A € 3.789,60	K53AB43A € 4.277,60
3500x2500/3		K53AB59A € 4.576,70	K53AB58A € 5.159,00

§ 53
Knotenankündigung
seitliche Ausführung



§ 53
Vorwegweiser Knoten mit Fahrstreifensubtraktion
Überkopfausführung



§ 53
1. Ausfahrtswegweiser Knoten
Überkopfausführung



§ 53
2. Ausfahrtswegweiser Knoten
Überkopfausführung



Überkopfwegweiser:		
Höhe:		K53UEK01A
2000		€ 1.311,80
Höhe:		K53UEK04A
2500		€ 1.657,60
Höhe:		K53UEK07A
3000		€ 2.007,80
Höhe:		K53UEK10A
3500		€ 2.372,70
Preise per lfm.		

§ 53
Exit-Tafel
seitliche Ausführung: 1500x500/3
Überkopfausführung: 2000x600/3



1500x500/3	K539968A € 417,30	K539967A € 469,90
2000x600/3		K539970A € 701,80

§ 53
Umleitungsbeschilderung
seitliche Ausführung: 1500x500/3
Überkopfausführung: 2000x600/3



1500x500/3	K53ABU02A € 417,30	K53ABU01A € 469,90
2000x600/3		K53ABU04A € 701,80

Knoten, RFB mit 3 Fahrstreifen Fahrstreifensubtraktion (zweistreifige Rampe)

2. Ausfahrtswegweiser Knoten

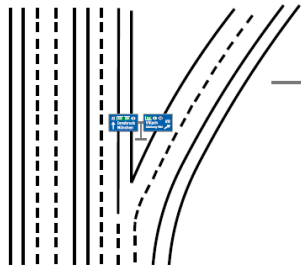

1. Ausfahrtswegweiser Knoten

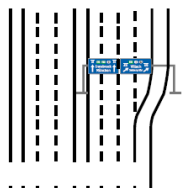

1000m



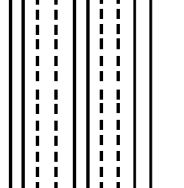

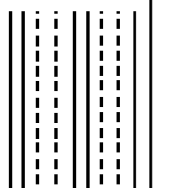

Vorwegweiser Knoten mit Fahrstreifensubtraktion



1000m



Knotenankündigung

HINWEISZEICHEN § 53		MASSE/ STÄRKE MM	AUSFÜHRUNG ALFORM		
			Folie EGP Type 1	Folie HIP Type 2	Folie DBV Type 3
§ 53 Knotenankündigung seitliche Ausführung		2500x2500/3		K53AB26A € 3.189,20	K53AB25A € 3.598,50
		3000x2500/3		K53AB44A € 3.789,60	K53AB43A € 4.277,60
		3500x2500/3		K53AB59A € 4.576,70	K53AB58A € 5.159,00
Überkopfwegweiser:					
§ 53 Vorwegweiser Knoten mit Fahrstreifensubtraktion Überkopfausführung		Höhe: 2000		K53UEK01A € 1.311,80	
		Höhe: 2500		K53UEK04A € 1.657,60	
		Höhe: 3000		K53UEK07A € 2.007,80	
		Höhe: 3500		K53UEK10A € 2.372,70	
Preise per lfm.					
§ 53 1. Ausfahrtswegweiser Knoten Überkopfausführung					
§ 53 2. Ausfahrtswegweiser Knoten Überkopfausführung Kragarm					
§ 53 Exit-Tafel		seitliche Ausführung: 1500x500/3	1500x500/3	K539968A € 417,30	K539967A € 469,90
		Überkopfausführung: 2000x600/3	2000x600/3		K539970A € 701,80
§ 53 Umleitungsbeschilderung		seitliche Ausführung: 1500x500/3	1500x500/3	K53ABU02A € 417,30	K53ABU01A € 469,90
		Überkopfausführung: 2000x600/3	2000x600/3		K53ABU04A € 701,80



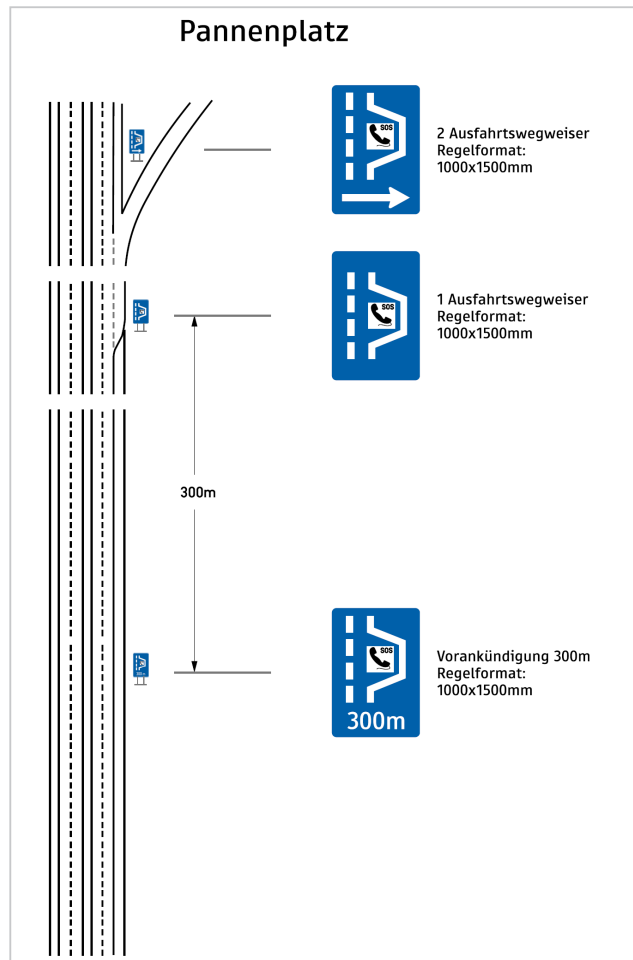
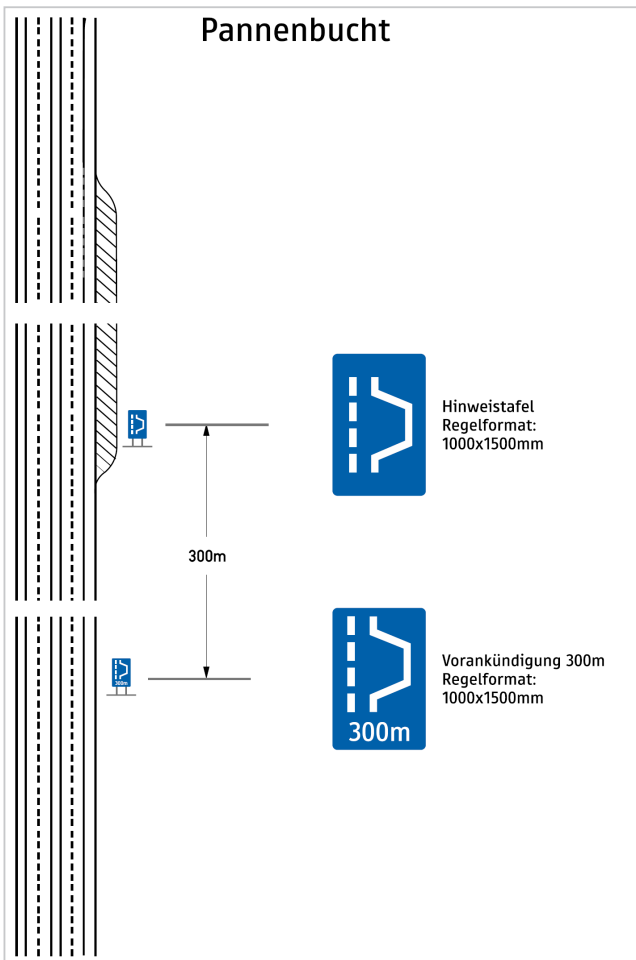

HINWEISZEICHEN § 53	MASSE/ STÄRKE MM	AUSFÜHRUNG FLACH			AUSFÜHRUNG FORMLINE			AUSFÜHRUNG ALFORM		
		Folie EGP Type 1	Folie HIP Type 2	Folie DGV Type 3	Folie EGP Type 1	Folie HIP Type 2	Folie DGV Type 3	Folie EGP Type 1	Folie HIP Type 2	Folie DGV Type 3
		Pannenbucht §53 								
	1000x1500/3		K539947 € 519,80	K539946 € 597,30					K539947U € 565,40	K539946U € 647,40
Pannenplatz §53 										
	1000x1500/3		K539950 € 519,80	K539949 € 597,30					K539950U € 565,40	K539949U € 647,40

HINWEISZEICHEN
§ 53

BESCHILDERUNG VON PARKPLÄTZEN

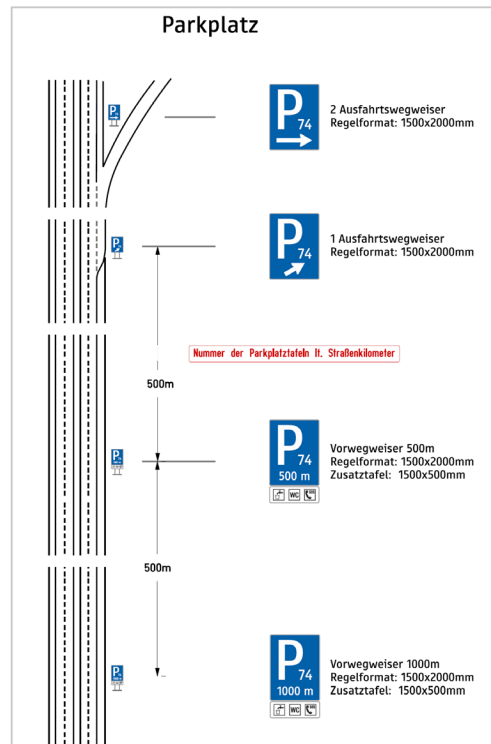

HINWEISZEICHEN § 53	MASSE/ STÄRKE MM	AUSFÜHRUNG FLACH			AUSFÜHRUNG FORMLINE			AUSFÜHRUNG ALFORM		
		Folie EGP Type 1	Folie HIP Type 2	Folie DGV Type 3	Folie EGP Type 1	Folie HIP Type 2	Folie DGV Type 3	Folie EGP Type 1	Folie HIP Type 2	Folie DGV Type 3
Vorwegweiser 1000m §53 *ohne Zusatztafel	1500x2000/3								K53999002U € 1.593,40	K53999001U € 1.788,80
Vorwegweiser 500m §53 *ohne Zusatztafel										
1. Ausfahrtswegweiser §53 										
2. Ausfahrtswegweiser §53 										
Zusatztafel §53 	1500x500/3								K53999014U € 417,30	K53999013U € 469,90



Rastplatz

2. Ausfahrtswegweiser



1. Ausfahrtswegweiser



seitliche Ausführung

Überkopfausführung

1000m

Vorwegweiser 1000m



6-22 LOGO Betreiber

1000m

Vorwegweiser 2000m











6-22 LOGO Betreiber

3000m

Vorwegweiser 5km



HINWEISZEICHEN § 53	MASSE/ STÄRKE MM	AUSFÜHRUNG ALFORM		
		Folie EGP Type 1	Folie HIP Type 2	Folie DGV Type 3
§ 53 Vorwegweiser 5 km seitliche Ausführung 	3000x2000/3		K53AB41A € 3.158,00	K53AB40A € 3.559,00
	3000x2500/3		K53AB44A € 3.789,60	K53AB43A € 4.277,60
	3000x3000/3		K53AB47A € 4.611,90	K53AB46A € 5.202,90
	5000x2000/3		K53AB99A € 5.286,80	K53AB100A € 5.956,90
§ 53 Vorwegweiser 2000m seitliche Ausführung  6-22 LOGO Betreiber				
§ 53 Vorwegweiser 1000m seitliche Ausführung  6-22 LOGO Betreiber				
§ 53 1. Ausfahrtswegweiser a) seitliche Ausführung  b) Überkopfausführung Kragarm 				
§ 53 2. Ausfahrtswegweiser seitliche Ausführung 				
§ 53 Zusatztafel  	3000x700/3		K5315PZ02A € 1.148,60	K5315PZ01A € 1.286,30



Raststation

2. Ausfahrtswegweiser

1. Ausfahrtswegweiser

Überkopfausführung







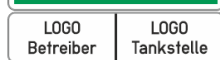
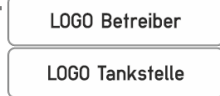
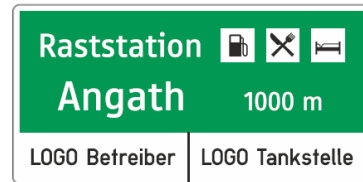
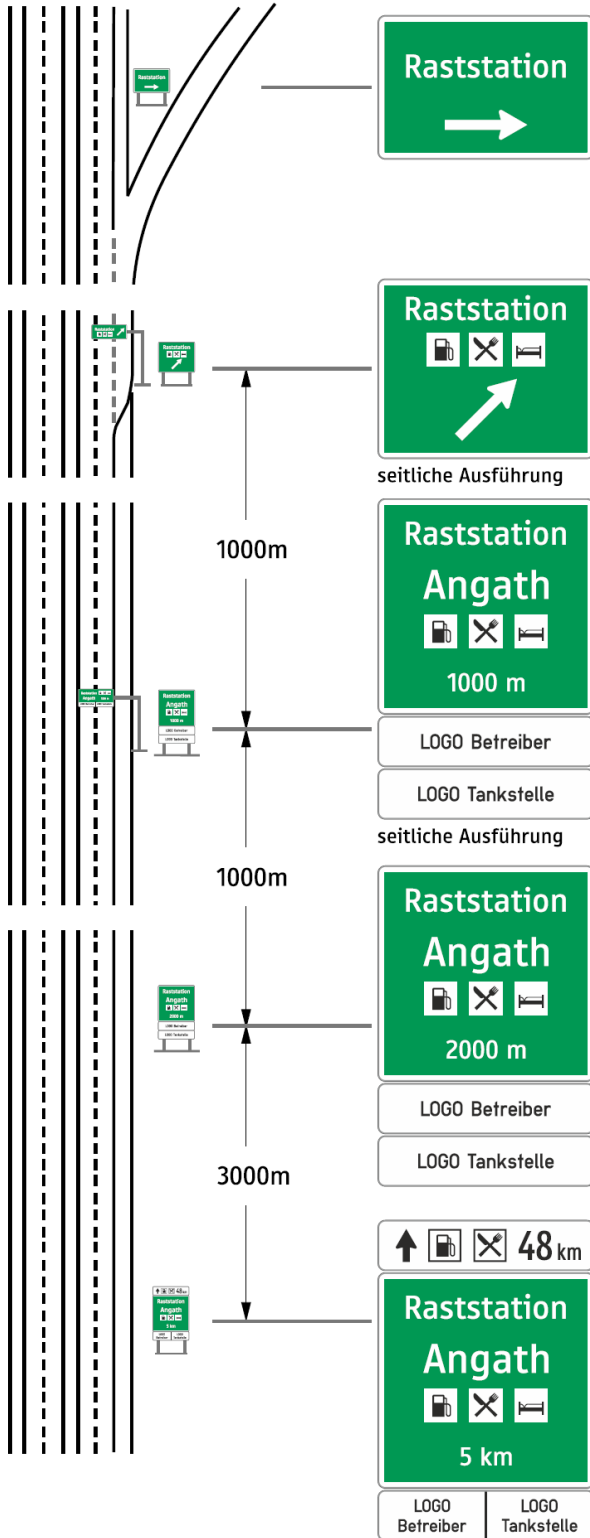

Vorwegweiser 1000m

Überkopfausführung

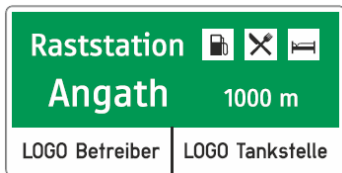
Vorwegweiser 2000m





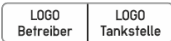



Ankündigungstafel 5km











HINWEISZEICHEN § 53	MASSE/ STÄRKE MM	AUSFÜHRUNG ALFORM		
		Folie EGP Type 1	Folie HIP Type 2	Folie DGV Type 3
§ 53 Ankündigungstafel 5 km seitliche Ausführung 	3000x2000/3		K53AB41A € 3.158,00	K53AB40A € 3.559,00
	3000x2500/3		K53AB44A € 3.789,60	K53AB43A € 4.277,60
	3000x3000/3		K53AB47A € 4.611,90	K53AB46A € 5.202,90
	5000x2000/3		K53AB99A € 5.286,80	K53AB100A € 5.956,90
	5000x2500/3		K53AB102A € 6.392,30	K53AB103A € 7.212,00
§ 53 Vorwegweiser 2000m seitliche Ausführung 				
§ 53 Vorwegweiser 1000m a) seitliche Ausführung 				
	b) Überkopfausführung Kragarm 			
§ 53 1. Ausfahrtswegweiser a) seitliche Ausführung 				
	b) Überkopfausführung Kragarm 			
§ 53 2. Ausfahrtswegweiser seitliche Ausführung 				
§ 53 Zusatztafel 	3000x700/3		K5315RZ02A € 1.148,60	K5315RZ01A € 1.286,30
				
				







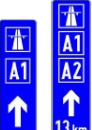



VERKEHRSZEICHEN









HINWEISZEICHEN § 53	MASSE/ STÄRKE MM	AUSFÜHRUNG FLACH			AUSFÜHRUNG FORMLINE			AUSFÜHRUNG ALFORM			
		Folie EGP	Folie HIP	Folie DGV	Folie EGP	Folie HIP	Folie DGV	Folie EGP	Folie HIP	Folie DGV	
		Type 1	Type 2	Type 3	Type 1	Type 2	Type 3	Type 1	Type 2	Type 3	
Entfernungstafeln - Anschlussstelle/Knoten § 53/15c  	2500x2000/3								K53AB110A € 2.655,10	K53AB109A € 2.991,20	
	2500x2500/3								K53AB113A € 3.189,20	K53AB112A € 3.598,50	
	2500x3000/3								K53AB116A € 3.862,60	K53AB115A € 4.356,70	
	2500x3500/3								K53AB119A € 4.586,20	K53AB118A € 5.169,30	
	3000x2000/3								K53AB122A € 3.158,00	K53AB121A € 3.559,00	
	3000x2500/3								K53AB125A € 3.789,60	K53AB124A € 4.277,60	
	3000x3000/3								K53AB128A € 4.611,90	K53AB127A € 5.202,90	
	3000x3500/3								K53AB131A € 5.433,40	K53AB130A € 6.127,20	
	Ankündigung von kulturell bedeutenden Sehenswürdigkeiten § 53  	Einzeltafel:									
		2500x2500/3								K5399K02A € 3.189,20	K5399K01A € 3.598,50
2500x3500/3									K5399K05A € 4.586,20	K5399K04A € 5.169,30	
Doppeltafel:											
2500x3500/3									K5399K08A € 4.586,20	K5399K07A € 5.169,30	
2500x4000/3									K5399K16A € 5.134,70	K5399K15A € 5.792,20	
4000x2500/3									K5399K18A € 5.177,10	K5399K17A € 5.838,10	
Ankündigung von touristisch bedeutenden Sehenswürdigkeiten § 53  		Einzeltafel:									
		2500x2500/3								K5399T02A € 3.189,20	K5399T01A € 3.598,50
		2500x3500/3								K5399T05A € 4.586,20	K5399T04A € 5.169,30
	Doppeltafel:										
	2500x4000/3								K5399T16A € 5.134,70	K5399T15A € 5.792,20	
	4000x2500/3								K5399T18A € 5.177,10	K5399T17A € 5.838,10	
Nebelwarntafel auf Autobahnen und Autostraßen § 53   	2500x3500/3								K5399I17A € 4.586,20	K5399I16A € 5.169,30	
	1500x3500/3								K5399G5A € 2.647,10	K5399G4A € 2.915,70	

HINWEISZEICHEN § 53	MASSE/ STÄRKE MM	AUSFÜHRUNG FLACH			AUSFÜHRUNG FORMLINE			AUSFÜHRUNG ALFORM		
		Folie EGP Type 1	Folie HIP Type 2	Folie DGV Type 3	Folie EGP Type 1	Folie HIP Type 2	Folie DGV Type 3	Folie EGP Type 1	Folie HIP Type 2	Folie DGV Type 3
Mautinfotafel §53 	630x960/2,5		K5399VI02 € 205,30	K5399VI01 € 236,30		K5399VI02F € 263,50	K5399VI01F € 280,80		K5399VI02U € 243,30	K5399VI01U € 270,70
	960x1200/3		K5399VI05 € 342,40	K5399VI04 € 432,50					K5399VI05U € 425,10	K5399VI04U € 501,00
	1000x1500/3		K5399VI08 € 519,80	K5399VI07 € 597,30					K5399VI08U € 565,40	K5399VI07U € 647,40
Geisterfahrerwarntafel (neongelbe Ausf.) §53 	1500x2000/3									K5399G01A € 1.772,80
Videüberwachung §53 	630x960/2,5		K5399V02 € 205,30	K5399V01 € 236,30		K5399V02F € 263,50	K5399V01F € 280,80		K5399V02U € 243,30	K5399V01U € 270,70
	1000x1500/3		K5399V05 € 519,80	K5399V04 € 597,30					K5399V05U € 565,40	K5399V04U € 647,40
	1500x2000/3								K5399V08A € 1.593,40	K5399V07A € 1.788,80
Section Control §53 	630x960/2,5		K5399S02 € 205,30	K5399S01 € 236,30		K5399S02F € 263,50	K5399S01F € 280,80		K5399S02U € 243,30	K5399S01U € 270,70
	1000x1500/3		K5399S05 € 519,80	K5399S04 € 597,30					K5399S05U € 565,40	K5399S04U € 647,40
	1500x2000/3								K5399S08A € 1.593,40	K5399S07A € 1.788,80
Sondertafel Allgemeine Geschwindigkeitsbeschränkung §53 	1000x1200/3		S532202 € 519,80	S532201 € 597,30					S532202U € 565,40	S532201U € 647,40
Kilometertafel für Autobahnen (alle 10 km) §53 	470x630/2		KRVS231 € 102,10	KRVS230 € 114,50		KRVS231F € 119,30	KRVS230F € 141,20		KRVS231U € 128,90	KRVS230U € 143,10
Kilometertafel für Autobahnen (alle km) §53 	470x200/2		KRVS234 € 53,10	KRVS233 € 61,60					KRVS234U € 79,90	KRVS233U € 87,30
Kilometertafeln für Rampen Ausführung A §53 	230x470/2		KRVS255 € 53,50	KRVS254 € 59,00		KRVS255F € 84,20	KRVS254F € 85,80		KRVS255U € 87,90	KRVS254U € 89,80
Kilometertafeln für Rampen Ausführung B §53 	310x170/2		KRVS258 € 42,30	KRVS257 € 47,50					KRVS258U € 75,20	KRVS257U € 76,20
	470x200/2		KRVS261 € 53,10	KRVS260 € 61,60					KRVS261U € 79,90	KRVS260U € 87,30
Hinweise zur Autobahn §53 	310x960/2		KRVS288 € 91,10	KRVS287 € 126,30		KRVS288F € 110,70	KRVS287F € 142,80		KRVS288U € 123,00	KRVS287U € 159,90
	310x1150/2		KRVS291 € 140,40	KRVS290 € 159,90		KRVS291F € 168,10	KRVS290F € 186,50		KRVS291U € 184,60	KRVS290U € 202,80
	460x1460/2		KRVS2288 € 261,10	KRVS2287 € 280,30					KRVS2288U € 307,20	KRVS2287U € 323,20
	460x1740/3		KRVS2291 € 312,30	KRVS2290 € 348,10					KRVS2291U € 344,20	KRVS2290U € 391,80









VERKEHRSZEICHEN





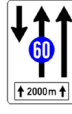

HINWEISZEICHEN § 53	MASSE/ STÄRKE MM	AUSFÜHRUNG FLACH			AUSFÜHRUNG FORMLINE			AUSFÜHRUNG ALFORM		
		Folie EGP	Folie HIP	Folie DGV	Folie EGP	Folie HIP	Folie DGV	Folie EGP	Folie HIP	Folie DGV
		Type 1	Type 2	Type 3	Type 1	Type 2	Type 3	Type 1	Type 2	Type 3
Ortsstafel §53/17a 	960x630/2,5	K5317A03 € 162,80	K5317A02 € 205,30	K5317A01 € 236,30	K5317A03F € 192,90	K5317A02F € 263,50	K5317A01F € 280,80	K5317A03U € 194,40	K5317A02U € 243,30	K5317A01U € 270,70
	1500x1000/3	K5317A06 € 378,90	K5317A05 € 519,80	K5317A04 € 597,30				K5317A06U € 432,30	K5317A05U € 565,40	K5317A04U € 647,40
	2000x1000/3	K5317A09 € 488,10	K5317A08 € 691,50	K5317A07 € 813,80				K5317A09U € 513,50	K5317A08U € 681,10	K5317A07U € 786,20
Ortsende §53/17b 	960x630/2,5	K5317B03 € 162,80	K5317B02 € 205,30	K5317B01 € 236,30	K5317B03F € 192,90	K5317B02F € 263,50	K5317B01F € 280,80	K5317B03U € 194,40	K5317B02U € 243,30	K5317B01U € 270,70
	1500x1000/3	K5317B06 € 378,90	K5317B05 € 519,80	K5317B04 € 597,30				K5317B06U € 432,30	K5317B05U € 565,40	K5317B04U € 647,40
	2000x1000/3	K5317B09 € 488,10	K5317B08 € 691,50	K5317B07 € 813,80				K5317B09U € 513,50	K5317B08U € 681,10	K5317B07U € 786,20
Ortsbezeichnungstafel Zusatztafel mit Entfernungsangabe bis zum nächsten Ort. Anbringung unter der Ortstafel §53 	960x310/2	K539990 € 64,90	K539989 € 91,10	K539988 € 126,30	K539990F € 101,90	K539989F € 110,70	K539988F € 142,80	K539990U € 98,80	K539989U € 123,00	K539988U € 159,90
	1500x310/2,5	K539993 € 134,50	K539992 € 177,10	K539991 € 188,20				K539993U € 204,30	K539992U € 241,90	K539991U € 265,70
	2000x310/2,5	K539996 € 178,70	K539995 € 234,70	K539994 € 255,30				K539996U € 227,00	K539995U € 296,80	K539994U € 353,80
Ortsbezeichnungstafeln §53 	630x310/2	KRVS214 € 42,90	KRVS213 € 49,70	KRVS212 € 52,40	KRVS214F € 79,00	KRVS213F € 97,60	KRVS212F € 109,00	KRVS214U € 76,20	KRVS213U € 82,90	KRVS212U € 85,60
	960x310/2	KRVS211 € 64,90	KRVS210 € 91,10	KRVS209 € 126,30	KRVS211F € 101,90	KRVS210F € 110,70	KRVS209F € 142,80	KRVS211U € 98,80	KRVS210U € 123,00	KRVS209U € 159,90
Ankündigung für Erholungsorte §53 	960x310/2	KRVS217 € 64,90	KRVS216 € 91,10	KRVS215 € 126,30	KRVS217F € 101,90	KRVS216F € 110,70	KRVS215F € 142,80	KRVS217U € 98,80	KRVS216U € 123,00	KRVS215U € 159,90
	1500x310/2,5	KRVS220 € 134,50	KRVS219 € 177,10	KRVS218 € 188,20				KRVS220U € 204,30	KRVS219U € 241,90	KRVS218U € 265,70
Internationaler Hauptverkehrsveg §53/18 	470x310/2	K531803 € 47,60	K531802 € 59,60	K531801 € 68,20	K531803F € 73,40	K531802F € 77,80	K531801F € 79,50	K531803U € 74,90	K531802U € 96,40	K531801U € 99,10
	630x470/2	K531806 € 85,80	K531805 € 102,10	K531804 € 114,50	K531806F € 110,50	K531805F € 119,30	K531804F € 141,20	K531806U € 107,90	K531805U € 128,90	K531804U € 143,10
	960x630/2,5	K531809 € 162,80	K531808 € 205,30	K531807 € 236,30	K531809F € 192,90	K531808F € 263,50	K531807F € 280,80	K531809U € 194,40	K531808U € 243,30	K531807U € 270,70
Bundesstraße mit Vorrang §53/19 a)  	310x310/2	K531903 € 41,00	K531902 € 50,00	K531901 € 56,70	K531903F € 51,30	K531902F € 54,30	K531901F € 55,40	K531903U € 66,90	K531902U € 84,70	K531901U € 86,50
	470x470/2	K531906 € 50,10	K531905 € 70,20	K531904 € 86,70	K531906F € 93,20	K531905F € 100,60	K531904F € 105,80	K531906U € 86,20	K531905U € 106,00	K531904U € 125,50
	630x630/2	K531909 € 84,30	K531908 € 118,80	K531907 € 141,90	K531909F € 173,50	K531908F € 185,30	K531907F € 194,40	K531909U € 120,60	K531908U € 156,80	K531907U € 191,10
Bundesstraße mit Vorrang §53/19 b) 	470x310/2	K531912 € 47,60	K531911 € 59,60	K531910 € 68,20	K531912F € 73,40	K531911F € 77,80	K531910F € 79,50	K531912U € 74,90	K531911U € 96,40	K531910U € 99,10
	630x470/2	K531915 € 85,80	K531914 € 102,10	K531913 € 114,50	K531915F € 110,50	K531914F € 119,30	K531913F € 141,20	K531915U € 107,90	K531914U € 128,90	K531913U € 143,10
	960x630/2,5	K531918 € 162,80	K531917 € 205,30	K531916 € 236,30	K531918F € 192,90	K531917F € 263,50	K531916F € 280,80	K531918U € 194,40	K531917U € 243,30	K531916U € 270,70

HINWEISZEICHEN § 53	MASSE/ STÄRKE MM	AUSFÜHRUNG FLACH			AUSFÜHRUNG FORMLINE			AUSFÜHRUNG ALFORM		
		Folie EGP	Folie HIP	Folie DGV	Folie EGP	Folie HIP	Folie DGV	Folie EGP	Folie HIP	Folie DGV
		Type 1	Type 2	Type 3	Type 1	Type 2	Type 3	Type 1	Type 2	Type 3
Landes- oder Bezirksstraße §53/21 	310x150/2									
		K532103 € 29,70	K532102 € 31,50							
Kilometertafel für Bundesstraßen 	310x170/2									
		KRVS241 € 35,80	KRVS240 € 42,30	KRVS239 € 47,50				KRVS241U € 60,40	KRVS240U € 75,20	KRVS239U € 76,20
Kilometertafel für Bundesstraßen 	310x170/2									
		KRVS250 € 130,20	KRVS249 € 134,30	KRVS248 € 135,90						
aus Alu abgekantet, mit Versteifung, samt verschweißtem Rohr DM 60/2, Länge: 1500 mm, beidseitig mit Folie belegt										
Kilometertafel für Landstraßen einseitig 	100x180/2									
		KRVS253 € 30,50								
Allgemeine Geschwindigkeitsbeschränkung §53/22 	1000x1500/3		K532202 € 519,80	K532201 € 597,30					K532202U € 565,40	K532201U € 647,40
		1500x2500/3							K532205A € 1.934,10	K532204A € 2.128,60
Voranzeiger fürs Einordnen Nr.1 §53/23 	630x960/2,5	K532303 € 162,80	K532302 € 205,30	K532301 € 236,30	K532303F € 192,90	K532302F € 263,50	K532301F € 280,80	K532303U € 194,40	K532302U € 243,30	K532301U € 270,70
		1000x1500/3	K532306 € 378,90	K532305 € 519,80	K532304 € 597,30				K532306U € 432,30	K532305U € 565,40
	1500x2500/3								K532309A € 1.698,90	K532308A € 1.934,10
Bitte mittels Skizze gewünschte Ausführung bekanntgeben!										
Voranzeiger fürs Einordnen Nr.2 §53/23 	630x960/2,5	K532330 € 162,80	K532329 € 205,30	K532328 € 236,30	K532330F € 192,90	K532329F € 263,50	K532328F € 280,80	K532330U € 194,40	K532329U € 243,30	K532328U € 270,70
		1000x1500/3	K532333 € 378,90	K532332 € 519,80	K532331 € 597,30				K532333U € 432,30	K532332U € 565,40
	1500x2500/3								K532335A € 1.698,90	K532334A € 1.934,10
Bitte mittels Skizze gewünschte Ausführung bekanntgeben!										
Voranzeiger fürs Einordnen Nr.3 §53/23 	630x960/2,5	K532321 € 162,80	K532320 € 205,30	K532319 € 236,30	K532321F € 192,90	K532320F € 263,50	K532319F € 280,80	K532321U € 194,40	K532320U € 243,30	K532319U € 270,70
		1000x1500/3	K532324 € 378,90	K532323 € 519,80	K532322 € 597,30				K532324U € 432,30	K532323U € 565,40
	1500x2500/3								K532327A € 1.698,90	K532326A € 1.934,10
Bitte mittels Skizze gewünschte Ausführung bekanntgeben!										

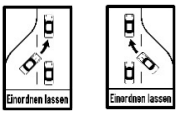







VERKEHRSZEICHEN







HINWEISZEICHEN § 53	MASSE/ STÄRKE MM	AUSFÜHRUNG FLACH			AUSFÜHRUNG FORMLINE			AUSFÜHRUNG ALFORM		
		Folie EGP	Folie HIP	Folie DGV	Folie EGP	Folie HIP	Folie DGV	Folie EGP	Folie HIP	Folie DGV
		Type 1	Type 2	Type 3	Type 1	Type 2	Type 3	Type 1	Type 2	Type 3
Voranzeiger fürs Einordnen Nr.4 §53/23 	960x960/2,5	K532312 € 203,30	K532311 € 293,30	K532310 € 365,20				K532312U € 252,50	K532311U € 353,20	K532310U € 415,50
	1500x1500/3	K532315 € 587,60	K532314 € 758,60	K532313 € 919,90				K532315A € 968,80	K532314A € 1.146,70	K532313A € 1.228,10
	2500x2500/3							K532318A € 2.699,20	K532317A € 3.189,20	K532316A € 3.598,50
Bitte mittels Skizze gewünschte Ausführung bekanntgeben!										
Voranzeiger fürs Einordnen Nr.5 §53/23 	630x960/2,5	K532339 € 162,80	K532338 € 205,30	K532337 € 236,30	K532339F € 192,90	K532338F € 263,50	K532337F € 280,80	K532339U € 194,40	K532338U € 243,30	K532337U € 270,70
	1000x1500/3	K532342 € 378,90	K532341 € 519,80	K532340 € 597,30				K532342U € 432,30	K532341U € 565,40	K532340U € 647,40
	1500x2500/3							K532345A € 1.698,90	K532344A € 1.934,10	K532343A € 2.128,60
Bitte mittels Skizze gewünschte Ausführung bekanntgeben!										
Voranzeiger fürs Einordnen §53/23 	960x960/2,5	K532348 € 203,30	K532347 € 293,30	K532346 € 365,20				K532348U € 252,50	K532347U € 353,20	K532346U € 415,50
	1500x1500/3	K532351 € 587,60	K532350 € 758,60	K532349 € 919,90				K532351A € 968,80	K532350A € 1.146,70	K532349A € 1.228,10
	2500x2500/3							K532354A € 2.699,20	K532353A € 3.189,20	K532352A € 3.598,50
Bitte mittels Skizze gewünschte Ausführung bekanntgeben!										
Voranzeiger fürs Einbiegen §53/23a/1a 	630x960/2,5	K5323A03 € 162,80	K5323A02 € 205,30	K5323A01 € 236,30	K5323A03F € 192,90	K5323A02F € 263,50	K5323A01F € 280,80	K5323A03U € 194,40	K5323A02U € 243,30	K5323A01U € 270,70
	1000x1500/3	K5323A06 € 378,90	K5323A05 € 519,80	K5323A04 € 597,30				K5323A06U € 432,30	K5323A05U € 565,40	K5323A04U € 647,40
	1500x2500/3							K5323A09A € 1.698,90	K5323A08A € 1.934,10	K5323A07A € 2.128,60
Bitte mittels Skizze gewünschte Ausführung bekanntgeben!										
Voranzeiger fürs Einbiegen §53/23a/1b 	630x960/2,5	K5323A03 € 162,80	K5323A02 € 205,30	K5323A01 € 236,30	K5323A03F € 192,90	K5323A02F € 263,50	K5323A01F € 280,80	K5323A03U € 194,40	K5323A02U € 243,30	K5323A01U € 270,70
	1000x1500/3	K5323A06 € 378,90	K5323A05 € 519,80	K5323A04 € 597,30				K5323A06U € 432,30	K5323A05U € 565,40	K5323A04U € 647,40
	1500x2500/3							K5323A09A € 1.698,90	K5323A08A € 1.934,10	K5323A07A € 2.128,60
Bitte mittels Skizze gewünschte Ausführung bekanntgeben!										
Voranzeiger für den Fahrstreifenverlauf - Bundesstraße §53/23b/1a 	1000x1500/3	K5323BA03 € 378,90	K5323BA02 € 519,80	K5323BA01 € 597,30				K5323BA03U € 432,30	K5323BA02U € 565,40	K5323BA01U € 647,40
	1500x2500/3							K5323BA06A € 1.698,90	K5323BA05A € 1.934,10	K5323BA04A € 2.128,60
	2000x2500/3							K5323BA09A € 2.226,40	K5323BA08A € 2.544,20	K5323BA07A € 2.799,80
Bitte mittels Skizze gewünschte Ausführung bekanntgeben!										
Voranzeiger für den Fahrstreifenverlauf - Bundesstraße §53/23b/1b 	1000x1500/3	K5323BB03 € 378,90	K5323BB02 € 519,80	K5323BB01 € 597,30				K5323BB03U € 432,30	K5323BB02U € 565,40	K5323BB01U € 647,40
	1500x2500/3							K5323BB06A € 1.698,90	K5323BB05A € 1.934,10	K5323BB04A € 2.128,60
	2000x2500/3							K5323BB09A € 2.226,40	K5323BB08A € 2.544,20	K5323BB07A € 2.799,80
Bitte mittels Skizze gewünschte Ausführung bekanntgeben!										

HINWEISZEICHEN § 53	MASSE/ STÄRKE MM	AUSFÜHRUNG FLACH			AUSFÜHRUNG FORMLINE			AUSFÜHRUNG ALFORM		
		Folie EGP Type 1	Folie HIP Type 2	Folie DGV Type 3	Folie EGP Type 1	Folie HIP Type 2	Folie DGV Type 3	Folie EGP Type 1	Folie HIP Type 2	Folie DGV Type 3
Voranzeiger für den Fahrstreifenverlauf - Autobahn §53/23b 	2000x2500/3								K5323AB08A € 2.544,20	K5323AB07A € 2.799,80
		Skizze beilegen!								
Fahrstreifenverminderung §53/23c 	1000x1500/3	K5323C03 € 378,90	K5323C02 € 519,80	K5323C01 € 597,30			K5323C03U € 432,30	K5323C02U € 565,40	K5323C01U € 647,40	
	1500x2500/3						K5323C06A € 1.698,90	K5323C05A € 1.934,10	K5323C04A € 2.128,60	
	2000x2500/3						K5323C09A € 2.226,40	K5323C08A € 2.544,20	K5323C07A € 2.799,80	
Straße für Omnibusse § 53/24 	470x470/2	K532403 € 50,10	K532402 € 70,20		K532403F € 93,20	K532402F € 100,60	K532403U € 86,20	K532402U € 106,00		
	630x630/2	K532406 € 84,30	K532405 € 118,80		K532406F € 173,50	K532405F € 185,30	K532406U € 120,60	K532405U € 156,80		
	960x960/2,5	K532409 € 203,30	K532408 € 293,30				K532409U € 252,50	K532408U € 353,20		
Ende einer Straße für Omnibusse § 53/24a 	470x470/2	K5324A03 € 50,10	K5324A02 € 70,20		K5324A03F € 93,20	K5324A02F € 100,60	K5324A03U € 86,20	K5324A02U € 106,00		
	630x630/2	K5324A06 € 84,30	K5324A05 € 118,80		K5324A06F € 173,50	K5324A05F € 185,30	K5324A06U € 120,60	K5324A05U € 156,80		
	960x960/2,5	K5324A09 € 203,30	K5324A08 € 293,30				K5324A09U € 252,50	K5324A08U € 353,20		
Fahrstreifen für Omnibusse § 53/25 	1200x600/2,5	K532506 € 188,10	K532505 € 236,60				K532506U € 259,60	K532505U € 322,10		
Ende eines Fahrstreifens für Omnibusse § 53/25a 	1200x600/2,5	K5325A06 € 188,10	K5325A05 € 236,60				K5325A06U € 259,60	K5325A05U € 322,10		
Fahrradstraße § 53/26 	470x470/2	K532603 € 50,10	K532602 € 70,20	K532601 € 86,70	K532603F € 93,20	K532602F € 100,60	K532601F € 105,80	K532603U € 86,20	K532602U € 106,00	K532601U € 125,50
	630x630/2	K532606 € 84,30	K532605 € 118,80	K532604 € 141,90	K532606F € 173,50	K532605F € 185,30	K532604F € 194,40	K532606U € 120,60	K532605U € 156,80	K532604U € 191,10
	960x960/2,5	K532609 € 203,30	K532608 € 293,30	K532607 € 365,20				K532609U € 252,50	K532608U € 353,20	K532607U € 415,50















VERKEHRSZEICHEN











HINWEISZEICHEN § 53	MASSE/ STÄRKE MM	AUSFÜHRUNG FLACH			AUSFÜHRUNG FORMLINE			AUSFÜHRUNG ALFORM		
		Folie EGP Type 1	Folie HIP Type 2	Folie DGV Type 3	Folie EGP Type 1	Folie HIP Type 2	Folie DGV Type 3	Folie EGP Type 1	Folie HIP Type 2	Folie DGV Type 3
Ende einer Fahrradstraße § 53/29a 	470x470/2	K5329A03 € 50,10	K5329A02 € 70,20	K5329A01 € 86,70	K5329A03F € 93,20	K5329A02F € 100,60	K5329A01F € 105,80	K5329A03U € 86,20	K5329A02U € 106,00	K5329A01U € 125,50
	630x630/2	K5329A06 € 84,30	K5329A05 € 118,80	K5329A04 € 141,90	K5329A06F € 173,50	K5329A05F € 185,30	K5329A04F € 194,40	K5329A06U € 120,60	K5329A05U € 156,80	K5329A04U € 191,10
	960x960/2,5	K5329A09 € 203,30	K5329A08 € 293,30	K5329A07 € 365,20				K5329A09U € 252,50	K5329A08U € 353,20	K5329A07U € 415,50
Schulstraße § 53/26a 	470x630/2	K5326A03 € 85,80	K5326A02 € 102,10	K5326A01 € 114,50	K5326A03F € 110,50	K5326A02F € 119,30	K5326A01F € 141,20	K5326A03U € 107,90	K5326A02U € 128,90	K5326A01U € 143,10
	630x960/2,5	K5326A06 € 162,80	K5326A05 € 205,30	K5326A04 € 236,30	K5326A06F € 192,90	K5326A05F € 263,50	K5326A04F € 280,80	K5326A06U € 194,40	K5326A05U € 243,30	K5326A04U € 270,70
	960x1200/3	K5326A09 € 260,80	K5326A08 € 342,40	K5326A07 € 432,50				K5326A09U € 323,80	K5326A08U € 425,10	K5326A07U € 501,00
Ende einer Schulstraße § 53/29 	470x630/2	K532903 € 85,80	K532902 € 102,10	K532901 € 114,50	K532903F € 110,50	K532902F € 119,30	K532901F € 141,20	K532903U € 107,90	K532902U € 128,90	K532901U € 143,10
	630x960/2,5	K532906 € 162,80	K532905 € 205,30	K532904 € 236,30	K532906F € 192,90	K532905F € 263,50	K532904F € 280,80	K532906U € 194,40	K532905U € 243,30	K532904U € 270,70
	960x1200/3	K532909 € 260,80	K532908 € 342,40	K532907 € 432,50				K532909U € 323,80	K532908U € 425,10	K532907U € 501,00
Radweg ohne Benützungspflicht § 53/27 	470x470/2	K532703 € 50,10	K532702 € 70,20	K532701 € 86,70	K532703F € 93,20	K532702F € 100,60	K532701F € 105,80	K532703U € 86,20	K532702U € 106,00	K532701U € 125,50
	630x630/2	K532706 € 84,30	K532705 € 118,80	K532704 € 141,90	K532706F € 173,50	K532705F € 185,30	K532704F € 194,40	K532706U € 120,60	K532705U € 156,80	K532704U € 191,10
	960x960/2,5	K532709 € 203,30	K532708 € 293,30	K532707 € 365,20				K532709U € 252,50	K532708U € 353,20	K532707U € 415,50
Ende eines Radweges ohne Benützungspflicht § 53/29b 	470x470/2	K532912 € 50,10	K532911 € 70,20	K532910 € 86,70	K532912F € 93,20	K532911F € 100,60	K532910F € 105,80	K532912U € 86,20	K532911U € 106,00	K532910U € 125,50
	630x630/2	K532915 € 84,30	K532914 € 118,80	K532913 € 141,90	K532915F € 173,50	K532914F € 185,30	K532913F € 194,40	K532915U € 120,60	K532914U € 156,80	K532913U € 191,10
	960x960/2,5	K532918 € 203,30	K532917 € 293,30	K532916 € 365,20				K532918U € 252,50	K532917U € 353,20	K532916U € 415,50
Geh- und Radweg ohne Benützungspflicht § 53/28a 	470x470/2	K5328A03 € 50,10	K5328A02 € 70,20	K5328A01 € 86,70	K5328A03F € 93,20	K5328A02F € 100,60	K5328A01F € 105,80	K5328A03U € 86,20	K5328A02U € 106,00	K5328A01U € 125,50
	630x630/2	K5328A06 € 84,30	K5328A05 € 118,80	K5328A04 € 141,90	K5328A06F € 173,50	K5328A05F € 185,30	K5328A04F € 194,40	K5328A06U € 120,60	K5328A05U € 156,80	K5328A04U € 191,10
	960x960/2,5	K5328A09 € 203,30	K5328A08 € 293,30	K5328A07 € 365,20				K5328A09U € 252,50	K5328A08U € 353,20	K5328A07U € 415,50
Ende eines Geh- und Radweges ohne Benützungspflicht § 53/29c gemeinsame Benützung 	470x470/2	K532921 € 50,10	K532920 € 70,20	K532919 € 86,70	K532921F € 93,20	K532920F € 100,60	K532919F € 105,80	K532921U € 86,20	K532920U € 106,00	K532919U € 125,50
	630x630/2	K532924 € 84,30	K532923 € 118,80	K532922 € 141,90	K532924F € 173,50	K532923F € 185,30	K532922F € 194,40	K532924U € 120,60	K532923U € 156,80	K532922U € 191,10
	960x960/2,5	K532927 € 203,30	K532926 € 293,30	K532925 € 365,20				K532927U € 252,50	K532926U € 353,20	K532925U € 415,50

HINWEISZEICHEN § 53	MASSE/ STÄRKE MM	AUSFÜHRUNG FLACH			AUSFÜHRUNG FORMLINE			AUSFÜHRUNG ALFORM		
		Folie EGP Type 1	Folie HIP Type 2	Folie DGV Type 3	Folie EGP Type 1	Folie HIP Type 2	Folie DGV Type 3	Folie EGP Type 1	Folie HIP Type 2	Folie DGV Type 3
Geh- und Radweg ohne Benützungspflicht §53/28b getrennte Benützung 	470x470/2	K5328B03 € 50,10	K5328B02 € 70,20	K5328B01 € 86,70	K5328B03F € 93,20	K5328B02F € 100,60	K5328B01F € 105,80	K5328B03U € 86,20	K5328B02U € 106,00	K5328B01U € 125,50
	630x630/2	K5328B06 € 84,30	K5328B05 € 118,80	K5328B04 € 141,90	K5328B06F € 173,50	K5328B05F € 185,30	K5328B04F € 194,40	K5328B06U € 120,60	K5328B05U € 156,80	K5328B04U € 191,10
	960x960/2,5	K5328B09 € 203,30	K5328B08 € 293,30	K5328B07 € 365,20				K5328B09U € 252,50	K5328B08U € 353,20	K5328B07U € 415,50
Anordnung bekanntgeben!										
Ende eines Geh- und Radweges ohne Benützungspflicht §53/29d getrennte Benützung 	470x470/2	K532930 € 50,10	K532929 € 70,20	K532928 € 86,70	K532930F € 93,20	K532929F € 100,60	K532928F € 105,80	K532930U € 86,20	K532929U € 106,00	K532928U € 125,50
	630x630/2	K532933 € 84,30	K532932 € 118,80	K532931 € 141,90	K532933F € 173,50	K532932F € 185,30	K532931F € 194,40	K532933U € 120,60	K532932U € 156,80	K532931U € 191,10
	960x960/2,5	K532936 € 203,30	K532935 € 293,30	K532934 € 365,20				K532936U € 252,50	K532935U € 353,20	K532934U € 415,50
Anordnung bekanntgeben!										
Hinweis auf Gewässer (einzeilig) §53 	470x310/2	KRVS190 € 47,60	KRVS189 € 59,60	KRVS188 € 68,20	KRVS190F € 73,40	KRVS189F € 77,80	KRVS188F € 79,50	KRVS190U € 74,90	KRVS189U € 96,40	KRVS188U € 99,10
	630x310/2	KRVS193 € 42,90	KRVS192 € 49,70	KRVS191 € 52,40	KRVS193F € 79,00	KRVS192F € 97,60	KRVS191F € 109,00	KRVS193U € 76,20	KRVS192U € 82,90	KRVS191U € 85,60
Hinweis auf Gewässer (zweizeilig) §53 	630x470/2	KRVS196 € 85,80	KRVS195 € 102,10	KRVS194 € 114,50	KRVS196F € 110,50	KRVS195F € 119,30	KRVS194F € 141,20	KRVS196U € 107,90	KRVS195U € 128,90	KRVS194U € 143,10
	960x630/2,5	KRVS199 € 162,80	KRVS198 € 205,30	KRVS197 € 236,30	KRVS199F € 192,90	KRVS198F € 263,50	KRVS197F € 280,80	KRVS199U € 194,40	KRVS198U € 243,30	KRVS197U € 270,70
Kennzeichnung von E-Strassen vor Kreuzungen §53 	470x630/2	KRVS283 € 85,80	KRVS282 € 102,10	KRVS281 € 114,50	KRVS283F € 110,50	KRVS282F € 119,30	KRVS281F € 141,20	KRVS283U € 107,90	KRVS282U € 128,90	KRVS281U € 143,10
Sonderausführung von Straßenverkehrszeichen §53 	2000x2000/3							KRVS6235A € 1.616,80	KRVS6234A € 2.032,60	KRVS6233A € 2.237,00
	2000x2500/3							KRVS6238A € 2.226,40	KRVS6237A € 2.544,20	KRVS6236A € 2.799,80
Hinweis auf Kettenanlageplatz §53 	630x960/2,5	KRVS445 € 162,80	KRVS444 € 205,30	KRVS443 € 236,30	KRVS445F € 192,90	KRVS444F € 263,50	KRVS443F € 280,80	KRVS445U € 194,40	KRVS444U € 243,30	KRVS443U € 270,70
	1000x1500/3	KRVS448 € 378,90	KRVS447 € 519,80	KRVS446 € 597,30				KRVS448U € 432,30	KRVS447U € 565,40	KRVS446U € 647,40



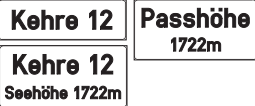





VERKEHRSZEICHEN

HINWEISZEICHEN § 53	MASSE/ STÄRKE MM	AUSFÜHRUNG FLACH			AUSFÜHRUNG FORMLINE			AUSFÜHRUNG ALFORM		
		Folie EGP Type 1	Folie HIP Type 2	Folie DGV Type 3	Folie EGP Type 1	Folie HIP Type 2	Folie DGV Type 3	Folie EGP Type 1	Folie HIP Type 2	Folie DGV Type 3
Sondertafel Schneeräumung LKW §53 	1000x1500/3	K5399S09 € 378,90	K5399S08 € 519,80	K5399S07 € 597,30				K5399S09U € 432,30	K5399S08U € 565,40	K5399S07U € 647,40
Hintergrund: zitronengelb neongelbe Ausführung gegen Aufpreis										
Hinweis auf Kettenanlegeplatz §53  	960x1200/3	KRVS457 € 260,80	KRVS456 € 342,40	KRVS455 € 432,50				KRVS457U € 323,80	KRVS456U € 425,10	KRVS455U € 501,00
Hinweis auf Kettenanlegeplatz §53 	960x630/2,5	KRVS466 € 162,80	KRVS465 € 205,30	KRVS464 € 236,30	KRVS466F € 192,90	KRVS465F € 263,50	KRVS464F € 280,80	KRVS466U € 194,40	KRVS465U € 243,30	KRVS464U € 270,70
Hinweis auf Kettenanlegeplatz §53 	960x630/2,5	KRVS475 € 162,80	KRVS474 € 205,30	KRVS473 € 236,30	KRVS475F € 192,90	KRVS474F € 263,50	KRVS473F € 280,80	KRVS475U € 194,40	KRVS474U € 243,30	KRVS473U € 270,70
Vorankündigung der Schneekettenanlegepflicht §53 	1000x1500/3 Einschübe 630x230/2 1500x2500/3 Einschübe 960x310/2	KRVS301 € 649,60	KRVS300 € 738,00	KRVS299 € 773,30				KRVS301U € 810,80	KRVS300U € 899,20	KRVS299U € 934,50
		KRVS304 € 61,20	KRVS303 € 84,40	KRVS302 € 93,80	beidseitige Ausführung gegen Aufpreis!					
								KRVS310A € 2.144,10	KRVS309A € 2.364,90	KRVS308A € 2.453,20
		KRVS313 € 64,90	KRVS312 € 91,10	KRVS311 € 126,30	beidseitige Ausführung gegen Aufpreis!					
Vorankündigung Gefahrenguttransport §53   	1500x2500/3							K5399S12A € 1.698,90	K5399S11A € 1.934,10	K5399S10A € 2.128,60
Leitwinkel blau/weiß §53 	470x700/2 600x900/2,5 800x1200/3		K5399G05 € 120,80	K5399G04 € 135,00				K5399G05U € 152,20	K5399G04U € 173,20	
			K5399G08 € 202,80	K5399G07 € 250,60				K5399G08U € 282,80	K5399G07U € 336,70	
			K5399G11 € 358,40	K5399G10 € 409,60				K5399G11U € 449,80	K5399G10U € 507,80	
Wegweiser §53 	2300x620/3 2600x700/3		K5399G14 € 598,00	K5399G13 € 664,70				K5399G14A € 672,70	K5399G13A € 758,60	
			K5399G17 € 690,80	K5399G16 € 770,90				K5399G17A € 898,00	K5399G16A € 1.009,30	
Objektbezeichnungstafel §53 	400x200/2	KRVS2410 € 45,20	KRVS2400 € 53,10	KRVS2390 € 61,60				KRVS2410U € 67,60	KRVS2400U € 79,90	KRVS2390U € 87,30

HINWEISZEICHEN § 53	MASSE/ STÄRKE MM	AUSFÜHRUNG FLACH			AUSFÜHRUNG FORMLINE			AUSFÜHRUNG ALFORM		
		Folie EGP	Folie HIP	Folie DGV	Folie EGP	Folie HIP	Folie DGV	Folie EGP	Folie HIP	Folie DGV
		Type 1	Type 2	Type 3	Type 1	Type 2	Type 3	Type 1	Type 2	Type 3
Ankündigung von Fahrbannteiler §53 	630x960/2,5	KRVS502 € 162,80	KRVS501 € 205,30	KRVS500 € 236,30	KRVS502F € 192,90	KRVS501F € 263,50	KRVS500F € 280,80	KRVS502U € 194,40	KRVS501U € 243,30	KRVS500U € 270,70
	1000x1500/3	KRVS505 € 378,90	KRVS504 € 519,80	KRVS503 € 597,30				KRVS505U € 432,30	KRVS504U € 565,40	KRVS503U € 647,40
Hinweis auf Pässe §53 	960x630/2,5		K5399H02 € 205,30	K5399H01 € 236,30		K5399H02F € 263,50	K5399H01F € 280,80		K5399H02U € 243,30	K5399H01U € 270,70
	1000x1500/3		K5399H05 € 519,80	K5399H04 € 597,30					K5399H05U € 565,40	K5399H04U € 647,40
	1200x960/3		K5399H08 € 342,40	K5399H07 € 432,50					K5399H08U € 425,10	K5399H07U € 501,00
	1500x1000/3		K5399H11 € 519,80	K5399H10 € 597,30					K5399H11U € 565,40	K5399H10U € 647,40
Hinweis Brücke, Talübergang §53 	1000x1500/3		K5399H14 € 519,80	K5399H13 € 597,30					K5399H14U € 565,40	K5399H13U € 647,40
Hinweis auf Sperren von Passstraßen §53 	1000x1500/3	KRVS412 € 649,60	KRVS411 € 738,00	KRVS410 € 773,30				KRVS412U € 810,80	KRVS411U € 899,20	KRVS410U € 934,50
	Einschübe 630x230/2	KRVS412E € 61,20	KRVS411E € 84,40	KRVS410E € 93,80	beidseitige Ausführung gegen Aufpreis!					
	1500x2500/3							KRVS418A € 2.144,10	KRVS417A € 2.364,90	KRVS416A € 2.453,20
	Einschübe 960x310/2	KRVS418E € 64,90	KRVS417E € 91,10	KRVS416E € 126,30	beidseitige Ausführung gegen Aufpreis!					
Hinweis auf Sperren von Passstraßen §53  	1000x1500/3	KRVS421 € 649,60	KRVS420 € 738,00	KRVS419 € 773,30				KRVS421U € 810,80	KRVS420U € 899,20	KRVS419U € 934,50
	Einschübe 630x230/2	KRVS421E € 61,20	KRVS420E € 84,40	KRVS419E € 93,80	beidseitige Ausführung gegen Aufpreis!					
	Einschübe 310x230/2	KRVS424E € 46,70	KRVS423E € 61,60	KRVS422E € 67,40	beidseitige Ausführung gegen Aufpreis!					
	1500x2500/3							KRVS433A € 2.144,10	KRVS432A € 2.364,90	KRVS431A € 2.453,20
	Einschübe 960x310/2	KRVS433E € 64,90	KRVS432E € 91,10	KRVS431E € 126,30	beidseitige Ausführung gegen Aufpreis!					
	Einschübe 470x310/2	KRVS433IE € 52,50	KRVS432IE € 70,70	KRVS431IE € 78,00	beidseitige Ausführung gegen Aufpreis!					
Kennzeichnung von Kehren, Pässen udgl. §53  	470x310/2	KRVS436 € 47,60	KRVS435 € 59,60	KRVS434 € 68,20	KRVS436F € 73,40	KRVS435F € 77,80	KRVS434F € 79,50	KRVS436U € 74,90	KRVS435U € 96,40	KRVS434U € 99,10
	960x310/2	KRVS439 € 64,90	KRVS438 € 91,10	KRVS437 € 126,30	KRVS439F € 101,90	KRVS438F € 110,70	KRVS437F € 142,80	KRVS439U € 98,80	KRVS438U € 123,00	KRVS437U € 159,90
	960x470/2,5	KRVS442 € 75,50	KRVS441 € 91,10	KRVS440 € 97,30				KRVS442U € 115,10	KRVS441U € 130,70	KRVS440U € 136,90
Hinweis für Fahrzeugbeleuchtung im Tunnel §53  	470x470/2 Anfang	KRVS508 € 50,10	KRVS507 € 70,20	KRVS506 € 86,70	KRVS508F € 93,20	KRVS507F € 100,60	KRVS506F € 105,80	KRVS508U € 86,20	KRVS507U € 106,00	KRVS506U € 125,50
	470x470/2 Ende	KRVS511 € 50,10	KRVS510 € 70,20	KRVS509 € 86,70	KRVS511F € 93,20	KRVS510F € 100,60	KRVS509F € 105,80	KRVS511U € 86,20	KRVS510U € 106,00	KRVS509U € 125,50
	630x630/2 Anfang	KRVS175 € 84,30	KRVS174 € 118,80	KRVS173 € 141,90	KRVS175F € 173,50	KRVS174F € 185,30	KRVS173F € 194,40	KRVS175U € 120,60	KRVS174U € 156,80	KRVS173U € 191,10
	630x630/2 Ende	KRVS178 € 84,30	KRVS177 € 118,80	KRVS176 € 141,90	KRVS178F € 173,50	KRVS177F € 185,30	KRVS176F € 194,40	KRVS178U € 120,60	KRVS177U € 156,80	KRVS176U € 191,10

















VERKEHRSZEICHEN

HINWEISZEICHEN § 53	MASSE/ STÄRKE MM	AUSFÜHRUNG FLACH			AUSFÜHRUNG FORMLINE			AUSFÜHRUNG ALFORM		
		Folie EGP Type 1	Folie HIP Type 2	Folie DGV Type 3	Folie EGP Type 1	Folie HIP Type 2	Folie DGV Type 3	Folie EGP Type 1	Folie HIP Type 2	Folie DGV Type 3
Hinweis für Motor abstellen §53 	470x470/2	KRVS181 € 50,10	KRVS180 € 70,20	KRVS179 € 86,70	KRVS181F € 93,20	KRVS180F € 100,60	KRVS179F € 105,80	KRVS181U € 86,20	KRVS180U € 106,00	KRVS179U € 125,50
	630x630/2	KRVS184 € 84,30	KRVS183 € 118,80	KRVS182 € 141,90	KRVS184F € 173,50	KRVS183F € 185,30	KRVS182F € 194,40	KRVS184U € 120,60	KRVS183U € 156,80	KRVS182U € 191,10
	960x960/2,5	KRVS187 € 203,30	KRVS186 € 293,30	KRVS185 € 365,20				KRVS187U € 252,50	KRVS186U € 353,20	KRVS185U € 415,50
Vorankündigungen von Fremdenverkehrseinrichtungen und Seilbahnen §53  	630x960/2,5	KRVS202 € 162,80	KRVS201 € 205,30	KRVS200 € 236,30	KRVS202F € 192,90	KRVS201F € 263,50	KRVS200F € 280,80	KRVS202U € 194,40	KRVS201U € 243,30	KRVS200U € 270,70
	630x1250/2,5	KRVS205 € 214,30	KRVS204 € 284,10	KRVS203 € 325,50				KRVS205U € 227,40	KRVS204U € 297,10	KRVS203U € 340,80
Ankündigung von Gewerbe- und Industriebetrieben §53 	1500x1000/3	KRVSG205 € 378,90	KRVSG204 € 519,80	KRVSG203 € 597,30				KRVSG205A € 432,30	KRVSG204A € 565,40	KRVSG203A € 647,40
	1500x1500/3	KRVSG208 € 587,60	KRVSG207 € 758,60	KRVSG206 € 919,90				KRVSG208A € 968,80	KRVSG207A € 1.146,70	KRVSG206A € 1.228,10
	2000x2000/3							KRVSG211A € 1.616,80	KRVSG210A € 2.032,60	KRVSG209A € 2.237,00
	2500x2500/3							KRVSG214A € 2.699,20	KRVSG213A € 3.189,20	KRVSG212A € 3.598,50
Sammeltafel für die Ankündigung von Gewerbe- u. Industriebetrieben §53 	1500x1500/3	KRVSG217 € 587,60	KRVSG216 € 758,60	KRVSG215 € 919,90				KRVSG217A € 968,80	KRVSG216A € 1.146,70	KRVSG215A € 1.228,10
	1500x2000/3							KRVSG220A € 1.239,60	KRVSG219A € 1.593,40	KRVSG218A € 1.788,80
	2000x2000/3							KRVSG223A € 1.616,80	KRVSG222A € 2.032,60	KRVSG221A € 2.237,00
	2500x2500/3							KRVSG226A € 2.699,20	KRVSG225A € 3.189,20	KRVSG224A € 3.598,50
Sonderausführung von Straßenverkehrszeichen §53  	1500x1500/3	KRVSG229 € 587,60	KRVSG228 € 758,60	KRVSG227 € 919,90				KRVSG229A € 968,80	KRVSG228A € 1.146,70	KRVSG227A € 1.228,10
	1500x2000/3							KRVSG232A € 1.239,60	KRVSG231A € 1.593,40	KRVSG230A € 1.788,80
	2000x2000/3							KRVSG235A € 1.616,80	KRVSG234A € 2.032,60	KRVSG233A € 2.237,00
	2000x2500/3							KRVSG238A € 2.226,40	KRVSG237A € 2.544,20	KRVSG236A € 2.799,80





WIR SETZEN ZEICHEN.

ITEK

UMLEITUNGSBESCHILDERUNG § 53		MASSE/ STÄRKE MM	AUSFÜHRUNG FLACH			AUSFÜHRUNG FORMLINE			AUSFÜHRUNG ALFORM		
			Folie EGP	Folie HIP	Folie DGV	Folie EGP	Folie HIP	Folie DGV	Folie EGP	Folie HIP	Folie DGV
			Type 1	Type 2	Type 3	Type 1	Type 2	Type 3	Type 1	Type 2	Type 3
Umleitungsbeschilderung § 53/16											
Umleitung §53/16b     	1150x250/2	K5316B10503 € 95,50	K5316B10502 € 121,50	K5316B10501 € 137,80	K5316B10503F € 115,00	K5316B10502F € 152,00	K5316B10501F € 168,00	K5316B10503U € 139,30	K5316B10502U € 167,40	K5316B10501U € 183,00	
	1460x330/2	K5316B14006 € 133,50	K5316B14005 € 183,30	K5316B14004 € 201,00				K5316B14006U € 204,20	K5316B14005U € 244,70	K5316B14004U € 275,10	
	1740x330/3	K5316B14003 € 184,60	K5316B14002 € 239,80	K5316B14001 € 272,30				K5316B14003U € 251,40	K5316B14002U € 321,40	K5316B14001U € 335,10	
	Auf Wunsch: Pfeil in lasergeschnittener Ausführung zum problemlosen Richtungswechsel - Aufpreis € 35,00 netto										
	1150x400/2	K5316B10513 € 127,80	K5316B10512 € 167,40	K5316B10511 € 191,50	K5316B10513F € 162,40	K5316B10512F € 200,90	K5316B10511F € 223,30	K5316B10513U € 169,10	K5316B10512U € 209,40	K5316B10511U € 231,20	
	1740x500/3	K5316B14013 € 251,00	K5316B14012 € 339,10	K5316B14011 € 377,90				K5316B14013U € 315,90	K5316B14012U € 412,30	K5316B14011U € 432,70	
	Auf Wunsch: Pfeil in lasergeschnittener Ausführung zum problemlosen Richtungswechsel - Aufpreis € 35,00 netto										
	1150x250/2	K5316B10523 € 95,50	K5316B10522 € 121,50	K5316B10521 € 137,80	K5316B10523F € 115,00	K5316B10522F € 152,00	K5316B10521F € 168,00	K5316B10523U € 139,30	K5316B10522U € 167,40	K5316B10521U € 183,00	
	1740x330/3	K5316B14023 € 184,60	K5316B14022 € 239,80	K5316B14021 € 272,30				K5316B14023U € 251,40	K5316B14022U € 321,40	K5316B14021U € 335,10	
	Umleitung alte Ausführung	1150x310/2	K5316B27 € 108,80	K5316B26 € 140,40	K5316B25 € 159,90	K5316B27F € 125,90	K5316B26F € 168,10	K5316B25F € 186,50	K5316B27U € 151,50	K5316B26U € 184,60	K5316B25U € 202,80
  	1740x460/3	K5316B30 € 237,20	K5316B29 € 319,70	K5316B28 € 356,00			K5316B30U € 302,50	K5316B29U € 393,30	K5316B28U € 412,40		
	2300x620/3	K5316B33 € 446,00	K5316B32 € 598,00	K5316B31 € 664,70			K5316B33A € 542,50	K5316B32A € 672,70	K5316B31A € 758,60		
Auf Wunsch: Pfeil in lasergeschnittener Ausführung zum problemlosen Richtungswechsel - Aufpreis € 35,00 netto											
Vorankündigung einer Umleitung §53/16a  	1300x2000/3	K5316A03 € 671,80	K5316A02 € 943,40	K5316A01 € 1.108,20			K5316A03A € 1.013,50	K5316A02A € 1.242,50	K5316A01A € 1.481,20		
	1500x2500/3						K5316A06A € 1.698,90	K5316A05A € 1.934,10	K5316A04A € 2.128,60		
Umleitungstafel mit 3 Einschubleisten für einschiebbare Einzelbuchstaben 	3-zeilig: 1500x1000/3						K5399B03U € 810,80	K5399B02U € 899,20	K5399B01U € 934,50		
	Einzelbuchstabe	K5399B06 € 43,20	K5399B05 € 50,20	K5399B04 € 54,30							
	4-zeilig: 2500x1500/3						K5399B09A € 2.144,10	K5399B08A € 2.364,90	K5399B07A € 2.453,20		
Umleitungsbeschilderung    	470x630/2	KRVSS32 € 85,80	KRVSS31 € 102,10	KRVSS30 € 114,50	KRVSS32F € 110,50	KRVSS31F € 119,30	KRVSS30F € 141,20	KRVSS32U € 107,90	KRVSS31U € 128,90	KRVSS30U € 143,10	
	630x470/2	KRVSS14 € 85,80	KRVSS13 € 102,10	KRVSS12 € 114,50	KRVSS14F € 110,50	KRVSS13F € 119,30	KRVSS12F € 141,20	KRVSS14U € 107,90	KRVSS13U € 128,90	KRVSS12U € 143,10	
	1000x500/3	KRVSS17 € 166,20	KRVSS16 € 210,00	KRVSS15 € 233,70				KRVSS17U € 198,60	KRVSS16U € 238,50	KRVSS15U € 275,20	



VERKEHRSZEICHEN

UMLEITUNGSBESCHILDERUNG § 53	MASSE/ STÄRKE MM	AUSFÜHRUNG FLACH			AUSFÜHRUNG FORMLINE			AUSFÜHRUNG ALFORM		
		Folie EGP Type 1	Folie HIP Type 2	Folie DGV Type 3	Folie EGP Type 1	Folie HIP Type 2	Folie DGV Type 3	Folie EGP Type 1	Folie HIP Type 2	Folie DGV Type 3
Kennzeichnung einer Pannenbucht 	960x1200/3	KRVSP532 € 260,80	KRVSP531 € 342,40	KRVSP530 € 432,50				KRVSP532U € 323,80	KRVSP531U € 425,10	KRVSP530U € 501,00
	1000x1500/3	KRVSP535 € 378,90	KRVSP534 € 519,80	KRVSP533 € 597,30				KRVSP535U € 432,30	KRVSP534U € 565,40	KRVSP533U € 647,40
Klapptafel Vorankündigung "Stau" 	1000x2000/3	KRVSK532 € 1.376,50	KRVSK531 € 1.531,10	KRVSK530 € 1.592,90				KRVSK532A € 1.621,20	KRVSK531A € 1.927,80	KRVSK530A € 1.989,60
Vorwarntafel V1 §53/16c 	1000x2000/3	K5316C03 € 488,10	K5316C02 € 691,50	K5316C01 € 813,80				K5316C03A € 705,40	K5316C02A € 899,80	K5316C01A € 1.045,40
Vorwarntafel V4 §53/16c 	960x960/2,5	K5316C12 € 203,30	K5316C11 € 293,30	K5316C10 € 365,20				K5316C12A € 252,50	K5316C11A € 353,20	K5316C10A € 415,50
	960x310/2 Zusatztafel	K5316C15 € 64,90	K5316C14 € 91,10	K5316C13 € 126,30				K5316C15A € 98,80	K5316C14A € 123,00	K5316C13A € 159,90
Vorwarntafel V3 §53/16c 	2000x1500/3	K5316C09 € 698,40	K5316C08 € 940,40	K5316C07 € 1.150,00				K5316C09A € 1.105,50	K5316C08A € 1.365,00	K5316C07A € 1.507,90

UMLEITUNGSBESCHILDERUNG § 53

Voranzeiger für Fahrstreifenverlauf
F1- F20 sowie W1 - W6

§53/16c

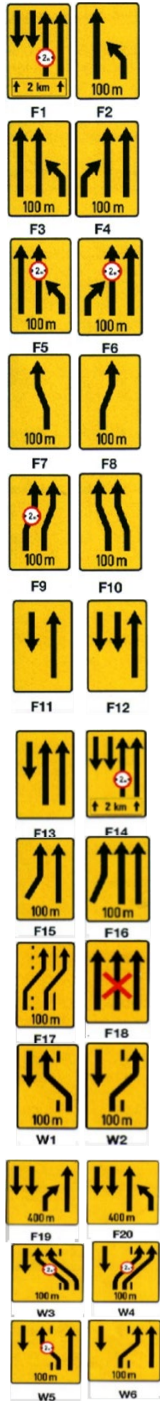

MASSE/ STÄRKE MM	AUSFÜHRUNG FLACH			AUSFÜHRUNG FORMLINE			AUSFÜHRUNG ALFORM		
	Folie EGP	Folie HIP	Folie DGV	Folie EGP	Folie HIP	Folie DGV	Folie EGP	Folie HIP	Folie DGV
	Type 1	Type 2	Type 3	Type 1	Type 2	Type 3	Type 1	Type 2	Type 3
1000x1500/3 F1	K5316C18 € 378,90	K5316C17 € 519,80	K5316C16 € 597,30				K5316C18A € 432,30	K5316C17A € 565,40	K5316C16A € 647,40
1000x1500/3 F2	K5316C21 € 378,90	K5316C20 € 519,80	K5316C19 € 597,30				K5316C21A € 432,30	K5316C20A € 565,40	K5316C19A € 647,40
	Ausführung in Klappvariante:								
	K5316CKL21 € 1.056,40	K5316CKL20 € 1.188,90	K5316CKL19 € 1.241,90				K5316CKL21U € 1.006,80	K5316CKL20U € 1.122,70	K5316CKL19U € 1.169,10
1000x1500/3 F3	K5316C24 € 378,90	K5316C23 € 519,80	K5316C22 € 597,30				K5316C24A € 432,30	K5316C23A € 565,40	K5316C22A € 647,40
1000x1500/3 F4	K5316C27 € 378,90	K5316C26 € 519,80	K5316C25 € 597,30				K5316C27A € 432,30	K5316C26A € 565,40	K5316C25A € 647,40
1000x1500/3 F5	K5316C30 € 378,90	K5316C29 € 519,80	K5316C28 € 597,30				K5316C30A € 432,30	K5316C29A € 565,40	K5316C28A € 647,40
1000x1500/3 F6	K5316C33 € 378,90	K5316C32 € 519,80	K5316C31 € 597,30				K5316C33A € 432,30	K5316C32A € 565,40	K5316C31A € 647,40
1000x1500/3 F7	K5316C36 € 378,90	K5316C35 € 519,80	K5316C34 € 597,30				K5316C36A € 432,30	K5316C35A € 565,40	K5316C34A € 647,40
1000x1500/3 F8	K5316C39 € 378,90	K5316C38 € 519,80	K5316C37 € 597,30				K5316C39A € 432,30	K5316C38A € 565,40	K5316C37A € 647,40
1000x1500/3 F9	K5316C42 € 378,90	K5316C41 € 519,80	K5316C40 € 597,30				K5316C42A € 432,30	K5316C41A € 565,40	K5316C40A € 647,40
1000x1500/3 F10	K5316C45 € 378,90	K5316C44 € 519,80	K5316C43 € 597,30				K5316C45A € 432,30	K5316C44A € 565,40	K5316C43A € 647,40
1000x1500/3 F11	K5316C48 € 378,90	K5316C47 € 519,80	K5316C46 € 597,30				K5316C48A € 432,30	K5316C47A € 565,40	K5316C46A € 647,40
1000x1500/3 F12	K5316C51 € 378,90	K5316C50 € 519,80	K5316C49 € 597,30				K5316C51A € 432,30	K5316C50A € 565,40	K5316C49A € 647,40
1000x1500/3 F13	K5316C54 € 378,90	K5316C53 € 519,80	K5316C52 € 597,30				K5316C54A € 432,30	K5316C53A € 565,40	K5316C52A € 647,40
1000x1500/3 F14	K5316C57 € 378,90	K5316C56 € 519,80	K5316C55 € 597,30				K5316C57A € 432,30	K5316C56A € 565,40	K5316C55A € 647,40
1000x1500/3 F15	K5316C60 € 378,90	K5316C59 € 519,80	K5316C58 € 597,30				K5316C60A € 432,30	K5316C59A € 565,40	K5316C58A € 647,40
1000x1500/3 F16	K5316C63 € 378,90	K5316C62 € 519,80	K5316C61 € 597,30				K5316C63A € 432,30	K5316C62A € 565,40	K5316C61A € 647,40
1000x1500/3 F18	K5316C66 € 378,90	K5316C65 € 519,80	K5316C64 € 597,30				K5316C66A € 432,30	K5316C65A € 565,40	K5316C64A € 647,40
1000x1500/3 F17	K5316C69 € 378,90	K5316C68 € 519,80	K5316C67 € 597,30				K5316C69A € 432,30	K5316C68A € 565,40	K5316C67A € 647,40
1000x1500/3 F18	K5316C69 € 378,90	K5316C68 € 519,80	K5316C67 € 597,30				K5316C69A € 432,30	K5316C68A € 565,40	K5316C67A € 647,40
1000x1500/3 W1	K5316C72 € 378,90	K5316C71 € 519,80	K5316C70 € 597,30				K5316C72A € 432,30	K5316C71A € 565,40	K5316C70A € 647,40
1000x1500/3 W2	K5316C75 € 378,90	K5316C74 € 519,80	K5316C73 € 597,30				K5316C75A € 432,30	K5316C74A € 565,40	K5316C73A € 647,40
1500x1500/3 F19	K5316C78 € 587,60	K5316C77 € 758,60	K5316C76 € 919,90				K5316C78A € 968,80	K5316C77A € 1.146,70	K5316C76A € 1.228,10
1500x1500/3 F20	K5316C81 € 587,60	K5316C80 € 758,60	K5316C79 € 919,90				K5316C81A € 968,80	K5316C80A € 1.146,70	K5316C79A € 1.228,10
1500x1500/3 W3	K5316C84 € 587,60	K5316C83 € 758,60	K5316C82 € 919,90				K5316C84A € 968,80	K5316C83A € 1.146,70	K5316C82A € 1.228,10
1500x1500/3 W4	K5316C87 € 587,60	K5316C86 € 758,60	K5316C85 € 919,90				K5316C87A € 968,80	K5316C86A € 1.146,70	K5316C85A € 1.228,10
1500x1500/3 W5	K5316C90 € 587,60	K5316C89 € 758,60	K5316C88 € 919,90				K5316C90A € 968,80	K5316C89A € 1.146,70	K5316C88A € 1.228,10
1500x1500/3 W6	K5316C93 € 587,60	K5316C92 € 758,60	K5316C91 € 919,90				K5316C93A € 968,80	K5316C92A € 1.146,70	K5316C91A € 1.228,10

Alle Voranzeiger für Fahrstreifenverlauf mit austauschbaren, lasergeschnittenen Pfeilen lieferbar: Aufpreis von € 45,00 netto pro Pfeil

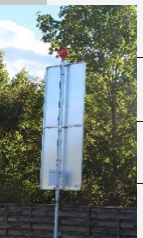

VERKEHRSZEICHEN

UMLEITUNGSBESCHILDERUNG § 53	MASSE/ STÄRKE MM	AUSFÜHRUNG FLACH			AUSFÜHRUNG FORMLINE			AUSFÜHRUNG ALFORM		
		Folie EGP Type 1	Folie HIP Type 2	Folie DGV Type 3	Folie EGP Type 1	Folie HIP Type 2	Folie DGV Type 3	Folie EGP Type 1	Folie HIP Type 2	Folie DGV Type 3
		Vorwarntafel V2 §53/16c	1000x2500/3	K5316C06 € 729,90	K5316C05 € 955,60	K5316C04 € 1.091,40				K5316C06A € 1.052,90
Preis inkl. einem beidseitig belegten austauschbaren Verkehrszeichen										
zus. austauschbares VZ		K5316CVZ3 € 98,30	K5316CVZ2 € 120,30	K5316CVZ1 € 135,40						
unteres VZ in Klappvariante		K5316CKL3 € 203,40	K5316CKL2 € 229,10	K5316CKL1 € 246,80						
Aufpreis 1 Blitzleuchte inkl. Halterungskonstruktion und Batterien:										
		KPBB200V2 € 626,20								



WIR SETZEN ZEICHEN.



Aufpreis 1 Blitzleuchte inkl. Halterungskonstruktion und Batterien:



WIR FÜHREN NUR GUTES IM SCHILDE.





ZUSATZTAFELN § 54	MASSE/ STÄRKE MM	AUSFÜHRUNG FLACH			AUSFÜHRUNG FORMLINE			AUSFÜHRUNG ALFORM		
		Folie EGP	Folie HIP	Folie DGV	Folie EGP	Folie HIP	Folie DGV	Folie EGP	Folie HIP	Folie DGV
		Type 1	Type 2	Type 3	Type 1	Type 2	Type 3	Type 1	Type 2	Type 3
Preise für Zusatztafel ohne Beschriftung bzw. Symbole	310x150/2	K540103 € 27,30	K540102 € 29,00	K540101 € 29,70	K540103F € 40,30	K540102F € 41,80	K540101F € 42,30	K540103U € 48,80	K540102U € 50,50	K540101U € 51,10
	310x310/2	K540106 € 32,50	K540105 € 35,90	K540104 € 37,30	K540106F € 51,30	K540105F € 54,30	K540104F € 55,40	K540106U € 61,60	K540105U € 65,00	K540104U € 66,30
Preis pro Zeile € 10,00 es werden max. 3 Zeilen verrechnet	400x150/2	K540109 € 28,40	K540108 € 30,40	K540107 € 31,20				K540109U € 56,50	K540108U € 58,50	K540107U € 59,40
	470x150/2	K540112 € 30,50	K540111 € 33,20	K540110 € 34,20	K540112F € 48,30	K540111F € 50,70	K540110F € 51,60	K540112U € 59,50	K540111U € 62,20	K540110U € 63,30
Preis für Standardsymbol: € 15,00 es werden max. 3 Symbole verrechnet	470x230/2	K540115 € 33,60	K540114 € 37,30	K540113 € 38,80	K540115F € 64,10	K540114F € 67,40	K540113F € 68,70	K540115U € 63,70	K540114U € 67,40	K540113U € 68,90
	470x310/2	K540118 € 37,70	K540117 € 42,80	K540116 € 44,80	K540118F € 73,40	K540117F € 77,80	K540116F € 79,50	K540118U € 68,90	K540117U € 74,00	K540116U € 76,00
	470x470/2	K540121 € 46,10	K540120 € 53,90	K540119 € 57,00	K540121F € 93,20	K540120F € 100,60	K540119F € 105,80	K540121U € 79,30	K540120U € 87,10	K540119U € 90,20
	630x230/2	K540124 € 37,70	K540123 € 42,80	K540122 € 44,80	K540124F € 65,40	K540123F € 69,80	K540122F € 71,50	K540124U € 69,90	K540123U € 75,00	K540122U € 85,60
	630x310/2	K540127 € 42,90	K540126 € 49,70	K540125 € 52,40	K540127F € 79,00	K540126F € 97,60	K540125F € 109,00	K540127U € 76,20	K540126U € 82,90	K540125U € 85,60
	630x470/2	K540130 € 53,30	K540129 € 63,50	K540128 € 67,60	K540130F € 110,50	K540129F € 119,30	K540128F € 122,80	K540130U € 88,70	K540129U € 98,80	K540128U € 102,90
	630x630/2	K540133 € 69,30	K540132 € 82,80	K540131 € 88,20	K540133F € 173,50	K540132F € 185,30	K540131F € 194,40	K540133U € 106,70	K540132U € 120,20	K540131U € 125,60
	960x310/2	K540136 € 53,30	K540135 € 63,50	K540134 € 67,60	K540136F € 101,90	K540135F € 110,70	K540134F € 114,20	K540136U € 90,90	K540135U € 101,00	K540134U € 105,10
	960x470/2	K540139 € 75,50	K540138 € 91,10	K540137 € 97,30				K540139U € 115,10	K540138U € 130,70	K540137U € 136,90
	960x630/2,5	K540142 € 103,30	K540141 € 124,00	K540140 € 132,20	K540142F € 192,90	K540141F € 210,80	K540140F € 218,00	K540142U € 154,20	K540141U € 174,90	K540140U € 183,10
	960x960/2,5	K540145 € 155,90	K540144 € 187,40	K540143 € 200,00				K540145U € 207,40	K540144U € 238,90	K540143U € 251,50
	1150x310/2	K540148 € 108,80	K540147 € 140,40	K540146 € 159,90	K540148F € 125,90	K540147F € 168,10	K540146F € 186,50	K540148U € 151,50	K540147U € 184,60	K540146U € 202,80

VZ-Größe	Zusatztafel- format
Gr. 480	310x150 310x310 400x150
Gr. 670	470x150
Gr. 700	470x230 470x310
Gr. 960	630x230
Gr. 1000	630x310 630x470 630x630
Gr. 1200	960x310
Gr. 1500	960x470 960x630 960x960 1150x310

Besondere Zusatztafel-formate							
Seitenlänge [mm]	100m	↑ 3 km ↑					
700	310 x 150 mm	470 x 230 mm	310 x 310 mm	470 x 310 mm	630 x 470 mm		
1000 1500	630 x 310 mm	960 x 310 mm	630 x 470 mm	960 x 470 mm	960 x 630 mm		
Durchmesser [mm]	Anfang Ende	ausgenommen 	ausgenommen 	1-zeilig	2-zeilig	3-zeilig	4-zeilig
480 670	310 x 150 mm	470 x 310 mm	470 x 310 mm	470 x 150 mm	470 x 230 mm	470 x 310 mm	470 x 470 mm
960 1200	470 x 230 mm	630 x 470 mm	-----	960 x 310 mm	960 x 470 mm	960 x 630 mm	960 x 960 mm
Seitenlänge [mm]			STOP 100m				
700	310 x 310 mm	310 x 150 mm	470 x 230 mm				
1000	470 x 470 mm	470 x 230 mm	630 x 310 mm				
630 x 630	310 x 310 mm	470 x 230 mm					
940 x 940	470 x 470 mm	630 x 310 mm					



Übersicht Zusatztafeln lt. Verkehrszeichenkatalog, in den gesetzlich vorgeschriebenen Größen

a) Gr. 310x150, 630x310

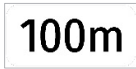

b) 470x230, 960x310



c) 470x230, 630x310



d) Gr. 310x150, 470x230, 630x310



e) Gr. 310x310, 470x470, 630x630, 960x960



f) Gr. 630x310



g) Gr. 310x310, 630x470



h) Gr. 470x230



i) Gr. 470x310, 630x470



j) Gr. 470x230



k) Gr. 960x470



l) Gr. 630x470



Auf folgende Standardschilder gelten die Grundpreise:

Die Artikelnummer setzt sich aus der Grundtafel und der laufenden Nummer zusammen!

z.B. K540106V1 = Zusatztafel "Verlauf Vorrangstraße" in Gr. 310x310, Folie Type 1 (K-540106) und ergänzt um die laufende Nummer V1 aus dem Standardprogramm!

Standardschilder "Verlauf Vorrangstraße" im Format: 310x310/2, 470x470/2, 630x630/2, 960x960/2,5 bzw. 310x150/2, 470x230/2 und 630x310/2

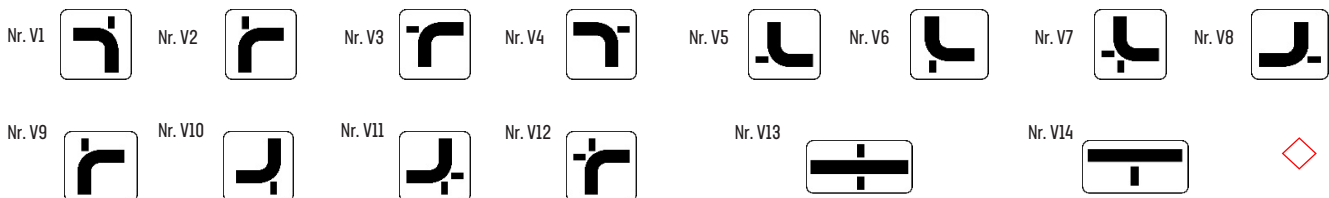

Standardschilder im Format: 310x150/2

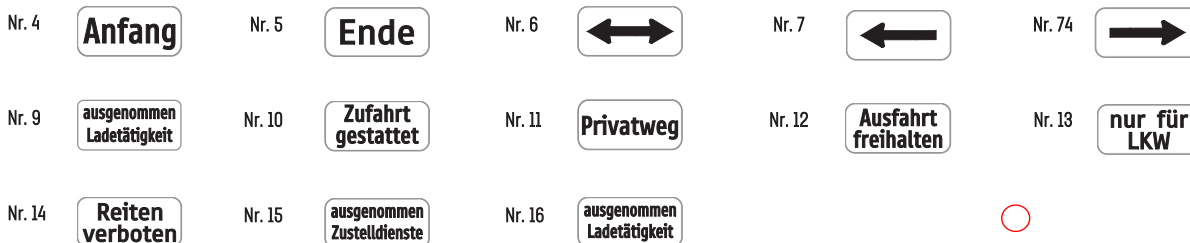

Standardschilder im Format: 310x310/2



Standardschilder im Format: 470x150/2

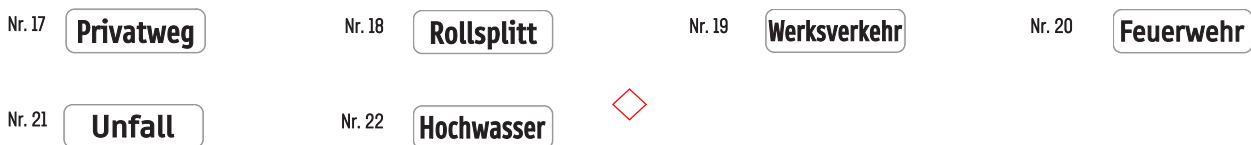

WIR SETZEN ZEICHEN.



ZUSATZTAFELN § 54

Zusatztafeln lt. Verkehrszeichenkatalog und ITEK-Standardprogramm

Standardschilder im Format: 470x230/2

Nr. 24	Anfang	Nr. 25	Ende	Nr. 26		Nr. 27	Privatweg
Nr. 28	Rollsplitt	Nr. 29	kurvenreiche Strecke	Nr. 30	bei Nässe und Glatteis	Nr. 31	Ausfahrt freihalten
Nr. 32	ausgenommen Anrainer	Nr. 33	ausgenommen Zustelldienste	Nr. 34	Hier gilt die StVO!	Nr. 35	ausgenommen Anrainerverkehr
Nr. 36	ausgenommen 	Nr. 37	 Abschleppzone	Nr. 38	Bodenmarkierung ungültig		

Standardschilder im Format: 470x310/2

Nr. 39	Wintersperre keine Schneeräumung keine Sandstreuung Benützung auf eigene Gefahr!	Nr. 40	ausgenommen 	Nr. 41	ausgenommen 	Nr. 42	Privatgrundstück Widerrechtlich abgestellte Fahrzeuge werden kostenpflichtig abgeschleppt!	Nr. 75	ausgenommen
--------	--	--------	------------------------	--------	------------------------	--------	--	--------	------------------------

Standardschilder im Format: 630x230/2

Nr. 43	Ortsgebiet	Nr. 44	Unfall	Nr. 45	Vermessung	Nr. 46	Leitungsbau
Nr. 47	FEUERWEHR	Nr. 48	Rollsplitt	Nr. 49	Fahrbahnschäden	Nr. 50	Hochwasser

Standardschilder im Format: 630x310/2

Nr. 51	Hier gilt die StVO!	Nr. 52	ausgenommen Anrainerverkehr	Nr. 53	Bankette nicht befahrbar!	Nr. 54	Feuerwehrzufahrt
Nr. 56	ausgenommen 	Nr. 57	ausgenommen Busse	Nr. 58		Nr. 59	
Nr. 60		Nr. 61	ausgenommen Einsatzfahrzeuge	Nr. 62	ausgenommen 		
Nr. 73	Abstand halten! 	Nr. 74	mind. 2m 	Nr. 75	mind. 1,5m 		









Standardschilder im Format: 630x470/2

Nr. 63	 beim Variieren	Nr. 64	ausgenommen 	Nr. 66	 Rollsplitt	Nr. 67	 Bankette frisch geschüttet	Nr. 68	 Bankette in Arbeit
--------	---------------------------	--------	------------------------	--------	-----------------------	--------	---------------------------------------	--------	-------------------------------

Standardschilder im Format: 960x470/2

Nr. 69		Nr. 70		Nr. 71		Nr. 72	ausgenommen
--------	--	--------	--	--------	--	--------	------------------------

VERKEHRSZEICHEN

SONDERTAFELN NACH RVS	MASSE/ STÄRKE MM	AUSFÜHRUNG FLACH			AUSFÜHRUNG FORMLINE			AUSFÜHRUNG ALFORM		
		Folie EGP	Folie HIP	Folie DGV	Folie EGP	Folie HIP	Folie DGV	Folie EGP	Folie HIP	Folie DGV
		Type 1	Type 2	Type 3	Type 1	Type 2	Type 3	Type 1	Type 2	Type 3
RVS Richtungstafel/Leitplanke rot/weiss  gelb/rot - fluoreszierend 	1150x310/2	KRVS164 € 108,80	KRVS163 € 140,40	KRVS162 € 159,90				KRVS164U € 151,50	KRVS163U € 184,60	KRVS162U € 202,80
	2000x470/3	KRVS106 € 222,80	KRVS105 € 290,70	KRVS104 € 374,50				KRVS106U € 319,30	KRVS105U € 386,30	KRVS104U € 452,80
	2500x620/3	KRVS167 € 411,00	KRVS166 € 532,90	KRVS165 € 597,50				KRVS167U € 454,40	KRVS166U € 575,20	KRVS165U € 642,00
	1150x310/2			KRVSNI62 € 275,80						KRVSNI62U € 299,40
	2000x470/3			KRVSNI04 € 626,60						KRVSNI04U € 728,70
	2500x620/3			KRVSNI65 € 1.013,10						KRVSNI65U € 1.149,30
	1150x310/2	KRVS170 € 108,80	KRVS169 € 140,40	KRVS168 € 159,90				KRVS170U € 151,50	KRVS169U € 184,60	KRVS168U € 202,80
	2000x470/3	KRVS173FT € 222,80	KRVS172FT € 290,70	KRVS171FT € 374,50				KRVS173FTU € 319,30	KRVS172FTU € 386,30	KRVS171FTU € 452,80
	2500x620/3	KRVS176FT € 411,00	KRVS175FT € 532,90	KRVS174FT € 597,50				KRVS176FTU € 454,40	KRVS175FTU € 575,20	KRVS174FTU € 642,00
RVS Fahrbahnteiler rot/weiss  gelb/rot - fluoreszierend 	1150x310/2			KRVSNI68 € 275,80						KRVSNI68U € 299,40
	2000x470/3			KRVSNI71 € 626,60						KRVSNI71U € 728,70
	2500x620/3			KRVSNI74 € 1.013,10						KRVSNI74U € 1.149,30
	250x630/2	KRVS1115 € 59,00	KRVS1114 € 67,20	KRVS1113 € 76,60				KRVS1115U € 92,90	KRVS1114U € 109,90	KRVS1113U € 119,90
	250x1000/2	KRVS115 € 62,80	KRVS114 € 81,20	KRVS113 € 104,30				KRVS115U € 118,80	KRVS114U € 138,70	KRVS113U € 160,70
	310x1250/2	KRVS2115 € 81,80	KRVS2114 € 108,90	KRVS2113 € 141,20				KRVS2115U € 144,70	KRVS2114U € 173,30	KRVS2113U € 202,40
RVS Leitbaken (Winkelform) rot/weiss  rechts links gelb/rot - fluoreszierend  rechts links	250x630/2			KRVSNI113 € 123,50						KRVSNI113U € 179,90
	250x1000/2			KRVS122 € 171,30						KRVS122U € 236,10
	310x1250/2			KRVSNI2113 € 245,80						KRVSNI2113U € 317,60
RVS Leitmal (Schraffenbreite 180mm) rot/weiss  gelb/rot - fluoreszierend 	Höhe: 250/2 per lfm.	KRVSL103 € 62,80	KRVSL102 € 81,20	KRVSL101 € 104,30						
	Höhe: 250/2 per lfm.			KRVSLNI01 € 171,30						



SCHILDER VON WELT MIT UMWELTEFFEKT.

ITEK

SONDERTAFELN NACH RVS	MASSE/ STÄRKE MM	AUSFÜHRUNG FLACH			AUSFÜHRUNG FORMLINE			AUSFÜHRUNG ALFORM		
		Folie EGP	Folie HIP	Folie DGV	Folie EGP	Folie HIP	Folie DGV	Folie EGP	Folie HIP	Folie DGV
		Type 1	Type 2	Type 3	Type 1	Type 2	Type 3	Type 1	Type 2	Type 3
Sonderleitbaken für Inseln und Rückbauten RVS Aluminium gekantet ohne §52/15 ohne Laschen Ausführung Pfeilform  fluoreszierend										
	250x630 rot/weiss		KRVS129 € 277,00	KRVS128 € 287,10						
	250x630 gelb/rot			KRVS131 € 402,10						
Standardausführung Pfeilform  fluoreszierend	250x630 rot/weiss		KRVS129G € 277,00	KRVS128G € 287,10						
	250x630 gelb/rot			KRVS131G € 402,10						
Sonderausführung gerade  fluoreszierend	250x630 rot/weiss		KRVS129SR € 277,00	KRVS128SR € 287,10						
	250x630 gelb/rot			KRVS131SR € 402,10						
Sonderausführung schräg rechts  fluoreszierend	250x630 rot/weiss		KRVS129SL € 277,00	KRVS128SL € 287,10						
	250x630 gelb/rot			KRVS131SL € 402,10						
Sonderausführung schräg links  fluoreszierend	250x630 rot/weiss		KRVS141 € 120,80	KRVS140 € 135,00			KRVS141U € 152,20	KRVS140U € 173,20		
	600x900/2,5		KRVS144 € 202,80	KRVS143 € 250,60			KRVS144U € 282,80	KRVS143U € 336,70		
Rechteckiger Leitwinkel RVS rot/weiss  gelb/rot - fluoreszierend 	800x1200/3		KRVS147 € 358,40	KRVS146 € 409,60			KRVS147U € 449,80	KRVS146U € 507,80		
	1000x1500/3		KRVS150 € 519,80	KRVS149 € 597,30			KRVS150U € 565,40	KRVS149U € 647,40		
	470x700/2			KRVS152 € 223,50				KRVS152U € 286,50		
	600x900/2,5			KRVS155 € 360,30				KRVS155U € 440,40		
	800x1200/3			KRVS158 € 638,40				KRVS158U € 729,80		
1000x1500/3			KRVS161 € 999,50				KRVS161U € 1.083,70			

DIGITALDRUCK MACHT EINDRUCK. 



VERKEHRSZEICHEN

SONSTIGE INFORMATIONSSCHILDER	MASSE/ STÄRKE MM	AUSFÜHRUNG FLACH			AUSFÜHRUNG FORMLINE			AUSFÜHRUNG ALFORM		
		Folie EGP	Folie HIP	Folie DGV	Folie EGP	Folie HIP	Folie DGV	Folie EGP	Folie HIP	Folie DGV
		Type 1	Type 2	Type 3	Type 1	Type 2	Type 3	Type 1	Type 2	Type 3
Kombiniertes Verkehrszeichen 	700x836/2	KINF03M	KINF02M	KINF01M						
	1000x1176/2,5	KINF03	KINF02	KINF01						
		€ 166,30	€ 198,70	€ 222,90						
Sondertafel Fahrradenker rechts abbiegen erlaubt 	310x470/2	K54012901A_1	K54012901A_2	K54012901A_3	K54012901A_1F	K54012901A_2F	K54012901A_3F	K54012901A_1U	K54012901A_2	K54012901A_3U
	470x630/2	K54012901_1	K54012901_2	K54012901_3	K54012901_1F	K54012901_2F	K54012901_3F	K54012901_1U	K54012901_2U	K54012901_3U
		€ 60,70	€ 68,90	€ 76,00	€ 73,40	€ 77,80	€ 91,50	€ 83,80	€ 96,40	€ 105,70
Sondertafel Fahrradenker geradeaus fahren erlaubt 	310x470/2	K54012902A_1	K54012902A_2	K54012902A_3	K54012902A_1F	K54012902A_2	K54012902A_3	K54012902A_1	K54012902A_2	K54012902A_3
	470x630/2	K54012902_1	K54012902_2	K54012902_3	K54012902_1F	K54012902_2F	K54012902_3F	K54012902_1U	K54012902_2U	K54012902_3U
		€ 60,70	€ 68,90	€ 76,00	€ 73,40	€ 77,80	€ 91,50	€ 83,80	€ 96,40	€ 105,70
NO GPS 	470x630/2	KINF15	KINF14	KINF13	KINF15F	KINF14F	KINF13F	KINF15U	KINF14U	KINF13U
	630x960/2,5	KINF18	KINF17	KINF16	KINF18F	KINF17F	KINF16F	KINF18U	KINF17U	KINF16U
		€ 85,80	€ 102,10	€ 114,50	€ 110,50	€ 119,30	€ 141,20	€ 107,90	€ 128,90	€ 143,10
E-Tankstelle 	470x630/2	KINF95	KINF94	KINF93	KINF95F	KINF94F	KINF93F	KINF95U	KINF94U	KINF93U
	630x960/2,5	KINF98	KINF97	KINF96	KINF98F	KINF97F	KINF96F	KINF98U	KINF97U	KINF96U
		€ 85,80	€ 102,10	€ 114,50	€ 110,50	€ 119,30	€ 141,20	€ 107,90	€ 128,90	€ 143,10
P+R-Schild 	470x630/2	KINF105	KINF104	KINF103	KINF105F	KINF104F	KINF103F	KINF105U	KINF104U	KINF103U
	630x960/2,5	KINF108	KINF107	KINF106	KINF108F	KINF107F	KINF106F	KINF108U	KINF107U	KINF106U
		€ 85,80	€ 102,10	€ 114,50	€ 110,50	€ 119,30	€ 141,20	€ 107,90	€ 128,90	€ 143,10
Wegweiser Polizei 	1460x250/2	KINF24	KINF23	KINF22				KINF24U	KINF23U	KINF22U
	1740x330/3	KINF27	KINF26	KINF25				KINF27U	KINF26U	KINF25U
	2200x330/3	KINF30	KINF29	KINF28				KINF30U	KINF29U	KINF28U
	2500x400/3	KINF33	KINF32	KINF31				KINF33U	KINF32U	KINF31U
		€ 121,20	€ 159,00	€ 186,90				€ 158,10	€ 202,40	€ 221,70
Videohinweis Variante A 	470x630/2	KINF36	KINF35	KINF34	KINF36F	KINF35F	KINF34F	KINF36U	KINF35U	KINF34U
	630x960/2,5	KINF39	KINF38	KINF37	KINF39F	KINF38F	KINF37F	KINF39U	KINF38U	KINF37U
		€ 85,80	€ 102,10	€ 114,50	€ 110,50	€ 119,30	€ 141,20	€ 107,90	€ 128,90	€ 143,10
Videohinweis Variante B  Hintergrund: zitronengelb	470x630/2	KINF45	KINF44	KINF43	KINF45F	KINF44F	KINF43F	KINF45U	KINF44U	KINF43U
	630x960/2,5	KINF48	KINF47	KINF46	KINF48F	KINF47F	KINF46F	KINF48U	KINF47U	KINF46U
		€ 85,80	€ 102,10	€ 114,50	€ 110,50	€ 119,30	€ 141,20	€ 107,90	€ 128,90	€ 143,10

SONSTIGE INFORMATIONSSCHILDER	MASSE/ STÄRKE MM	AUSFÜHRUNG FLACH			AUSFÜHRUNG FORMLINE			AUSFÜHRUNG ALFORM		
		Folie EGP Type 1	Folie HIP Type 2	Folie DGV Type 3	Folie EGP Type 1	Folie HIP Type 2	Folie DGV Type 3	Folie EGP Type 1	Folie HIP Type 2	Folie DGV Type 3
Videohinweis Variante C mit oder ohne rot blinkenden Solarmarker (Grundflasher)	470x150	Ausführung ohne Grundflasher			KSKV01FO			KSKV01UO		
					€ 72,40		€ 77,60			
	470x230	Ausführung mit Grundflasher			KSKV02FO			KSKV02UO		
					€ 96,20		€ 83,00			
470x150				KSKV01F			KSKV01U			
	470x230				KSKV02F			KSKV02U		
Groundflasher		KGFC01								
		€ 60,00								
Plakattafelkonstruktion	3750x2650/3	KINF52								
		€ 4.843,90								
Plane	3600x2400	KINF53								
		€ 700,00								
Haltestellenschild RAL 9016 beschichtet	380x535/3			KINF58						
				€ 150,60						
		Mindestabnahme: 25 Stk.								
Bushaltestelle	625x250/3	KINF63F								
		€ 115,00								
		doppelseitig belegt								
Wanderwegsbeschilderung	600x150	KWANDERSCHFO								
		€ 68,60								
		RAL beschichtet (1023) mit transparenter hochwertiger Folie belegt, mit 2 Bolzen an der Rückseite, passend für KCE60 Lasche								
		Mengenrabatt: ab 20 Stk. -15% Rabatt, ab 50 Stk. -25% Rabatt, ab 200 Stk. -30% Rabatt								
Schulbuswarnschild	400x400/2	KINF66								
		€ 55,80								
Magnetausf.		KINF69								
		€ 47,00								
Geländeordnungstafel	630x630/2	KINF72	KINF71	KINF70	KINF72F	KINF71F	KINF70F	KINF72U	KINF71U	KINF70U
		€ 120,40	€ 144,00	€ 153,40	€ 347,00	€ 370,50	€ 388,70	€ 185,50	€ 209,00	€ 218,40
	1000x1500/3	KINF75	KINF74	KINF73				KINF75U	KINF74U	KINF73U
		€ 378,90	€ 519,80	€ 597,30				€ 432,30	€ 565,40	€ 647,40
Baustellentafel	1000x1500/3	KINF81	KINF80	KINF79				KINF81U	KINF80U	KINF79U
		€ 378,90	€ 519,80	€ 597,30				€ 432,30	€ 565,40	€ 647,40



VERKEHRSZEICHEN

SONSTIGE INFORMATIONSSCHILDER	MASSE/ STÄRKE MM	AUSFÜHRUNG FLACH			AUSFÜHRUNG FORMLINE			AUSFÜHRUNG ALFORM		
		Folie EGP	Folie HIP	Folie DGV	Folie EGP	Folie HIP	Folie DGV	Folie EGP	Folie HIP	Folie DGV
		Type 1	Type 2	Type 3	Type 1	Type 2	Type 3	Type 1	Type 2	Type 3
Bauprojekt-Infotafel 	3500x2500/3	KINF90						KINF90U		
		€ 2.084,70						€ 2.804,20		
Ausführung im Digitaldruck, nicht reflektierend, 3 Jahre UV-Beständigkeitsgarantie										
Sondertafel Schneeräumung LKW 	1000x1500/3	K5399S09	K5399S08	K5399S07				K5399S09U	K5399S08U	K5399S07U
		€ 378,90	€ 519,80	€ 597,30				€ 432,30	€ 565,40	€ 647,40
Hintergrund: zitronengelb neongelbe Ausführung gegen Aufpreis										
Achtung Staugefahr! 	1000x1500/3	KINF84	KINF83	KINF82				KINF84U	KINF83U	KINF82U
		€ 378,90	€ 519,80	€ 597,30				€ 432,30	€ 565,40	€ 647,40
Hintergrund: zitronengelb fluoreszierende Ausführung gegen Aufpreis										
Helikoptertafel (gekantet) 	1100x600 +600/3	KRVS265R			Ausführung: Aluminium orange RAL 2002 pulverbeschichtet					
		Anfrage			Beschriftung: Scotchlcal schwarz					
	1100x600 +600/3	KRVS265RF			Ausführung: Folie Type 3 DG 4084 rotorange fluoreszierend					
		€ 1.103,90			Beschriftung: Scotchlcal schwarz					
Lawinenschild    	500x700/2	KRVSG241	KRVSG240	KRVSG239				KRVSG241U	KRVSG240U	KRVSG239U
		€ 122,10	€ 153,00	€ 179,60				€ 157,20	€ 186,10	€ 218,60
	500x1000/2	KRVSG244	KRVSG243	KRVSG242				KRVSG244U	KRVSG243U	KRVSG242U
		€ 166,20	€ 210,00	€ 233,70				€ 198,60	€ 238,50	€ 275,20
	700x500/2	KRVSG247	KRVSG246	KRVSG245				KRVSG247U	KRVSG246U	KRVSG245U
	€ 122,10	€ 153,00	€ 179,60				€ 157,20	€ 186,10	€ 218,60	
	1000x700/2,5	KRVSG250	KRVSG249	KRVSG248				KRVSG250U	KRVSG249U	KRVSG248U
		€ 217,40	€ 277,90	€ 328,40				€ 252,50	€ 307,00	€ 363,90



DIGITALDRUCK MACHT EINDRUCK.

SONSTIGE INFORMATIONSSCHILDER	MASSE/ STÄRKE MM	AUSFÜHRUNG FLACH			AUSFÜHRUNG FORMLINE			AUSFÜHRUNG ALFORM		
		Folie EGP Type 1	Folie HIP Type 2	Folie DGV Type 3	Folie EGP Type 1	Folie HIP Type 2	Folie DGV Type 3	Folie EGP Type 1	Folie HIP Type 2	Folie DGV Type 3
		Gefahrentafel Kinder 								
	470x630/2 630x470/2	KRVS267								
		€ 81,20								

Ausführungsvarianten "Gefahrentafel Kinder"

Variante A



Hintergrund: zitronengelb

Variante B



Hintergrund: zitronengelb

Variante C



Hintergrund: zitronengelb

Variante D



Hintergrund: zitronengelb

Variante F



Hintergrund: zitronengelb

Variante G



Hintergrund: zitronengelb

Variante I



Hintergrund: zitronengelb

Variante J



Hintergrund: zitronengelb

Variante K



Hintergrund: zitronengelb

Variante L



Hintergrund: zitronengelb



WIR SETZEN ZEICHEN.



Schutzbake

Aluminium, gekantetes Profil
Höhe: 1250mm, Breite: 150mm
Hochrückstrahlende Folie Type 2 HIP



Rohrdurchmesser	Best.-Nr. Preis
60-76mm	KSWBA060 € 181,70
90-110mm	KSWBA090 € 214,70
ab 110mm	KSWBAXL1 € 247,70

Vorher



Nachher

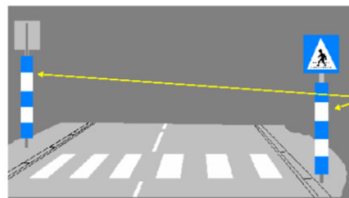
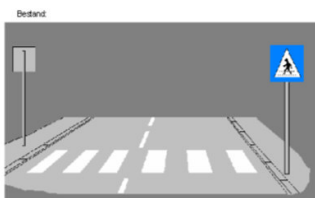

Schutzbaken
Portalfeld
Blickverengung
zum Fußgänger
bessere Sichtbarkeit



Detailpositionierung an die Örtlichkeit anpassen - siehe Vorschläge

Montageanleitung:

Beigestellte Schlauchklemme oder eigenes Stahlband durch den Schlitz führen (bei abgesetzten Stehern ist eine Distanz (Polyamid) zum Ausgleich angebracht). Schlauchklemme gemäß Montagesituation positionieren. Mit Akkuschrauber oder Handwerkzeug bei allen 3 Befestigungsmöglichkeiten bis zum Anliegen am Steher anziehen. **Auf festen Halt achten und kontrollieren!**

LED-Signal-Anlage für Schutzwege

bestehend aus:

- 2 Blitzleuchten, gelb, mit DM 100 auf schwarzem Grund
- standardmäßig mit Sensor zur Erkennung von Fußgänger
- Preis ohne Verkehrszeichen



Energiezufuhr:

1. Ausführung Feststrom:

Stromzufuhr bauseits, Feststromausführung - Netzteil 230V/12V DC

2. Ausführung Laternenstrom:

Stromzufuhr bauseits, Strassenbeleuchtungsausführung - Netzteil 230V/12V DC, Laderegler, Batterie 12V/18 Ah

3. Ausführung Solarstrom:

Solarpaneele mit Pufferbatterie bestehend aus: 20W Solarpanel mit Halterungen für Steher DM 60, Akku-Controller zur Überwachung der Batterie, Akku 12V/18 Ah



Artikel	Best.-Nr. Preis
Ausführung Feststrom	KFESTSTRLED Anfrage
Ausführung Laternenstrom	KLATERNLED Anfrage
Ausführung Solarstrom	KSOLARLED Anfrage

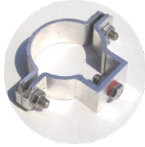

Laschen für die Befestigung von flachen Schildern (KC - Laschen)
direkte Befestigung (zum Anschrauben)

einseitige Befestigung		
AE - Lasche Bauhöhe: 27mm 	Rohr-DM in mm	Best.Nr. Preis/Stk.
	48	KAE48 € 10,00
	60	KAE60 € 10,20
	76	KAE76 € 10,40
	90	KAE90 € 10,70

beidseitige Befestigung		
AD - Lasche Bauhöhe: 27mm 	Rohr-DM in mm	Best.Nr. Preis/Stk.
	48	KAD48 € 11,40
	60	KAD60 € 11,50
	76	KAD76 € 11,90
	90	KAD90 € 12,10

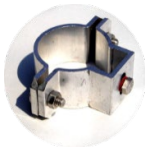
verstärkt		
BE - Lasche Bauhöhe: 40mm 	Rohr-DM in mm	Best.Nr. Preis/Stk.
	48	KBE48 € 11,20
	60	KBE60 € 11,40
	76	KBE76 € 11,50
	90	KBE90 € 12,50

verstärkt		
BD - Lasche Bauhöhe: 40mm 	Rohr-DM in mm	Best.Nr. Preis/Stk.
	48	KBD48 € 12,80
	60	KBD60 € 12,90
	76	KBD76 € 13,90
	90	KBD90 € 14,40

für höhere Wind- und Schneelasten		
CE - Lasche Bauhöhe: 27mm 	Rohr-DM in mm	Best.Nr. Preis/Stk.
	60	KCE60 € 14,90
	76	KCE76 € 15,00
	90	KCE90 € 15,80

für höhere Wind- und Schneelasten		
CD - Lasche Bauhöhe: 27mm 	Rohr-DM in mm	Best.Nr. Preis/Stk.
	60	KCD60 € 19,10
	76	KCD76 € 19,50
	90	KCD90 € 20,30

verstärkt für besonders hohe Wind- und Schneelasten		
DE - Lasche Bauhöhe: 40mm 	Rohr-DM in mm	Best.Nr. Preis/Stk.
	60	KDE60 € 16,30
	76	KDE76 € 16,70
	90	KDE90 € 17,60

verstärkt für besonders hohe Wind- und Schneelasten		
DD - Lasche Bauhöhe: 40mm 	Rohr-DM in mm	Best.Nr. Preis/Stk.
	60	KDD60 € 21,60
	76	KDD76 € 21,90
	90	KDD90 € 22,70

Bandbefestigung	
AB - Lasche Bauhöhe: 27mm 	Best.Nr. Preis/Stk. KAB00 € 10,20

Bandbefestigung verstärkt	
BB - Lasche Bauhöhe: 40mm 	Best.Nr. Preis/Stk. KBB00 € 11,50

Sonderlasche für Wanderwegsbeschilderung		
Lochabstand: 350mm Lieferung ohne Schrauben 	Rohr-DM in mm	Best.Nr. Preis/Stk.
	60	KSCHELLWW Anfrage

LASCHEN

LASCHEN FÜR FLACHE SCHILDER

Laschen für die Befestigung von flachen Schildern (KC - Laschen) mittels Klemmung

AE-KC Lasche (für die einseitige Montage)	Rohr-DM in mm	150	250	310	380	440	470	620	750	960
		Bauhöhe: 27mm	48	KAE48KC15 € 17,20	KAE48KC25 € 18,30	KAE48KC31 € 18,50	KAE48KC38 € 19,50	KAE48KC44 € 20,30	KAE48KC47 € 22,60	KAE48KC62 € 24,80
	60	KAE60KC15 € 17,60	KAE60KC25 € 18,30	KAE60KC31 € 19,00	KAE60KC38 € 19,50	KAE60KC44 € 20,30	KAE60KC47 € 22,70	KAE60KC62 € 24,70	KAE60KC75 € 27,80	KAE60KC96 € 29,50
	76	KAE76KC15 € 17,70	KAE76KC25 € 18,50	KAE76KC31 € 19,10	KAE76KC38 € 20,10	KAE76KC44 € 20,80	KAE76KC47 € 22,70	KAE76KC62 € 25,00	KAE76KC75 € 28,00	KAE76KC96 € 29,70
	90	KAE90KC15 € 18,20	KAE90KC25 € 19,10	KAE90KC31 € 20,10	KAE90KC38 € 20,80	KAE90KC44 € 21,50	KAE90KC47 € 23,30	KAE90KC62 € 26,00	KAE90KC75 € 28,20	KAE90KC96 € 30,40

AD-KC Lasche (für die beidseitige Montage)	Rohr-DM in mm	150	250	310	380	440	470	620	750	960
		Bauhöhe: 27mm	48	KAD48KC15 € 24,40	KAD48KC25 € 26,30	KAD48KC31 € 27,70	KAD48KC38 € 28,80	KAD48KC44 € 29,70	KAD48KC47 € 34,40	KAD48KC62 € 39,40
	60	KAD60KC15 € 24,40	KAD60KC25 € 26,50	KAD60KC31 € 27,70	KAD60KC38 € 28,90	KAD60KC44 € 30,20	KAD60KC47 € 34,40	KAD60KC62 € 39,40	KAD60KC75 € 44,00	KAD60KC96 € 48,30
	76	KAD76KC15 € 24,50	KAD76KC25 € 26,70	KAD76KC31 € 27,80	KAD76KC38 € 29,40	KAD76KC44 € 30,40	KAD76KC47 € 34,70	KAD76KC62 € 39,70	KAD76KC75 € 44,50	KAD76KC96 € 48,40
	90	KAD90KC15 € 25,00	KAD90KC25 € 27,40	KAD90KC31 € 28,20	KAD90KC38 € 29,50	KAD90KC44 € 30,70	KAD90KC47 € 35,00	KAD90KC62 € 40,10	KAD90KC75 € 45,10	KAD90KC96 € 48,70

BE-KC Lasche (für die einseitige Montage)	Rohr-DM in mm	150	250	310	380	440	470	620	750	960
		Verstärkt, für höhere Wind- und Schneelasten Bauhöhe: 40mm	48	KBE48KC15 € 17,60	KBE48KC25 € 19,50	KBE48KC31 € 20,30	KBE48KC38 € 21,20	KBE48KC44 € 21,90	KBE48KC47 € 23,70	KBE48KC62 € 26,30
	60	KBE60KC15 € 17,70	KBE60KC25 € 20,10	KBE60KC31 € 20,80	KBE60KC38 € 21,50	KBE60KC44 € 21,90	KBE60KC47 € 23,90	KBE60KC62 € 26,50	KBE60KC75 € 29,40	KBE60KC96 € 30,80
	76	KBE76KC15 € 18,20	KBE76KC25 € 20,30	KBE76KC31 € 21,20	KBE76KC38 € 21,60	KBE76KC44 € 22,60	KBE76KC47 € 24,40	KBE76KC62 € 26,70	KBE76KC75 € 29,50	KBE76KC96 € 31,20
	90	KBE90KC15 € 18,50	KBE90KC25 € 21,50	KBE90KC31 € 21,90	KBE90KC38 € 22,60	KBE90KC44 € 23,20	KBE90KC47 € 24,70	KBE90KC62 € 27,80	KBE90KC75 € 30,20	KBE90KC96 € 32,20

BD-KC Lasche (für die beidseitige Montage)	Rohr-DM in mm	150	250	310	380	440	470	620	750	960
		Verstärkt, für höhere Wind- und Schneelasten Bauhöhe: 40mm	48		KBD48KC25 € 27,70	KBD48KC31 € 28,80	KBD48KC38 € 29,70	KBD48KC44 € 30,80	KBD48KC47 € 35,60	KBD48KC62 € 40,60
	60	KBD60KC15 € 26,00	KBD60KC25 € 27,80	KBD60KC31 € 28,90	KBD60KC38 € 30,20	KBD60KC44 € 31,20	KBD60KC47 € 35,70	KBD60KC62 € 40,90	KBD60KC75 € 45,70	KBD60KC96 € 49,30
	76	KBD76KC15 € 26,30	KBD76KC25 € 28,00	KBD76KC31 € 29,40	KBD76KC38 € 0,00	KBD76KC44 € 31,50	KBD76KC47 € 36,00	KBD76KC62 € 41,10	KBD76KC75 € 45,90	KBD76KC96 € 49,50
	90			KBD90KC31 € 29,70	KBD90KC38 € 0,00	KBD90KC44 € 32,30	KBD90KC47 € 36,40	KBD90KC62 € 41,70	KBD90KC75 € 47,00	KBD90KC96 € 50,10

CE-KC Lasche (für die einseitige Montage)	Rohr-DM in mm	150	250	310	380	440	470	620	750	960
		Verstärkt, für hohe Wind- und Schneelasten Bauhöhe: 27mm	60		KCE60KC25 € 21,90	KCE60KC31 € 22,60	KCE60KC38 € 23,20	KCE60KC44 € 23,40	KCE60KC47 € 25,20	KCE60KC62 € 28,20
	76		KCE76KC25 € 22,20	KCE76KC31 € 22,70	KCE76KC38 € 23,30	KCE76KC44 € 23,70	KCE76KC47 € 26,00	KCE76KC62 € 28,80	KCE76KC75 € 30,80	KCE76KC96 € 33,00
	90		KCE90KC25 € 22,70	KCE90KC31 € 23,30	KCE90KC38 € 23,70	KCE90KC44 € 24,40	KCE90KC47 € 26,50	KCE90KC62 € 29,40	KCE90KC75 € 31,50	KCE90KC96 € 33,70

LASCHEN

LASCHEN FÜR FLACHE SCHILDER

CD-KC Lasche (für die beidseitige Montage)		Rohr-DM in mm	150	250	310	380	440	470	620	750	960
Verstärkt, für hohe Wind- und Schneelasten Bauhöhe: 27mm 	60			KCD60KC25 € 32,70	KCD60KC31 € 33,70	KCD60KC38 € 35,00	KCD60KC44 € 36,20	KCD60KC47 € 40,60	KCD60KC62 € 45,30	KCD60KC75 € 50,10	KCD60KC96 € 54,30
	76			KCD76KC25 € 33,00	KCD76KC31 € 34,00	KCD76KC38 € 35,60	KCD76KC44 € 36,40	KCD76KC47 € 41,70	KCD76KC62 € 45,70	KCD76KC75 € 50,90	KCD76KC96 € 54,50
	90			KCD90KC25 € 33,70	KCD90KC31 € 34,90	KCD90KC38 € 36,00	KCD90KC44 € 36,80	KCD90KC47 € 42,10	KCD90KC62 € 47,00	KCD90KC75 € 51,60	KCD90KC96 € 55,20

DE-KC Lasche (für die einseitige Montage)		Rohr-DM in mm	150	250	310	380	440	470	620	750	960
Verstärkt, für besonders hohe Wind- und Schneelasten Bauhöhe: 40mm 	60			KDE60KC25 € 23,40	KDE60KC31 € 23,70	KDE60KC38 € 24,50	KDE60KC44 € 25,00	KDE60KC47 € 27,70	KDE60KC62 € 30,20	KDE60KC75 € 32,30	KDE60KC96 € 34,40
	76			KDE76KC25 € 23,70	KDE76KC31 € 24,40	KDE76KC38 € 24,70	KDE76KC44 € 25,20	KDE76KC47 € 27,80	KDE76KC62 € 30,40	KDE76KC75 € 32,70	KDE76KC96 € 34,90
	90			KDE90KC25 € 24,50	KDE90KC31 € 25,00	KDE90KC38 € 26,00	KDE90KC44 € 26,50	KDE90KC47 € 28,80	KDE90KC62 € 31,20	KDE90KC75 € 33,70	KDE90KC96 € 35,70

DD-KC Lasche (für die beidseitige Montage)		Rohr-DM in mm	150	250	310	380	440	470	620	750	960
Verstärkt, für besonders hohe Wind- und Schneelasten Bauhöhe: 40mm 	60			KDD60KC25 € 34,90	KDD60KC31 € 35,70	KDD60KC38 € 36,80	KDD60KC44 € 38,40	KDD60KC47 € 43,30	KDD60KC62 € 47,10	KDD60KC75 € 52,60	KDD60KC96 € 56,30
	76			KDD76KC25 € 35,00	KDD76KC31 € 36,20	KDD76KC38 € 37,60	KDD76KC44 € 38,50	KDD76KC47 € 43,60	KDD76KC62 € 48,30	KDD76KC75 € 52,80	KDD76KC96 € 56,70
	90			KDD90KC25 € 36,00	KDD90KC31 € 36,80	KDD90KC38 € 38,40	KDD90KC44 € 39,70	KDD90KC47 € 44,50	KDD90KC62 € 49,00	KDD90KC75 € 54,20	KDD90KC96 € 57,60

AB-KC Laschen (für die Bandbefestigung)		Rohr-DM in mm	150	250	310	380	440	470	620	750	960
Bauhöhe: 27 mm 	Bandbef.			KAB00KC25 € 17,70	KAB00KC31 € 18,30	KAB00KC38 € 19,00	KAB00KC44 € 19,50	KAB00KC47 € 22,20	KAB00KC62 € 24,40	KAB00KC75 € 27,40	KAB00KC96 € 28,90

Klemmteil Kunststoff-Teil	Artikel	Best.Nr. Preis/Stk.
	Klemmteil	KAE00 € 4,50

DIGITALDRUCK MACHT EINDRUCK.



ITEK



Sonderlaschen für Masten passend zu KC Laschen

einseitige Befestigung		
EE - Lasche	Rohr-DM in mm	Best.Nr. Preis/Stk.
	100	KAE100 € 43,50
	110	KAE110 € 43,70
	120	KAE120 € 45,80
	130	KAE130 € 46,00
	140	KAE140 € 48,00
	150	KAE150 € 49,10
	160	KAE160 € 49,30

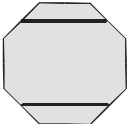
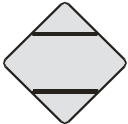
beidseitige Befestigung		
ED - Lasche	Rohr-DM in mm	Best.Nr. Preis/Stk.
	100	KAD100 € 56,20
	110	KAD110 € 56,60
	120	KAD120 € 57,50
	130	KAD130 € 58,80
	140	KAD140 € 61,40
	150	KAD150 € 62,00
	160	KAD160 € 62,00

KC Laschen Anwendungsempfehlung

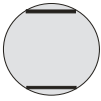
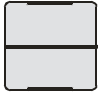
Formate	Größen	oben	mitte	unten
Gefahrenzeichen 	700	KC 15		KC 44
	1000	KC 25		KC 62
	1500	KC 31	KC 75	KC 96
Halt 	630x630	KC 44		KC 44
	940x940	KC 62		KC 62
	1160x1160	KC 96		KC 96
Vorrangstraße 	470x470	KC 25		KC 25
	630x630	KC 44		KC 44
	960x960	KC 62	KC 96	KC 62
Zusatztafeln 	310x150	KC 15		KC 15
	400x150	KC 25		KC 25
	480x150	KC 25		KC 25
	960x960	KC 62		KC 62
Leitbaken Bahnabaken 	250x1000	KC 15	KC 25	KC 15
	310x630	KC 15	KC 31	KC 15
	310x960	KC 15	KC 31	KC 15
	310x1150	KC 15	KC 31	KC 15
	380x1200	KC 25	KC 38	KC 25

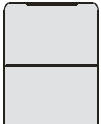
Formate	Größen	oben	mitte	unten
Verbots- u. Gebotszeichen 	480	KC 25		KC 25
	670	KC 44		KC 44
	960	KC 62		KC 62
	1200	KC 96		KC 96
Hinweiszeichen und Quadrate 	310x310	KC 15		KC 15
	470x470	KC 25		KC 25
	630x630	KC 44		KC 44
	960x960	KC 62	KC 96	KC 62
Hinweiszeichen 	470x630	KC 25		KC 25
	630x960	KC 44	KC 62	KC 44
	960x1200	KC 75	KC 96	KC 75
Wegweiser / Einbahn 	960x310	KC 62		KC 62
	1150x310	KC 62		KC 62
	1460x310	KC 96		KC 96
Leitwinkel 	470x700	KC 25	KC 47	KC 25
	600x900	KC 44	KC 90 Sonderlasche	KC 44





LASCHEN

LASCHEN FÜR ALFORM-SCHILDER

Laschen für die Befestigung von Alform-Schildern (U-Laschen)

einseitige Befestigung		
AEU - Lasche Bauhöhe: 27mm 	Rohr-DM in mm	Best.Nr. Preis/Stk.
	48	KAE48U Anfrage
	60	KAE60U € 11,20
	76	KAE76U € 11,50
	90	KAE90U € 12,50

beidseitige Befestigung		
ADU - Lasche Bauhöhe: 27mm 	Rohr-DM in mm	Best.Nr. Preis/Stk.
	48	KAD48U Anfrage
	60	KAD60U € 15,70
	76	KAD76U € 16,30
	90	KAD90U € 16,90

für höhere Wind- und Schneelasten		
BEU - Lasche Bauhöhe: 27mm 	Rohr-DM in mm	Best.Nr. Preis/Stk.
	60	KBE60U € 16,20
	76	KBE76U € 16,30
	90	KBE90U € 16,90

verstärkt		
BDU - Lasche Bauhöhe: 27mm 	Rohr-DM in mm	Best.Nr. Preis/Stk.
	60	KBD60U € 21,60
	76	KBD76U € 21,90
	90	KBD90U € 22,60

für hohe Wind- und Schneelasten		
CEU - Lasche Bauhöhe: 40mm 	Rohr-DM in mm	Best.Nr. Preis/Stk.
	60	KCE60U € 17,70
	76	KCE76U € 18,20
	90	KCE90U € 19,00

für höhere Wind- und Schneelasten		
CDU - Lasche Bauhöhe: 40mm 	Rohr-DM in mm	Best.Nr. Preis/Stk.
	60	KCD60U € 22,70
	76	KCD76U € 23,30
	90	KCD90U € 23,90

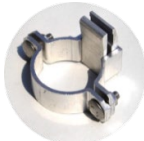
verstärkt für besonders hohe Wind- und Schneelasten		
DEU - Lasche Bauhöhe: 27mm 	Rohr-DM in mm	Best.Nr. Preis/Stk.
	48	KDE48UB € 10,70
	60	KDE60UB € 10,90
	76	KDE76UB € 11,60
	90	KDE90UB € 12,20

verstärkt für besonders hohe Wind- und Schneelasten		
DDU - Lasche Bauhöhe: 27mm 	Rohr-DM in mm	Best.Nr. Preis/Stk.
	48	KDD48UB € 16,00
	60	KDD60UB € 16,10
	76	KDD76UB € 16,90
	90	KDD90UB € 18,60

Bandbefestigung	
ABU - Lasche Bauhöhe: 27mm 	Best.Nr. Preis/Stk. KAB00U € 11,50

Bandbefestigung verstärkt	
BBU - Lasche Bauhöhe: 40mm 	Best.Nr. Preis/Stk. KBB00U € 12,90

Wandbefestigung	
AWU - Lasche Bauhöhe: 27mm 	Best.Nr. Preis/Stk. KAW00U € 18,20

SL-Lasche für Profilsteher		
SL - Lasche  	Ausführung	Best.Nr. Preis/Stk.
	Ausf. A	KS00LA € 11,50
	Ausf. B	KS00LB € 13,90

Klemmteil AU	
	Best.Nr. Preis/Stk. KAO0U € 4,30

LASCHEN

LASCHEN FÜR FORMLINE-SCHILDER, ZUBEHÖR FÜR BANDBEFESTIGUNG

Laschen für die Befestigung von Formline-Schildern / C-Profil (F-Laschen)

einseitige Befestigung		
AEF - Lasche 27mm 	Rohr-DM in mm	Best.Nr. Preis/Stk.
	48	KAE48F Anfrage
	60	KAE60F € 10,70
	76	KAE76F € 10,70
	90	KAE90F € 11,40

beidseitige Befestigung		
ADF - Lasche 27mm 	Rohr-DM in mm	Best.Nr. Preis/Stk.
	48	KAD48F Anfrage
	60	KAD60F € 15,50
	76	KAD76F € 16,20
	90	KAD90F € 16,70

für höhere Wind- und Schneelasten		
BEF - Lasche 27mm 	Rohr-DM in mm	Best.Nr. Preis/Stk.
	60	KBE60F € 15,00
	76	KBE76F € 15,50
	90	KBE90F € 15,80

für höhere Wind- und Schneelasten		
BDF - Lasche 27mm 	Rohr-DM in mm	Best.Nr. Preis/Stk.
	60	KBD60F € 20,30
	76	KBD76F € 20,80
	90	KBD90F € 21,60

Bandbefestigung	
ABF - Lasche 27mm 	Best.Nr. Preis/Stk. KAB00F € 11,20

Bandbefestigung verstärkt	
BBF - Lasche 40mm 	Best.Nr. Preis/Stk. KBB00F € 12,80

Wandbefestigung	
AWF - Lasche 27mm 	Best.Nr. Preis/Stk. KAW00F € 17,70

Klemmteil AF	
	Best.Nr. Preis/Stk. KA00F € 4,50

Zubehör für Bandbefestigung

Montagewerkzeug	
	Best.Nr. Preis/Stk. KS001 Anfrage

Spannschloss	
	Best.Nr. Preis/Stk.
	1/2" KSO02A Anfrage
	3/4" KSO02 € 11,00

Schlaufen aus rostfreiem Stahl		Artikel	Best.Nr. Preis/Stk.
	1/2"	KS003 € 0,60	
	3/4"	KS004 € 0,80	

Stahlband		Artikel	Best.Nr. Preis/Stk.
Stärke: 0,7 mm, aus rostfreiem Stahl 1/2" Zugfestigkeit: 700kg 3/4" Zugfestigkeit: 1000kg 	1/2" / 30lfm	KS005 € 79,00	
	1/2" / per lfm.	KS007 € 9,60	
	3/4" / 30lfm	KS006 € 100,00	
	3/4" / per lfm.	KS008 € 10,20	



STEHER

Bemessung der Steher

Bemessung von Steher - Aluminium

Bei Güteverkehrszeichen, den zugehörigen Befestigungen und Stehern ist durch Prüfung und Berechnung nachgewiesen, dass die statischen Anforderungen der RVS 05.02.11 und der ÖNORM 12899-1 erfüllt sind.

Diagramm I für Aluminium-Steher (AlMgSi 0,5 F25)

Bemessung der Steher bis 4m² Fläche
Windlastbemessung lt. RVS 08.23.01
und EN 12899-1, Windlastklasse 3 für
Verkehrszeichen
Bei Verwendung von 2 Stehern ist die
doppelte Fläche zulässig.

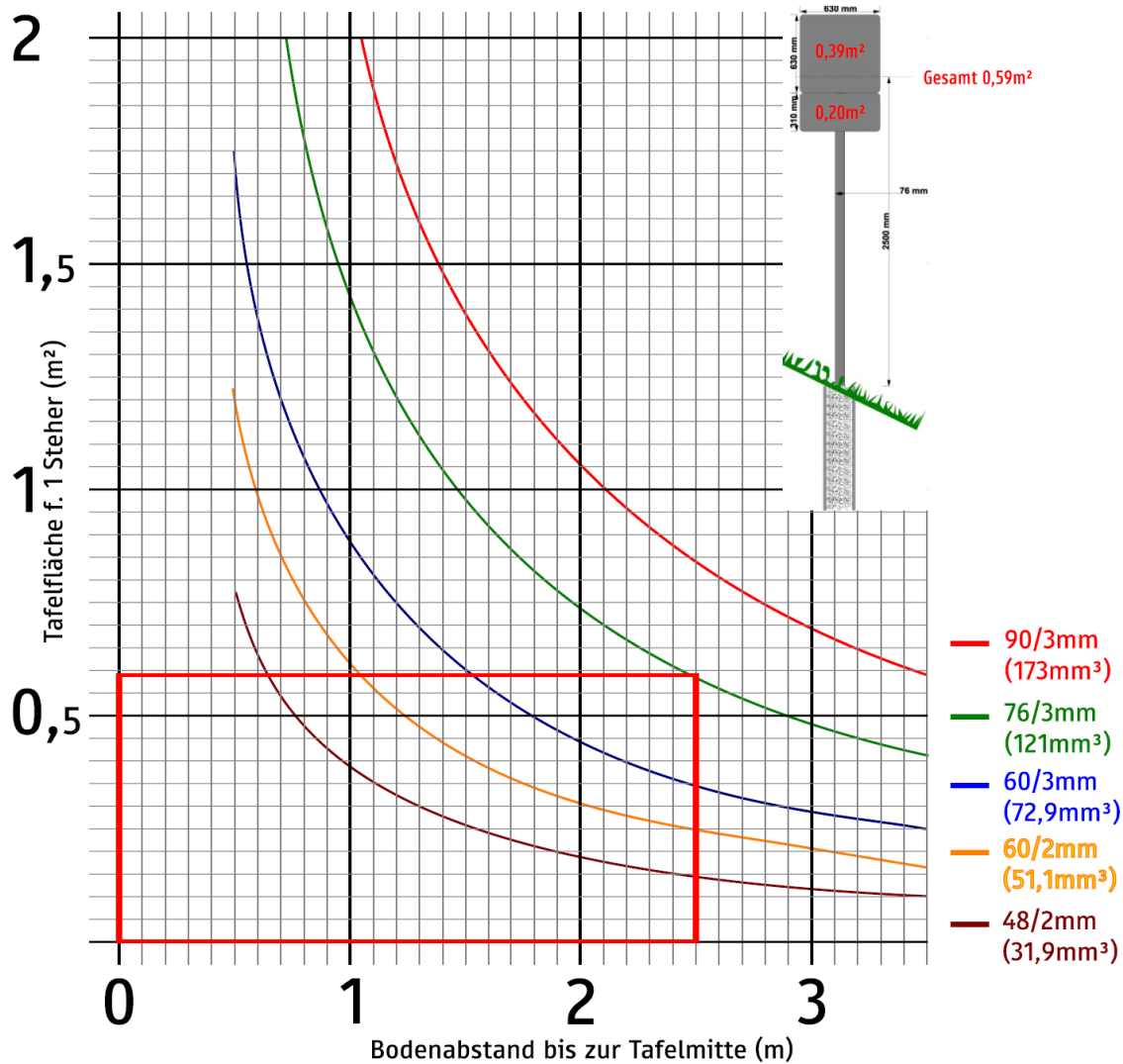

Bemessung von Steher - verzinkt

Bei Güteverkehrszeichen, den zugehörigen Befestigungen und Stehern ist durch Prüfung und Berechnung nachgewiesen, dass die statischen Anforderungen der RVS 05.02.11 und der ÖNORM 12899-1 erfüllt sind.

Diagramm II für Stahlrohre (ST 37-2)

Bemessung der Steher bis 4m² Fläche
Windlastbemessung lt. RVS 08.23.01
und EN 12899-1, Windlastklasse 3 für
Verkehrszeichen
Bei Verwendung von 2 Stehern ist die
doppelte Fläche zulässig.

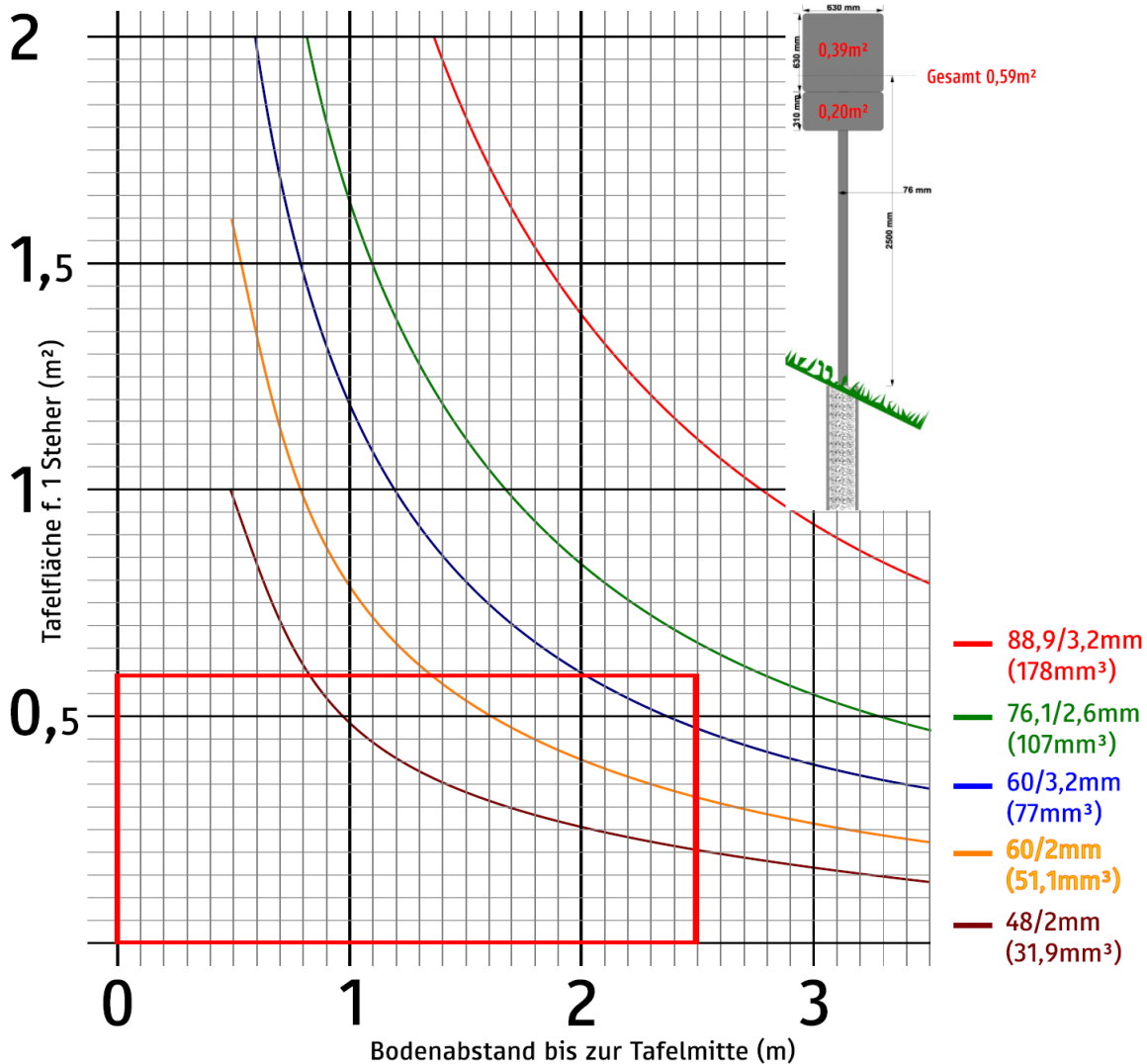

Bemessung von I-Steher

Bei Güterverkehrszeichen, den zugehörigen Befestigungen und Stehern ist durch Prüfung und Berechnung nachgewiesen, dass die statischen Anforderungen der RVS 05.02.11 und der ÖNORM 12899-1 erfüllt sind.

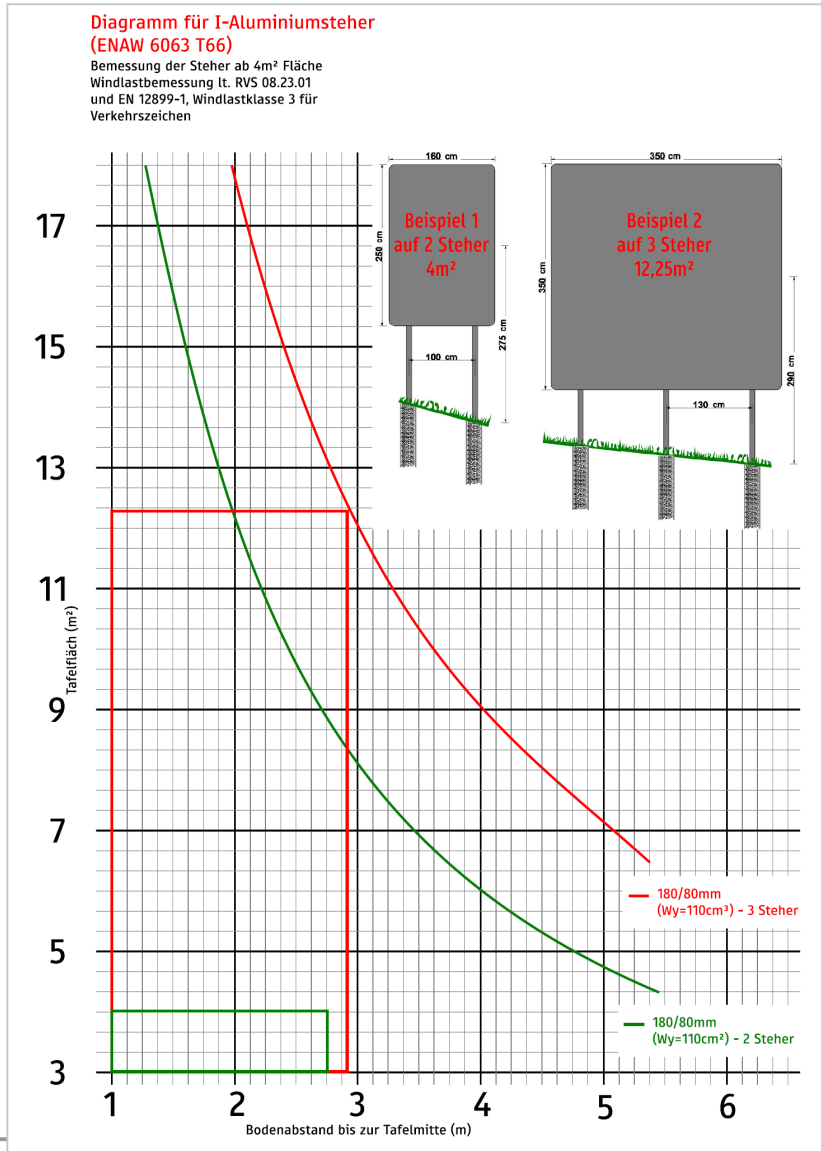

Bemessungs- und Konstruktionserfordernisse:

Die Bemessung der Verkehrszeichen, Verkehrszeichenträger und Befestigungselemente ist entsprechend ihrem Eigengewicht sowie der Wind- und Schneedruckbelastung durchzuführen. Als Summe der horizontalen Belastungen ist im allgemeinen ein Wert von 960 N/m² anzunehmen. Konstruktionen und Tafeln mit mehr als 6,0 m Höhe sind gemäß ÖNORM B 4014 zu bemessen. (Auszug aus der RVS 05.02.11, Pkt. 2.3; im Zusammenhang mit Erlass des Bundesministeriums für wirtschaftliche Angelegenheiten, Zl. 801. 105/2 - VI/1/88, für die Bundesstraßenverwaltung verbindlich, dies betrifft nunmehr Bundesstraßen, A und S). Bei der Bemessung gemäß obenstehender Diagramme sind auch die Erfordernisse der RVS 05.02.11 erfüllt.

KÄRNTEN Anbringung von Verkehrszeichen

Ortsgebiet: 0,3 – 2m
 Freiland: 1,0 – 2,5m

0,6 – 2,5m
 4,5m – 5,5m
 3,4m

Fahrbahn

Autobahnen: 250m-450m
 Freiland: 150m-250m

Freiland: max 20m
 Ortsgebiet: max 10m

Freiland: max 50m
 Ortsgebiet: max 20m

Geschäftsadresse:
 9131 Grafenstein
 St. Peter 33

ITEK
 ...weil Qualität zählt

KÄRNTEN
 voraus

Verkehrszeichen und Leitplanken		Mindestbodenabstand		
Tafelformat	Abmessungen [mm]	1 Steher [m]	2 Steher [m]	Rohrrahmen [m]
	700	1,5	---	1,0
	1000	1,5	---	1,0
	1500	1,5	---	1,0
	310 x 960	0,6	---	---
	380 x 1200	0,6	---	---
	310	1,5	---	---
	480	1,5	---	---
	670	1,5	---	1,0
	960	1,5	---	1,0
	1200	---	1,5	1,0
	630 x 630	1,5	---	1,0
	940 x 940	1,5	---	1,0
	1160 x 1160	---	1,5	1,0
	470 x 470	1,5	---	---
	630 x 630	1,5	---	---
	960 x 960	1,0	---	---
	310 x 310	1,5	---	---
	470 x 470	1,5	---	---
	630 x 630	1,5	---	1,0
	960 x 960	1,5	---	1,0
	1000 x 1000	---	1,5	1,0
	1500 x 1500	---	1,5	---
	2000 x 2000	---	1,5	---
	2500 x 2500	---	1,5	---
	3000 x 3000	---	1,5	---
	3500 x 3500	---	1,5	---
	4000 x 4000	---	1,5	---
	470 x 630	1,5	---	---
	630 x 960	1,5	---	---
	960 x 1200	1,5	1,5	1,0
	1000 x 1500	---	1,5	1,0
	1000 x 2000	---	1,5	1,0
	1000 x 2500	---	1,5	---
	1300 x 2000	---	1,5	---
	1500 x 2000	---	1,5	---
	1500 x 2500	---	1,5	---
	2000 x 2500	---	1,5	---
	2000 x 3000	---	1,5	---
	2500 x 3000	---	1,5	---
	2500 x 3500	---	1,5	---
	2500 x 4000	---	1,5	---
	3000 x 4000	---	1,5	---
	3500 x 4500	---	1,5	---
	3500 x 5000	---	1,5	---
	4000 x 4500	---	1,5	---
	4000 x 5000	---	1,5	---
		310 x 150	1,5	---
400 x 150		1,5	---	---
470 x 150		1,5	---	---
470 x 230		1,5	---	---
470 x 310		1,5	---	---
630 x 230		1,5	---	---
630 x 310		1,5	---	---
630 x 470		1,5	---	---
960 x 310		1,5	---	---
960 x 470		1,5	---	---
960 x 630		1,5	1,5	1,0
1000 x 310		---	1,5	---
1200 x 600		---	1,5	---
1500 x 310		---	1,5	---
1500 x 1000		---	1,5	---
1800 x 900		---	1,5	---
2000 x 1000		---	1,5	---
2000 x 1500		---	1,5	---
2500 x 1500		---	1,5	---
2500 x 2000		---	1,5	---
3000 x 1000		---	1,5	---
3000 x 1500		---	1,5	---
3000 x 2000		---	1,5	---
3000 x 2500		---	1,5	---
3500 x 5000		---	1,5	---
3500 x 1500		---	1,5	---
3500 x 2000		---	1,5	---
3500 x 2500		---	1,5	---
3500 x 3000		---	1,5	---
4000 x 2000		---	1,5	---
4000 x 3000		---	1,5	---
4000 x 3500		---	1,5	---

Verkehrszeichen und Leitplanken		Mindestbodenabstand		
Tafelformat	Abmessungen [mm]	1 Steher [m]	2 Steher [m]	Rohrrahmen [m]
	1150 x 250	1,0	1,0	1,0
	1150 x 400	1,0	1,0	1,0
	1150 x 620	1,0	1,0	1,0
	1460 x 250	1,0	1,0	1,0
	1460 x 330	---	1,0	1,0
	1460 x 400	---	1,0	1,0
	1460 x 500	---	1,0	1,0
	1460 x 620	---	1,0	1,0
	1460 x 660	---	1,0	1,0
	1740 x 330	---	1,0	1,0
	1740 x 500	---	1,0	1,0
	1740 x 660	---	1,0	1,0
	1740 x 750	---	1,0	1,0
	2200 x 330	---	1,0	1,0
	2200 x 400	---	1,0	1,0
	2200 x 500	---	1,0	1,0
2200 x 660	---	1,0	1,0	
2200 x 750	---	1,0	1,0	
2200 x 900	---	1,0	1,0	
2500 x 400	---	1,0	1,0	
2500 x 660	---	1,0	1,0	
2500 x 900	---	1,0	1,0	
	1150 x 310	0,8	0,8	0,8
	2200 x 470	0,8	0,8	0,8
	2500 x 620	---	0,8	0,8
	470 x 700	0,8	---	---
	600 x 900	0,8	---	---
	800 x 1200	0,8	0,8	---
	1000 x 1500	0,8	0,8	---
	250 x 630	0,3	---	---
	250 x 1000	0,3	---	---
	310 x 1250	0,3	---	---
	480	1,5	---	1,0
	670	1,2	---	1,0
	960	1,0	---	1,0
	960 x 630	1,5	1,2	1,0
	1500 x 1000	---	1,2	1,0
	2000 x 1000	---	1,0	1,0



STEHER

Rohrsteher, Zubehör und Fundamente

Rohrsteher verzinkt und Aluminium

Rohrsteher aus Stahl feuerverzinkt oder Aluminium
inkl. Abdeckkappe

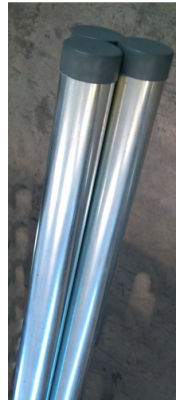

Aufstellungsempfehlung:

- fix:
- einbetonieren oder in Betonrohr einkiesen
- austauschbar:
- Steherverlängerung
- Fundamentsockel
- Bodenhülsen

innen und aussen feuerverzinkt

Länge	DM 48mm	DM 60mm	DM 60mm	DM 76mm	DM 90mm	DM 110mm
	2,0mm WS	2,0mm WS	3,0mm WS	3,0mm WS	3,0mm WS	3,0mm WS
500	KRS01V	KRS02V	KRS03V	KRS04V	KRS05V	KRS06V
	Anfrage	Anfrage	Anfrage	Anfrage	Anfrage	Anfrage
1000	KRS11V	KRS12V	KRS13V	KRS14V	KRS15V	KRS16V
	Anfrage	Anfrage	Anfrage	Anfrage	Anfrage	Anfrage
1500	KRS21V	KRS22V	KRS23V	KRS24V	KRS25V	KRS26V
	€ 29,10	€ 30,60	€ 47,50	€ 51,20	Anfrage	Anfrage
2000	KRS31V	KRS32V	KRS33V	KRS34V	KRS35V	KRS36V
	€ 35,10	€ 38,00	€ 59,70	€ 64,50	€ 82,90	Anfrage
2500	KRS41V	KRS42V	KRS43V	KRS44V	KRS45V	KRS46V
	€ 42,60	€ 46,80	€ 74,30	€ 77,80	€ 100,60	Anfrage
3000	KRS51V	KRS52V	KRS53V	KRS54V	KRS55V	KRS56V
	€ 48,80	€ 54,40	€ 86,90	€ 91,10	€ 118,40	Anfrage
3500	KRS61V	KRS62V	KRS63V	KRS64V	KRS65V	KRS66V
	€ 55,10	€ 62,00	€ 99,50	€ 104,40	€ 136,10	Anfrage
4000	KRS71V	KRS72V	KRS73V	KRS74V	KRS75V	KRS76V
	€ 61,30	€ 72,50	€ 112,10	€ 117,60	€ 153,80	Anfrage

Aufpreis: Verdrehsicherung für Alu- oder verzinkte Steher:
KVDS
€ 2,30

Aluminium AlMgSi 0,5 F25

Länge	DM 48mm	DM 60mm	DM 60mm	DM 76mm	DM 90mm	DM 110mm
	2,0mm WS	2,0mm WS	3,0mm WS	3,0mm WS	3,0mm WS	4,0mm WS
500	KRS01A	KRS02A	KRS03A	KRS04A	KRS05A	KRS06A
	Anfrage	Anfrage	Anfrage	Anfrage	Anfrage	Anfrage
1000	KRS11A	KRS12A	KRS13A	KRS14A	KRS15A	KRS16A
	Anfrage	Anfrage	Anfrage	Anfrage	Anfrage	Anfrage
1500	KRS21A	KRS22A	KRS23A	KRS24A	KRS25A	KRS26A
	€ 27,60	€ 30,60	€ 40,30	€ 49,60	Anfrage	Anfrage
2000	KRS31A	KRS32A	KRS33A	KRS34A	KRS35A	KRS36A
	€ 33,10	€ 37,10	€ 50,00	€ 62,30	€ 72,30	Anfrage
2500	KRS41A	KRS42A	KRS43A	KRS44A	KRS45A	KRS46A
	€ 39,90	€ 45,20	€ 61,80	€ 75,00	€ 87,40	Anfrage
3000	KRS51A	KRS52A	KRS53A	KRS54A	KRS55A	KRS56A
	€ 45,60	€ 51,90	€ 71,90	€ 87,80	€ 102,40	Anfrage
3500	KRS61A	KRS62A	KRS63A	KRS64A	KRS65A	KRS66A
	€ 51,30	€ 58,70	€ 82,00	€ 100,50	€ 117,50	Anfrage
4000	KRS71A	KRS72A	KRS73A	KRS74A	KRS75A	KRS76A
	€ 57,10	€ 65,50	€ 92,10	€ 113,20	€ 132,50	Anfrage

**Alu - Rohrsteher
mit Schlitzen für Bodenhülsen**



Länge	DM 60mm	DM 76mm
	3,0mm WS	3,0mm WS
1500	KRS27A	KRS28A
	€ 65,80	€ 76,00
2000	KRS37A	KRS38A
	€ 75,50	€ 88,70
2500	KRS47A	KRS48A
	€ 88,20	€ 75,00
3000	KRS57A	KRS58A
	€ 98,30	€ 114,20
3500	KRS67A	KRS68A
	€ 108,40	€ 126,90
4000	KRS77A	KRS78A
	€ 118,50	€ 139,60

Zubehör und Fundamente

Abdeckkappe

aus Kunststoff



DM	Best.-Nr. Preis
48	KRS09 € 2,30
	KRS19 € 2,80
76	KRS29 € 3,60
90	KRS49 € 4,40

Fundamentsockel Beton

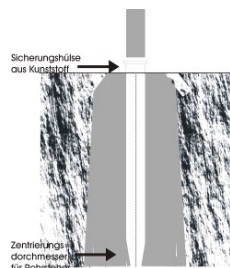

Ausführung DM / Länge / kg	Einschub- tiefe in mm	Sockelfuß in mm	Best.-Nr. Preis
48 / 500 / 25	400	240	KFU01B € 62,70
60 / 500 / 25	400	240	KFU02B € 66,10
60 / 690 / 34	600	240	KFU03B € 69,90
76 / 700 / 60	600	280	KFU04B € 131,90

Sicherungshülsen



DM 48



DM 60



DM 76

DM 48	KFU01S € 8,60
DM 60	KFU02S € 8,60
DM 76 - Teil 1 (schwarz)	KFU03S € 8,60
DM 76 - Teil 2 (weiss)	KFU03S2 € 6,60

Betonrohr



Ausführung DM / Länge	Best.-Nr. Preis
150 / 1000	KFU11B € 52,50
200 / 1000	KFU12B € 58,10
250 / 1000	KFU13B € 61,70
300 / 1000	KFU14B € 57,20

Erddorn

verzinkt, zur einfachen und schnellen Montage von Verkehrszeichen auf Rohrsteinern DM 48 oder DM 60



Ausführung DM / Länge	Best.-Nr. Preis
DM 48 (mit Sechskantschrauben)	KERDD48 € 133,40
DM 60 (mit Inbusschrauben)	KERDD60 € 133,40



STEHER

Rohrsteher, Zubehör und Fundamente

Bodenhülse mit Schnellverriegelung u. Dichtungsring

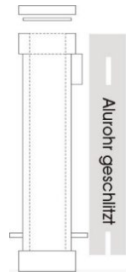

Nur für Rohrsteher mit Schlitz geeignet!

Ausführung DM / Länge	Best.-Nr. Preis
60 / 400	KFU01V € 75,20
76 / 500	KFU02V € 114,00

Ersatzteile auf Anfrage!

Bodenhülse zum Einbetonieren



mit Imbusschraube zum Fixieren des Stehers

Ausführung DM / Länge	Best.-Nr. Preis
60 / 500	KFUBHE01 € 63,20
76 / 500	KFUBHE02 € 70,80
Verschlussdeckel DM 60	KFUBHEZUB01 Anfrage
Verschlussdeckel DM 76	KFUBHEZUB02 Anfrage

Fußflansch (für Betonoberflächen)



DM 60



DM 76



DM 90

Lieferung ohne Segmentanker - benötigt werden 4 Stk. Anker pro Fußflansch



angepasster Fußflansch - passend für Montage auf Betonleitwände

Rohr-DM in mm	Best.-Nr. Preis
60	KRRZB11 € 49,00
76	KRRZB12 € 177,80
90	KRRZB13 € 266,40
Segmentanker für DM 60 und DM 76	KZBANKER02 € 9,80
Segmentanker für DM 90	KZBANKER03 € 17,80
Aufpreis für Zuschnitt BLW	KRRBZ11ZUSCH € 51,40

City Bodenhülse

Länge: 300 mm, komplett mit Gewinde- und Spannring

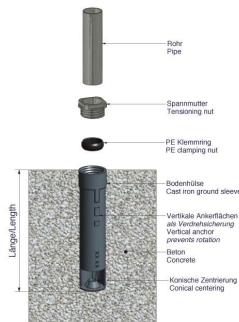

DM	Best.-Nr. Preis
60	KCITY01 € 52,50
76	KCITY02 € 58,00

Schraubfundament

KSF G 66x650-1xM8
DM 66mm, Länge: 650mm



DM

Best.-Nr.
Preis

60

KSCHRFUND
€ 46,20

Augustaflex



Modell

Best.-Nr.
Preis

mit Spreitzer
(für bestehende Fundamente)

max. Stehertlänge **4m**,
neigbar bis **45°**

für best. Steher
60/3

KAUG60360
Anfrage

mit Bodenhülse (für neue Fundamente)

max. Stehertlänge **4m**,
neigbar bis **45°**

für neuen Steher
60/3

KAUG60360B
Anfrage

Robinson mit Spreitzer (für bestehende Fundamente)

max. Stehertlänge **1,6m**,
neigbar bis **90°**

für best. Steher
60/3

KAUG60390
Anfrage

Robinson mit Bodenhülse (für neue Fundamente)

max. Stehertlänge **1,6m**,
neigbar bis **90°**

für neuen Steher
60/3

KAUG60390B
Anfrage

Long-Fix Steherverlängerung

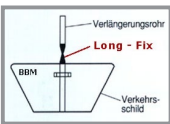

▲ long-fix und Verlängerungsrohr zusammen
locker von Hand einsetzen und ...



▲ ... beide Teile einfach gleichzeitig
eintrreiben, - Fertig!



Das Ergebnis:
◀ dauerhaft fest und
verdorhsicher
genau passend
verlängert ▶

▶▶▶
Bei Bedarf zusätzliche
Verlängerung ebenso
einfach möglich!

Rohr-DM
in mm

Best.-Nr.
Preis

Mod.60/2-160mm

KRRZB60
€ 46,70

Mod.60/3-160mm

KRRZB61
€ 50,60

Mod.76/3-160mm

KRRZB62
€ 62,30

Rohr-Clip - Rohrverlängerung im Stecksystem



Modell

Best.-Nr.
Preis

für Rohr Ø 48/2 mm

KRRZB481
€ 61,80

für Rohr Ø 60/2 mm

KRRZB601
€ 63,80

für Rohr Ø 76/3 mm

KRRZB762
€ 64,50

für Rohr Ø 90/3 mm

KRRZB902
€ 94,70



STEHER

Rohrsteher, Zubehör und Fundamente

Sonderhalterung für Betonleitwände

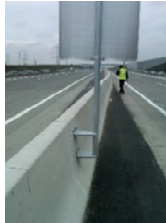

Modell	Best.-Nr. Preis
für Rohr Ø 76/3 mm	KBLW80500 € 263,20

KDE250-Sonderhalterung (für Wandmontage oder Leitschienen)



KDE250-Halterung mit 2 Stahlplatten für Befestigung auf Leitschienen

Modell	Best.-Nr. Preis
DM 60	KDE60250 € 39,80
DM 76	KDE76250 € 58,50
DM 90	KDE90250 € 66,00
Aluplatten und Schrauben	KDESHZUBEHOER Anfrage

Gabelaufsatz für Leitwinkel

mit Rohrsteher 2000mm Länge geschweißte Ausführung

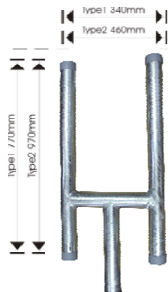

Ausführung	Tafelgröße in mm	Ausführung verzinkt	Ausführung Alu
RVS Ausführung	470x700 / Type 1	KGA01 € 186,00	KGA01A € 176,10
	600x900 / Type 2	KGA02 € 194,40	KGA02A € 183,30
Alte Ausführung	470x470 / Type 1	KGA03 Anfrage	KGA03A Anfrage
	630x630 / Type 2	KGA04 Anfrage	KGA04A Anfrage

Wandarm für Verkehrszeichen

mit Fußflansch geschweißte Ausführung

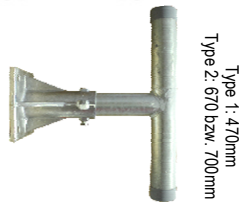

Tafelgröße in mm	Ausführung verzinkt	Ausführung Aluminium
480 Type 1	KWA01V € 140,10	KWA01A € 138,30
670/700 Type 2	KWA02V € 146,20	KWA02A € 143,50



SCHILDER VON WELT MIT UMWELTEFFEKT.



I-Steher für Großtafeln ab 4m², inkl. Befestigung

Steherlichte

Aluminium

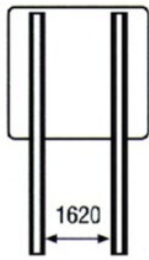

Tafelgröße: 2500x2500mm
Stehergröße: Alu 4500/180/80
Laschen Stk.: 8 Stk.

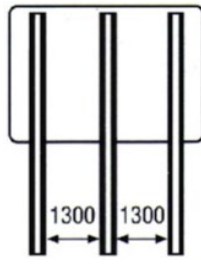

Tafelgröße: 3500x2500mm
Stehergröße: Alu 4500/180/80
Laschen Stk.: 12 Stk.

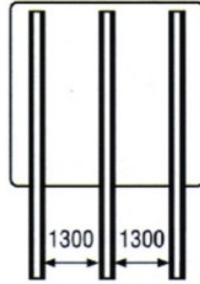

Tafelgröße: 3500x3500mm
Stehergröße: Alu 5500/180/80
Laschen Stk.: 18 Stk.



Tafelgröße: 1600x2500
Stehergröße: Alu 4500/180/80
Laschen Stk.: 8 Stk.

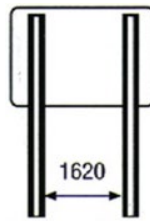

Tafelgröße: 2500x1600
Stehergröße: Alu 3500/180/80
Laschen Stk.: 6 Stk.

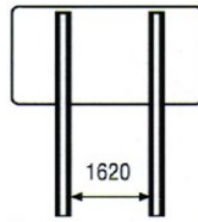

Tafelgröße: 3000x1600mm
Stehergröße: Alu 3500/180/80
Laschen Stk.: 6 Stk.

Steherlänge I-Steher 180/80

Länge	Best.-Nr. Preis
3000	KST01A € 364,90
3500	KST02A € 417,70
4000	KST03A € 470,50
4500	KST04A € 523,30
5000	KST05A € 576,10
5500	KST06A € 628,90
6000	KST07A € 681,70
6500	KST08A € 734,60
7000	KST09A € 787,40
7500	KST10A Anfrage
8000	KST11A Anfrage

Weitere Längen auf Anfrage!

Steherverlängerungen für 180/80 Aluminium Steher

mittiger Steg



Länge	Best.-Nr. Preis
500/180/80	KST20B € 226,50
750/180/80	KST21B € 256,40
1000/180/80	KST22B € 286,20
1250/180/80	KST23B € 316,10
1500/180/80	KST24B € 345,90
1750/180/80	KST25B € 375,70



STEHER

I-Steher und Zubehör

Zubehör für I-Steher

SL-Lasche für Profilsteher



Ausführung A



Ausführung B
Klemmblock

Artikel	Best.-Nr. Preis
Lasche A	KSOOLA € 11,50
Klemmteil	KSOOLAKL € 1,80
Lasche B	KSOOLB € 13,90

Abstützungen für I-Steher 180/80

bewegliche Ausführung, Steher verzinkt, DM 60/3

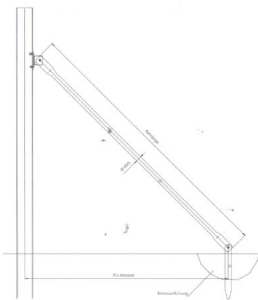

Länge	Best.-Nr. Preis
4000	KST30V € 378,40
4500	KST31V € 388,80
5000	KST32V € 399,30
5500	KST33V € 409,70
6000	KST34V € 420,10

Die Länge der Abstützung sollte der Länge der Steher über dem Gelände entsprechen, die I-Steher Abstützung ist geeignet für eine Steherlänge von 4500 mm bis 6500 mm Länge über dem Gelände!

Ersatzteile für I-Steher-Abstützung

	Verbindungsteil mit 4 SL-Laschen 80/80/8mm	KST35 € 168,00
	Gequetschtes Rohr für bewegliche Stütze	KST36 € 110,70
	Erddorn und Schraube L=640mm	KST37 € 76,20



Gitterrohrmast (gemäß RVS 05.02.13)

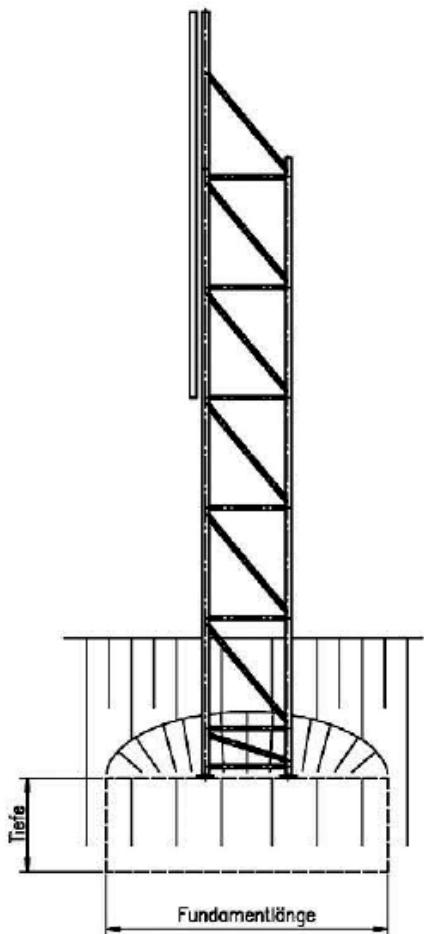

Ausführung:

Aus verschweißten und anschließend feuerverzinkten Stahl-Rundrohren.

Die Dimensionierung und Spreizung (Abstand der beiden Vertikalrohre zueinander) erfolgt nach statischen Erfordernissen.



Gitterstehertypen (Spreizung/Standrohrdurchmesser in mm)

Tafelformat B/H in mm	Abstand Fundamentoberkante bis Schildunterkante (UK) [m]									Anzahl Steher
	≤ 1,6	≤ 2,1	≤ 2,5	≤ 3,0	≤ 3,5	≤ 4,0	≤ 4,5	≤ 5,0	≤ 5,5	
2500x1500	350/48	350/48	350/48	350/48	350/48	350/48				2
2500x2000	350/48	350/48	350/48	350/48	350/48	350/48				2
3000x1500	350/48	350/48	350/48	350/48	350/48	350/48				2
2500x2500	350/48	350/48	350/48	500/60	500/61	500/62				2
2500x3000	500/60	500/60	500/60	500/60	500/60	500/60				2
2500x3500	500/60	500/60	500/60	500/60	750/60	750/60				2
3000x2000	350/48	350/48	350/48	500/60	500/60	500/60				2
3000x2500	500/60	500/60	500/60	500/60	500/60	500/60				2
3000x3000	500/60	500/60	500/60	500/60	500/60	750/60	1000/76			2
3500x2500	500/60	500/60	500/60	500/60	500/60	750/60	1000/76	1000/76		2
3500x3000	500/60	500/60	500/60	750/60	750/60	1000/76	1000/76	1000/76		2
3500x3500	500/60	750/60	1000/76	1000/76	1000/76	1000/76	1000/76	1000/76		2
3500x4000	750/60	1000/76	1000/76	1000/76	1000/76	1000/76	1000/76	1000/90		2
3500x4500	1000/76	1000/76	1000/76	1000/76	1000/76	1000/90	1000/90	1000/90		2
4000x5000	1000/76	1000/76	1000/76	1000/76	1000/76	1000/90	1000/90	1000/90	1000/90	3

Die tatsächliche Dimensionierung muss nach den örtlichen Gegebenheiten erfolgen!



STEHER

Gitterrohrmast und Zubehör

Gitterrohrmast (gemäß RVS 05.02.13)



Fundamente auf Anfrage!

Ausführung	Länge in m	Best.Nr. Preis
GRS 350/48	3,0	KGRS350481 Anfrage
	3,5	KGRS350482 Anfrage
	4,0	KGRS350483 Anfrage
	4,5	KGRS350484 Anfrage
	5,0	KGRS350485 Anfrage
	5,5	KGRS350486 Anfrage
GRS 500/60	4,5	KGRS500601 Anfrage
	5,0	KGRS500602 Anfrage
	5,5	KGRS500603 Anfrage
	6,0	KGRS500604 Anfrage
	6,5	KGRS500605 Anfrage
GRS 750/60	5,5	KGRS750601 Anfrage
	6,0	KGRS750602 Anfrage
	6,5	KGRS750603 Anfrage
GRS 1000/76	6,0	KGRS1000761 Anfrage
	6,5	KGRS1000762 Anfrage
	7,0	KGRS1000763 Anfrage
	7,5	KGRS1000764 Anfrage
	8,0	KGRS1000765 Anfrage
	8,5	KGRS1000766 Anfrage
GRS 1000/90	8,5	KGRS1000901 Anfrage
	9,0	KGRS1000902 Anfrage

Weitere Längen auf Anfrage!

Ankerkorb für Gittersteher



Lieferung ohne Abdeckkappen!







Ausführung	für Gitterrohrsteher Länge in m	Best.Nr. Preis
350/48	3,0 - 5,5 m	KGRAK35048 Anfrage
500/60	4,5 - 6,5 m	KGRAK50060 Anfrage
750/60	5,5 - 6,5 m	KGRAK75060 Anfrage
1000/76	6,0 - 8,5 m	KGRAK100076 Anfrage
1000/90	8,5 - 10,5 m	KGRAK100090 Anfrage



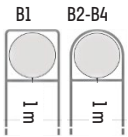



Abdeckkappen auf Anfrage!

ROHRRAHMEN







Rohrrahmen und Zubehör

Rohrrahmen

ROHRRAHMEN	Type	Größe der Verkehrszeichen in mm	komplett mit Befestigungslaschen für die einseitige Tafelmontage			Aufpreis für beidseitige Tafelmontage pro Klemme € 3,98 erford. Anzahl
			Achismaß in m	Rohr-DM/Wandstärke	verzinkt	
	A1	1500	1,6	60/3	KRRA102V € 455,90	4
	A2	1000	1,1	60/2	KRRA202V € 302,30	4
	A3	700	0,8	60/2	KRRA302V € 336,30	3
	B1	1200	1,3	60/3	KRRB102V Anfrage	4
	B2	960	1,1	60/3	KRRB202V € 569,50	4
	B3	670	0,8	60/2	KRRB302V € 558,50	4
	B4	480	0,6	60/2	KRRB402V € 451,50	4
	C1	960x960	1,1	60/2	KRRC102V € 403,90	6
	C2	630x630	0,8	60/2	KRRC202V € 346,70	4
	C3	1500x1500	1,6	76/3 90/3	KRRC302V € 881,60	8
	CF1	1160x1160	1,3	60/3	KRRCF102V € 445,60	6
	CF2	940x940	1,1	60/2	KRRCF202V € 401,40	6
	CF3	630x630	0,8	60/2	KRRCF302V € 345,10	4
	D1	1000x2000	1,1	76/3 90/3	KRRD102V € 846,60	8
	D2	1000x1500	1,1	60/3 76/3	KRRD202V € 659,10	8
	D3	960x1200	1,1	60/3	KRRD302V € 442,00	6
	D4	630x960	0,8	60/3	KRRD402V € 428,60	6
	E2	2000x1000	2,1	60/3 76/3	KRRE202V € 663,80	8
	E3	1500x1000	1,6	60/3 76/3	KRRE302V € 647,20	8
	E4	960x630	1,1	60/2	KRRE402V € 396,40	6
	E5	2000x1500	2,1	60/3 76/3	KRRE502V € 715,70	10
		F1	2000x1000 / 2000x310	2,1	76/3 90/3	KRRF102V € 1.116,90
F2		1500x1000 / 1500x310	1,6	60/3 76/3	KRRF202V € 807,20	14
F3		960x630 / 960x310	1,1	60/2	KRRF302V € 548,60	12
	S5	2500x620	2,6	60/3 76/3	KRRS502V € 651,10	8
	S6	2000x470	2,1	60/3	KRRS602V € 447,40	6
	S7	1150x310	1,3	60/2	KRRS702V € 348,50	4

ROHRRAHMEN	Type	Größe der Verkehrszeichen in mm	komplett mit Befestigungslaschen für die einseitige Tafelmontage			Aufpreis für beidseitige Tafelmontage pro Klemme € 3,98 erford. Anzahl
			Achismaß in m	Rohr-DM/Wandstärke	verzinkt	
	T5-B60	2500x620	2,6	60/3	KRRT502V € 486,80	8
	T6-A48	2000x470	2,1	60/2	KRRT602V € 400,90	6
	T7-A48	1150x310	1,3	60/2	KRRT702V € 333,40	4
	U1	2x960	1,1	60/3 76/3	KRRU102V € 929,00	8
	U2	2x670	0,8	60/3 76/3	KRRU202V € 867,50	8
	V1	960 / 1000	1,1	60/3 76/3	KRRV102V € 929,00	8
	V2	670 / 700	0,8	60/3 76/3	KRRV202V € 858,00	7
	W1	960 / 960x310	1,1	60/3 76/3	KRRW102V € 920,20	8
	W2	670 / 630x310	0,8	60/2	KRRW202V € 703,20	8
	W3	480 / 480x230	0,6	60/2	KRRW302V € 614,50	8
	X1	1500 / 960x480	1,6	60/3 76/3	KRRX102V € 762,80	8
	X2	1000 / 960x480	1,1	60/2	KRRX202V € 517,80	8
	X3	700 / 630x310	0,8	60/2	KRRX302V € 506,80	7
	Y1	960x960 / 960x310	1,1	60/3 76/3	KRRY102V € 754,00	10
	Y2	630x630 / 630x310	0,8	60/2	KRRY202V € 516,90	8
	Z1	1000x2000 / 1000x480	1,1	76/3 90/3	KRRZ102V € 1.079,10	12
	Z2	1000x1500 / 1000x480	1,1	76/3 90/3	KRRZ202V € 1.056,00	12
	Z3	960x1200 / 960x310	1,1	60/3 76/3	KRRZ302V € 768,20	10
	Z4	630x960 / 630x230	0,8	60/3	KRRZ402V € 581,30	10

Rohrrahmen in Aluminium-Ausführung auf Anfrage!

ROHRRAHMEN	Type	Größe der Verkehrszeichen in mm	komplett mit Befestigungslaschen für die einseitige Tafelmontage			Aufpreis für beidseitige Tafelmontage pro Klemme € 3,98 erford. Anzahl
			Achismaß in m	Rohr-DM/Wandstärke	verzinkt	
Rohrrahmen für Wegweiser						
1150 	GA-01	1150x250	1,3	60/2	KRRGA01V € 347,80	4
	GA-03	1150x400	1,3	60/2	KRRGA03V € 401,60	4
	GA-05	1150x620	1,3	60/2	KRRGA05V € 384,20	4
1460 	GB-01	1460x250	1,61	60/2	KRRGB01V € 371,60	6
	GB-02	1460x330	1,61	60/2	KRRGB02V € 372,30	6
	GB-03	1460x400	1,61	60/2	KRRGB03V € 373,80	6
	GB-04	1460x500	1,61	60/2	KRRGB04V € 404,30	6
	GB-05	1460x620	1,61	60/2	KRRGB05V € 408,80	6
	GB-06	1460x660	1,61	60/2	KRRGB06V € 409,50	6
1740 	GC-02	1740x330	1,89	60/2	KRRGC02V € 397,10	6
	GC-04	1740x500	1,89	60/2	KRRGC04V € 433,00	6
	GC-06	1740x660	1,89	60/3	KRRGC06V € 506,40	8
	GC-07	1740x750	1,89	60/3	KRRGC07V € 514,00	8
2200 	GD-02	2200x330	2,35	60/2	KRRGD02V € 423,20	8
	GD-03	2200x400	2,35	60/2	KRRGD03V € 451,10	8
	GD-04	2200x500	2,35	60/3	KRRGD04V € 486,70	8
	GD-06	2200x660	2,35	60/2 76/3	KRRGD06V € 643,70	8
	GD-07	2200x750	2,35	60/2 76/3	KRRGD07V € 647,70	8
	GD-08	2200x900	2,35	60/3 76/3	KRRGD08V € 699,00	10
2500 	GE-03	2500x400	2,65	60/3	KRRGE03V € 495,70	8
	GE-06	2500x660	2,65	60/3 76/3	KRRGE06V € 693,90	10
	GE-08	2500x900	2,65	60/3 76/3	KRRGE08V € 707,30	10
1150 	HA-01	1150x(250+250)	1,3	60/2	KRRHA01V € 502,10	8
	HA-02	1150x(400+250)	1,3	60/2	KRRHA02V € 523,50	10
	HA-03	1150x(250+400)	1,3	60/2	KRRHA03V € 523,50	10
	HA-05	1150x(400+400)	1,3	60/2	KRRHA05V € 544,80	12
	HA-08	1150x(620+250)	1,3	60/2	KRRHA08V € 537,90	10
	HA-09	1150x(250+620)	1,3	60/2	KRRHA09V € 557,70	10

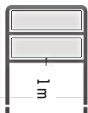

ROHRRAHMEN	Type	Größe der Verkehrszeichen in mm	komplett mit Befestigungsglaschen für die einseitige Tafelmontage			Aufpreis für beidseitige Tafelmontage pro Klemme € 3,98 erford. Anzahl	
			Achismaß in m	Rohr-DM/Wandstärke	verzinkt		
	HA-13	1150x(620+400)	1,3	60/2 76/3	KRRHA13V € 748,70	12	
	HA-14	1150x(400+620)	1,3	60/2 76/3	KRRHA14V € 748,70	12	
	HA-21	1150x(620+620)	1,3	60/2 76/3	KRRHA21V € 764,60	12	
1460 	HB-01	1460x(250+250)	1,61	60/2	KRRHB01V € 547,30	12	
	HB-02	1460x(400+250)	1,61	60/3	KRRHB02V € 581,20	12	
	HB-03	1460x(250+400)	1,61	60/3	KRRHB03V € 581,20	12	
	HB-04	1460x(330+330)	1,61	60/3	KRRHB04V € 581,20	12	
	HB-05	1460x(400+400)	1,61	60/3	KRRHB05V € 585,10	12	
	HB-06	1460x(500+330)	1,61	60/3	KRRHB06V € 619,60	12	
	HB-07	1460x(330+500)	1,61	60/3	KRRHB07V € 619,60	12	
	HB-08	1460x(620+250)	1,61	60/3	KRRHB08V € 642,70	12	
	HB-09	1460x(250+620)	1,61	60/3	KRRHB09V € 642,70	12	
	HB-10	1460x(660+330)	1,61	60/3 76/3	KRRHB10V € 791,20	12	
	HB-11	1460x(330+660)	1,61	60/3 76/3	KRRHB11V € 791,20	12	
	HB-12	1460x(500+500)	1,61	60/3 76/3	KRRHB12V € 800,70	12	
	HB-13	1460x(620+400)	1,61	60/3 76/3	KRRHB13V € 790,10	12	
	HB-14	1460x(400+620)	1,61	60/3 76/3	KRRHB14V € 790,10	12	
	HB-19	1460x(660+500)	1,61	60/3 76/3	KRRHB19V € 809,80	12	
	HB-20	1460x(500+660)	1,61	60/3 76/3	KRRHB20V € 809,80	12	
	HB-21	1460x(620+620)	1,61	60/3 76/3	KRRHB21V € 812,00	12	
	HB-26	1460x(660+660)	1,61	60/3 76/3	KRRHB26V € 816,60	12	
	1740 	HC-04	1740x(330+330)	1,89	60/3	KRRHC04V € 628,40	12
		HC-06	1740x(500+330)	1,89	60/3 76/3	KRRHC06V € 789,70	12
		HC-07	1740x(330+500)	1,89	60/3 76/3	KRRHC07V € 763,10	12
HC-10		1740x(660+330)	1,89	60/3 76/3	KRRHC10V € 817,90	14	
HC-11		1740x(330+660)	1,89	60/3 76/3	KRRHC11V € 817,90	14	
HC-12		1740x(500+500)	1,89	60/3 76/3	KRRHC12V € 812,60	12	
HC-17		1740x(750+330)	1,89	60/3 76/3	KRRHC17V € 822,80	14	
HC-18		1740x(330+750)	1,89	60/3 76/3	KRRHC18V € 822,80	14	

BEFESTIGUNGSSYSTEME

ROHRRAHMEN	Type	Größe der Verkehrszeichen in mm	komplett mit Befestigungslaschen für die einseitige Tafelmontage			Aufpreis für beidseitige Tafelmontage pro Klemme € 3,98 erford. Anzahl
			Achismaß in m	Rohr-DM/Wandstärke	verzinkt	
	HC-19	1740x(660+500)	1,89	60/3 76/3	KRRHC19V € 836,50	14
	HC-20	1740x(500+660)	1,89	60/3 76/3	KRRHC20V € 836,50	14
	HC-22	1740x(750+500)	1,911	76/3 90/3	KRRHC22V € 1.143,60	14
	HC-23	1740x(500+750)	1,911	76/3 90/3	KRRHC23V € 1.143,60	14
	HC-26	1740x(660+660)	1,911	76/3 90/3	KRRHC26V € 1.166,40	16
	HC-27	1740x(750+750)	1,911	76/3 90/3	KRRHC27V € 1.176,40	16
2200	HD-04	2200x(330+330)	2,35	60/3	KRRHD04V € 679,10	16
	HD-05	2200x(400+400)	2,35	60/2 76/3	KRRHD05V € 797,90	16
	HD-06	2200x(500+330)	2,35	60/2 76/3	KRRHD06V € 855,90	16
	HD-07	2200x(330+500)	2,35	60/2 76/3	KRRHD07V € 855,90	16
	HD-12	2200x(500+500)	2,35	60/3 76/3	KRRHD12V € 907,80	16
	HD-15	2200x(660+400)	2,35	60/3 76/3	KRRHD15V € 895,20	16
	HD-16	2200x(400+660)	2,35	60/3 76/3	KRRHD16V € 895,20	16
	HD-17	2200x(750+330)	2,35	60/3 76/3	KRRHD17V € 898,40	16
	HD-18	2200x(330+750)	2,35	60/3 76/3	KRRHD18V € 898,40	16
	HD-22	2200x(750+500)	2,371	76/3 90/3	KRRHD22V € 1.147,90	16
	HD-23	2200x(500+750)	2,371	76/3 90/3	KRRHD23V € 1.147,90	16
	HD-24	2200x(900+400)	2,371	76/3 90/3	KRRHD24V € 1.151,00	16
	HD-25	2200x(400+900)	2,371	76/3 90/3	KRRHD25V € 1.151,00	16
	HD-26	2200x(660+660)	2,371	76/3 90/3	KRRHD26V € 1.151,70	16
2500	HE-05	2500x(400+400)	2,65	60/3	KRRHE05V € 722,60	16
	HE-15	2500x(660+400)	2,671	76/3 90/3	KRRHE15V € 1.149,20	18
	HE-16	2500x(400+660)	2,671	76/3 90/3	KRRHE16V € 1.149,20	18
	HE-24	2500x(900+400)	2,671	76/3 90/3	KRRHE24V € 1.164,20	18
	HE-25	2500x(400+900)	2,671	76/3 90/3	KRRHE25V € 1.164,20	18
	HE-26	2500x(660+660)	2,671	76/3 90/3	KRRHE26V € 1.200,60	20



SCHILDER VON WELT MIT UMWELTEFFEKT.

ITEK

ROHRRAHMEN

1150

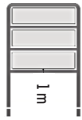

Type	Größe der Verkehrszeichen in mm	komplett mit Befestigungsglaschen für die einseitige Tafelmontage			Aufpreis für beidseitige Tafelmontage pro Klemme € 3,98 erford. Anzahl
		Achismaß in m	Rohr-DM/Wandstärke	verzinkt	
HFA-01	1150x(250+250+250)	1,3	60/2	KRRHFA01V € 636,70	12
HFA-02	1150x(400+250+250)	1,3	60/2	KRRHFA02V € 639,00	12
HFA-03	1150x(250+400+250)	1,3	60/2	KRRHFA03V € 639,00	12
HFA-04	1150x(250+250+400)	1,3	60/2	KRRHFA04V € 639,00	12
HFA-06	1150x(400+400+250)	1,3	60/2	KRRHFA06V € 641,20	12
HFA-07	1150x(250+400+400)	1,3	60/2	KRRHFA07V € 641,20	12
HFA-08	1150x(400+250+400)	1,3	60/2	KRRHFA08V € 641,20	12
HFA-09	1150x(620+250+250)	1,3	60/3	KRRHFA09V € 753,30	14
HFA-10	1150x(250+620+250)	1,3	60/3	KRRHFA10V € 753,30	14
HFA-11	1150x(250+250+620)	1,3	60/3	KRRHFA11V € 753,30	14
HFA-15	1150x(400+400+400)	1,3	60/3 76/3	KRRHFA15V € 921,90	18
HFA-16	1150x(620+400+250)	1,3	60/3 76/3	KRRHFA16V € 922,20	16
HFA-17	1150x(250+620+400)	1,3	60/3 76/3	KRRHFA17V € 922,20	16
HFA-18	1150x(250+400+620)	1,3	60/3 76/3	KRRHFA18V € 922,20	16
HFA-19	1150x(620+250+400)	1,3	60/3 76/3	KRRHFA19V € 922,20	16
HFA-20	1150x(400+620+250)	1,3	60/3 76/3	KRRHFA20V € 922,20	16
HFA-21	1150x(400+250+620)	1,3	60/3 76/3	KRRHFA21V € 922,20	16
HFA-31	1150x(620+400+400)	1,3	60/3 76/3	KRRHFA31V € 946,10	18
HFA-32	1150x(400+620+400)	1,3	60/3 76/3	KRRHFA32V € 946,10	18
HFA-33	1150x(400+400+620)	1,3	60/3 76/3	KRRHFA33V € 946,10	18
HFA-43	1150x(620+620+250)	1,3	60/3 76/3	KRRHFA43V € 944,10	16
HFA-44	1150x(620+250+620)	1,3	60/3 76/3	KRRHFA44V € 944,10	16
HFA-45	1150x(250+620+620)	1,3	60/3 76/3	KRRHFA45V € 944,10	16
HFA-53	1150x(620+620+400)	1,3	76/3 90/3	KRRHFA53V € 1.276,30	18
HFA-54	1150x(620+400+620)	1,3	76/3 90/3	KRRHFA54V € 1.276,30	18
HFA-55	1150x(400+620+620)	1,3	76/3 90/3	KRRHFA55V € 1.276,30	18
HFA-77	1150x(250+620+250)	1,3	76/3 90/3	KRRHFA77V € 1.299,70	18

ROHRRAHMEN	Type	Größe der Verkehrszeichen in mm	komplett mit Befestigungslaschen für die einseitige Tafelmontage			Aufpreis für beidseitige Tafelmontage pro Klemme € 3,98 erford. Anzahl
			Achismaß in m	Rohr-DM/Wandstärke	verzinkt	
1460 	HFB-01	1460x(250+250+250)	1,6	60/2	KRRHFB01V € 723,10	18
	HFB-02	1460x(400+250+250)	1,6	60/3	KRRHFB02V € 760,60	18
	HFB-03	1460x(250+400+250)	1,6	60/3	KRRHFB03V € 760,60	18
	HFB-04	1460x(250+250+400)	1,6	60/3	KRRHFB04V € 760,60	18
	HFB-05	1460x(330+330+330)	1,6	60/3	KRRHFB05V € 763,00	18
	HFB-06	1460x(400+400+250)	1,61	60/3 76/3	KRRHFB06V € 927,90	18
	HFB-07	1460x(250+400+400)	1,61	60/3 76/3	KRRHFB07V € 927,90	18
	HFB-08	1460x(400+250+400)	1,61	60/3 76/3	KRRHFB08V € 927,90	18
	HFB-09	1460x(620+250+250)	1,61	60/3 76/3	KRRHFB09V € 947,30	18
	HFB-10	1460x(250+620+250)	1,61	60/3 76/3	KRRHFB10V € 947,30	18
	HFB-11	1460x(250+250+620)	1,61	60/3 76/3	KRRHFB11V € 947,30	18
	HFB-12	1460x(330+330+500)	1,61	60/3 76/3	KRRHFB12V € 947,30	18
	HFB-13	1460x(330+500+330)	1,61	60/3 76/3	KRRHFB13V € 947,30	18
	HFB-14	1460x(330+330+500)	1,61	60/3 76/3	KRRHFB14V € 944,00	18
	HFB-15	1460x(400+400+400)	1,61	60/3 76/3	KRRHFB15V € 931,50	18
	HFB-16	1460x(620+400+250)	1,61	60/3 76/3	KRRHFB16V € 949,70	18
	HFB-17	1460x(250+620+400)	1,61	60/3 76/3	KRRHFB17V € 949,70	18
	HFB-18	1460x(250+400+620)	1,61	60/3 76/3	KRRHFB18V € 949,70	18
	HFB-19	1460x(620+250+400)	1,61	60/3 76/3	KRRHFB19V € 949,70	18
	HFB-20	1460x(400+620+250)	1,61	60/3 76/3	KRRHFB20V € 949,70	18
	HFB-21	1460x(400+250+620)	1,61	60/3 76/3	KRRHFB21V € 949,70	18
	HFB-22	1460x(660+330+330)	1,61	60/3 76/3	KRRHFB22V € 952,00	18
	HFB-23	1460x(330+660+330)	1,61	60/3 76/3	KRRHFB23V € 952,00	18
	HFB-24	1460x(330+330+660)	1,61	60/3 76/3	KRRHFB24V € 952,00	18
	HFB-25	1460x(500+500+330)	1,61	60/3 76/3	KRRHFB25V € 962,60	18
	HFB-26	1460x(330+500+500)	1,61	60/3 76/3	KRRHFB26V € 962,60	18
	HFB-27	1460x(500+330+500)	1,61	60/3 76/3	KRRHFB27V € 962,60	18
	HFB-31	1460x(620+400+400)	1,631	76/3 90/3	KRRHFB31V € 1.263,90	18
	HFB-32	1460x(400+620+400)	1,631	76/3 90/3	KRRHFB32V € 1.263,90	18
	HFB-33	1460x(400+400+620)	1,631	76/3 90/3	KRRHFB33V € 1.263,90	18

ROHRRAHMEN	Type	Größe der Verkehrszeichen in mm	komplett mit Befestigungslaschen für die einseitige Tafelmontage			Aufpreis für beidseitige Tafelmontage pro Klemme € 3,98 erford. Anzahl
			Achismaß in m	Rohr-DM/Wandstärke	verzinkt	
	HFB-37	1460x(660+500+330)	1,631	76/3 90/3	KRRHFB37V € 1.281,40	18
	HFB-38	1460x(500+660+330)	1,631	76/3 90/3	KRRHFB38V € 1.281,40	18
	HFB-39	1460x(500+330+660)	1,631	76/3 90/3	KRRHFB39V € 1.281,40	18
	HFB-40	1460x(660+330+500)	1,631	76/3 90/3	KRRHFB40V € 1.281,40	18
	HFB-41	1460x(330+660+500)	1,631	76/3 90/3	KRRHFB41V € 1.281,40	18
	HFB-42	1460x(330+500+660)	1,631	76/3 90/3	KRRHFB42V € 1.281,40	18
	HFB-43	1460x(620+620+250)	1,631	76/3 90/3	KRRHFB43V € 1.283,50	18
	HFB-44	1460x(620+250+620)	1,631	76/3 90/3	KRRHFB44V € 1.283,50	18
	HFB-45	1460x(250+620+620)	1,631	76/3 90/3	KRRHFB45V € 1.283,50	18
	HFB-46	1460x(500+500+500)	1,631	76/3 90/3	KRRHFB46V € 1.290,80	18
	HFB-53	1460x(620+620+400)	1,631	76/3 90/3	KRRHFB53V € 1.287,30	18
	HFB-54	1460x(620+400+620)	1,631	76/3 90/3	KRRHFB54V € 1.287,30	18
	HFB-55	1460x(400+620+620)	1,631	76/3 90/3	KRRHFB55V € 1.287,30	18
	HFB-56	1460x(660+660+330)	1,631	76/3 90/3	KRRHFB56V € 1.290,80	18
	HFB-57	1460x(660+330+660)	1,631	76/3 90/3	KRRHFB57V € 1.290,80	18
	HFB-58	1460x(330+660+660)	1,631	76/3 90/3	KRRHFB58V € 1.290,80	18
	HFB-59	1460x(660+500+500)	1,631	76/3 90/3	KRRHFB59V € 1.300,20	18
	HFB-60	1460x(500+660+500)	1,631	76/3 90/3	KRRHFB60V € 1.300,20	18
	HFB-61	1460x(500+500+660)	1,631	76/3 90/3	KRRHFB61V € 1.300,20	18
1740	HFC-05	1740x(330+330+330)	1,89	60/3	KRRHFC05V € 1.101,70	18
	HFC-12	1740x(500+330+330)	1,89	60/3 76/3	KRRHFC12V € 953,80	18
	HFC-13	1740x(330+500+330)	1,89	60/3 76/3	KRRHFC13V € 953,80	18
	HFC-14	1740x(330+330+500)	1,89	60/3 76/3	KRRHFC14V € 953,80	18
	HFC-22	1740x(660+330+330)	1,911	76/3 90/3	KRRHFC22V € 1.331,70	20
	HFC-23	1740x(330+660+330)	1,911	76/3 90/3	KRRHFC23V € 1.331,70	20
	HFC-24	1740x(330+330+660)	1,911	76/3 90/3	KRRHFC24V € 1.331,70	20
	HFC-25	1740x(500+500+330)	1,911	76/3 90/3	KRRHFC25V € 1.321,50	18
	HFC-26	1740x(330+500+500)	1,911	76/3 90/3	KRRHFC26V € 1.321,50	18

ROHRRAHMEN	Type	Größe der Verkehrszeichen in mm	komplett mit Befestigungslaschen für die einseitige Tafelmontage			Aufpreis für beidseitige Tafelmontage pro Klemme: € 3,98 erford. Anzahl
			Achismaß in m	Rohr-DM/Wandstärke	verzinkt	
	HFC-27	1740x(500+330+500)	1,911	76/3 90/3	KRRHFC27V € 1.321,50	18
	HFC-28	1740x(750+330+330)	1,911	76/3 90/3	KRRHFC28V € 1.317,00	18
	HFC-29	1740x(330+750+330)	1,911	76/3 90/3	KRRHFC29V € 1.317,00	18
	HFC-30	1740x(330+330+750)	1,911	76/3 90/3	KRRHFC30V € 1.317,00	18
	HFC-37	1740x(660+500+330)	1,911	76/3 90/3	KRRHFC37V € 1.350,50	20
	HFC-38	1740x(500+660+330)	1,911	76/3 90/3	KRRHFC38V € 1.350,50	20
	HFC-39	1740x(500+330+660)	1,911	76/3 90/3	KRRHFC39V € 1.350,50	20
	HFC-40	1740x(660+330+500)	1,911	76/3 90/3	KRRHFC40V € 1.350,50	20
	HFC-41	1740x(330+660+500)	1,911	76/3 90/3	KRRHFC41V € 1.350,50	20
	HFC-42	1740x(330+500+660)	1,911	76/3 90/3	KRRHFC42V € 1.350,50	20
	HFC-46	1740x(500+500+500)	1,911	76/3 90/3	KRRHFC46V € 1.340,30	18
2200	HFD-05	2200x(330+330+330)	2,371	76/3 90/3	KRRHFD05V € 1.361,80	24
	HFD-12	2200x(500+330+330)	2,371	76/3 90/3	KRRHFD12V € 1.380,60	24
	HFD-13	2200x(330+500+330)	2,371	76/3 90/3	KRRHFD13V € 1.380,60	24
	HFD-14	2200x(330+330+500)	2,371	76/3 90/3	KRRHFD14V € 1.380,60	24
	HFD-15	2200x(400+400+400)	2,371	76/3 90/3	KRRHFD15V € 1.366,80	24
	HFD-25	2200x(500+500+330)	2,371	76/3 90/3	KRRHFD25V € 1.394,40	24
	HFD-26	2200x(330+500+500)	2,371	76/3 90/3	KRRHFD26V € 1.394,40	24
	HFD-27	2200x(500+330+500)	2,371	76/3 90/3	KRRHFD27V € 1.399,50	24
2500	HFE-15	2500x(400+400+400)	2,61	76/3 90/3	KRRHFE15V € 1.377,20	24

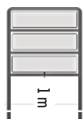

Rohrrahmen in Aluminium-Ausführung auf Anfrage!











WIR SETZEN ZEICHEN.

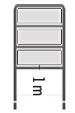

ITEK



ROHRRAHMEN	Type	Größe der Verkehrszeichen in mm	komplett mit Befestigungslaschen für die einseitige Tafelmontage			Aufpreis für beidseitige Tafelmontage pro Klemme: € 3,98 erford. Anzahl
			Achismaß in m	Rohr-DM/Wandstärke	verzinkt	
Rohrrahmen für Wegweiser (alte Formate)						
	G1	2300x620	2,4	60/3	KRRG102V € 616,10	8
	G2	1740x460	1,9	60/2	KRRG202V € 403,60	6
	G3	1150x310	1,3	60/2	KRRG302V € 348,50	4
	H1	2300x620x2	2,4	60/3 76/3	KRRH102V € 841,70	16
	H2	1740x460x2	1,9	60/3 76/3	KRRH202V € 767,00	12
	H3	1150x310x2	1,3	60/2	KRRH302V € 504,40	8
	HF1	1150x310x3	1,3	60/3	KRRHF102V € 692,40	12
	HF2	1740x460x3	1,9	76/3 90/3	KRRHF202V € 1.269,70	18
	HF3	2200x460x3	2,4	76/3 90/3	KRRHF301V € 1.380,00	24
	HF4	1740x460x4	1,9	76/3 90/3	KRRHF401V € 1.526,60	24
	PF1	(1740+1740) x460	3,6	60/3	KRRPF102V € 568,70	12
	PF2	(1150+1150) x310	2,4	60/2	KRRPF202V € 443,70	8
	J1	2300x620 1740x460	2,4	60/3 76/3	KRRJ102V € 817,10	14
	J2	1740x460 1150x310	1,9	60/3	KRRJ202V € 597,40	10
	L1	2600x700	2,7	60/3 76/3	KRRL102V € 647,30	10
	L2	2200x460	2,3	60/3	KRRL202V € 466,20	8
	L3	1460x310	1,6	60/2	KRRL302V € 372,30	6
	M2	2200x460x2	2,3	60/3 76/3	KRRM202V € 845,90	16
	M3	1460x310x2	1,6	60/2	KRRM302V € 569,40	12
	N2	2200x460 1150x310	2,3	60/3 76/3	KRRN202V € 794,50	12



Rohrrahmen in Aluminium-Ausführung auf Anfrage!

Zubehör

Krümmen



Rohr-DM in mm	Best.-Nr Preis
48	KRRZB01 € 56,00
60	KRRZB02 € 63,70
76	KRRZB03 € 104,90
90	KRRZB04 € 131,80

T-Stück



Rohr-DM in mm	Best.-Nr Preis
60° - 60**	KRRZB06 € 44,40
48° - 48**	KRRZB07 € 58,50
60° - 48**	KRRZB08 € 40,30
90° - 76**	KRRZB09 € 91,10
76° - 60**	KRRZB10 € 68,40

Rohrrahmenlaschen



Ausführung	Rohr-DM in mm	Best.-Nr Preis
einseitig	48	KRRZB17 € 8,00
	60	KRRZB18 € 8,00
	76	KRRZB18A € 8,20
beidseitig	48	KRRZB19 € 8,90
	60	KRRZB20 € 9,50
	76	KRRZB20A € 9,50
Klemme B		KRRZB21 € 4,30
Verstärkungsprofil	30x20 per lfm.	KRRZB22 € 35,10



ROHRRAHMEN

Rohrrahmen und Zubehör

Rohre für Querstreben

gelocht für Gußteil Rohrrahmentype angeben Preise per lfm.		Ausführung	Rohr-DM in mm	Best.-Nr Preis/lfm
		verzinkt	48	KRRZB23 € 30,50
			60	KRRZB24 € 33,30
			76	KRRZB25 € 42,20

Abstützung f. Rohrsteher

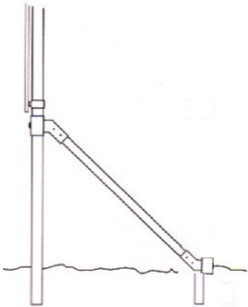
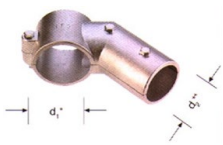
 <p>Länge des Abstützungsrohrs: Abstand Boden bis Tafeloberkante</p>	 <p>unbewegliche Schelle</p>	Ausführung	Rohr-DM in mm	Best.-Nr Preis
		unbeweglich	60° - 60**	KRRZB29 € 72,60
			76° - 60**	KRRZB30 € 79,90
			90° - 60**	KRRZB31 € 82,40
		beweglich	60° - 48**	KRRZB41 € 82,00
			60° - 60**	KRRZB42 € 82,00
		Abstützrohr DM 60 per lfm	verzinkt	KRRZB32 € 29,40
			Alu	KRRZB33 € 28,70

Schelle

 <p>Weitere Größen auf Anfrage!</p>	DM * DM **	Ausführung	Best.-Nr Preis
		48° - 60**	KRRZB54 € 50,70
		60° - 76**	KRRZB55 € 68,90
		76° - 90**	KRRZB56 € 90,30

Steherverlängerungen (aufschraubbar, bestehend aus Schelle und Rohr) - verzinkte Ausführung

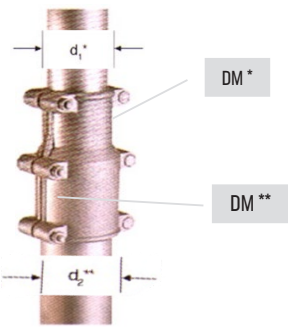
 <p>Ausführung in Alu auf Anfrage!</p>	Länge	Ausführung	Best.-Nr Preis
	1000	48° - 60**	KRRZB34 € 61,30
	1000	60° - 76**	KRRZB35 € 63,10
	1000	76° - 90**	KRRZB36 € 74,80
	1500	48° - 60**	KRRZB37 € 77,90
	1500	60° - 76**	KRRZB38 € 80,60
	1500	76° - 90**	KRRZB39 € 98,10

LRR-76: Hochwertige Rohrrahmen für Leitsysteme und Infoschilder

Ausführung in Alu natur oder RAL-beschichtet

Ausführung	Best-Nr Preis
Alu natur	KLRR76 Anfrage
RAL beschichtet	KLRRB76 Anfrage

Ausführung der Schilder in flach oder Hohlprofil



Leitsystem Michaelerberg-Pruggern
Leitsystem mit integriertem Klapprahmen, 2-teiliges Leitsystem
Ausführung Alu beschichtet

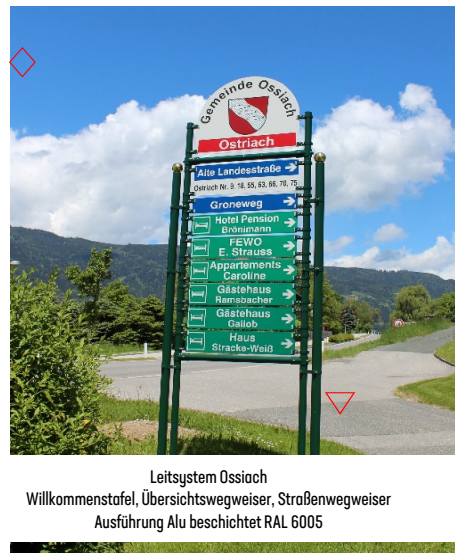

Leitsystem Ossiach
Willkommenstafel, Übersichtswegweiser, Straßenwegweiser
Ausführung Alu beschichtet RAL 6005



DIGITALDRUCK MACHT EINDRUCK.

ITEK



LRR-76: Hochwertige Rohrrahmen für Leitsysteme und Infoschilder

Ausführung in Alu natur oder RAL-beschichtet



Willkommenstafel Guttaring
Ausführung NIRO
mit konturgeschnittenen Schildern



Willkommenstafel Magdalensberg
Alu beschichtet
mit konturgeschnittenen Schildern



Leitsystem Nötsch
Ausführung Alu mit Zierkugeln
mit Wappenschild



Leitsystem St. Andrä im Lav.
Ausführung Alu beschichtet
mit Wappenschild



Leitsystem Hohe Tauern

Ausführung in Alu natur oder RAL-beschichtet



Leitsystem Globasnitz-Globasnica



Leitsystem Pörtlach



Begegnungszone
Ausführung Alu beschichtet



Willkommenstafel St. Margareten im Ros.
Ausführung Alu beschichtet



Infotafel Feistritz ob Bleiburg



LRR-76: Hochwertige Rohrrahmen für Leitsysteme und Infoschilder

Nirosta-Ausführung



Infotafel Gmünd



Infotafel Feistritz an der Gail







Infotafel Obervellach



Infotafel Mörttschach

Strassenbezeichnungstafeln

Farbauswahl

Grund	Schrift u. Rand	Farbe			
blau 100-17	weiss 100-10	 1 	<p>Weitere Farben auf Anfrage!</p> <p>Gilt nicht für geprägte Schilder! Standardschrift: Helvetica, weitere Schriften auf Anfrage!</p>	<p>Bestellinfo</p> <p>KSH001EA1 = vorletzter Buchstabe ergibt die Randausführung; letzte Zahl ergibt die Farbe</p>	
grün 100-122	weiss 100-10	 2 			
weiss 100-10	schwarz 100-12	 5 			

Randausführungen



Ausführung "A" - eckiger Rand



Ausführung "B" - abgerundeter Rand



Ausführung "C" - Zierrand



Ausführung "D" - ohne Rand

Strassenbezeichnungstafeln Ausführung flach

Ausführung: Aluminium, 2mm Befestigung: KC-Laschen	Maße	Scotchcal-Folie nicht rückstrahlend		Folie Type 1 AEGP rückstrahlend	
		KSA03..	€ 58,80	KSA01..	€ 41,70
	550x150/2	KSA07..	€ 61,30	KSA05..	€ 44,40
	620x150/2	KSA11..	€ 66,40	KSA09..	€ 48,60
	750x150/2				

Strassenbezeichnungstafeln Ausführung Alform

Ausführung: Aluminium 2mm mit Profilrand Befestigung: U-Laschen	Maße	Scotchcal-Folie nicht rückstrahlend		Folie Type 1 AEGP rückstrahlend	
		KSA02..	€ 76,50	KSA00..	€ 72,30
	550x150/2	KSA06.. <td>€ 79,80 <td>KSA04.. <td>€ 74,70</td> </td></td>	€ 79,80 <td>KSA04.. <td>€ 74,70</td> </td>	KSA04.. <td>€ 74,70</td>	€ 74,70
	620x150/2	KSA10.. <td>€ 86,00 <td>KSA08.. <td>€ 79,30</td> </td></td>	€ 86,00 <td>KSA08.. <td>€ 79,30</td> </td>	KSA08.. <td>€ 79,30</td>	€ 79,30
	750x150/2				

Strassenbezeichnungstafeln Ausführung Hohlprofil

Ausführung: Hohlprofil Befestigung: Hohlprofil-Laschen	Maße	Scotchcal-Folie nicht rückstrahlend		Folie Type 1 AEGP rückstrahlend	
		einseitig	beidseitig	einseitig	beidseitig
	550x150mm max. 14 Buchstaben, Schriftgröße: 50 mm	KSH23E..	KSH23B..	KSH22E..	KSH22B..
		€ 54,20	€ 74,60	€ 58,40	€ 96,70
	620x150mm max. 14 Buchstaben, Schriftgröße: 50 mm	KSH27E..	KSH27B..	KSH26E..	KSH26B..
		€ 61,20	€ 77,60	€ 67,00	€ 110,90
750x150mm max. 14 Buchstaben, Schriftgröße: 50 mm	KSH33E..	KSH33B..	KSH32E..	KSH32B..	
	€ 74,40	€ 97,40	€ 77,30	€ 127,90	
Einschubtafel für Nummernangaben Größe 180x60mm		KSH53E..	KSH53B..	KSH52E..	KSH52B..
		€ 26,20	€ 31,60	€ 19,60	€ 24,00

Weitere Größen auf Anfrage!

Für Strassenbezeichnungstafeln gelten folgende Staffelpreise (bei Abnahme in einem Abruf):

ab 20 Stk: -15% Rabatt

50 Stk: -25% Rabatt



Zubehör

Wandbefestigung

auskragend

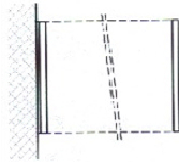

auskragend auf Wand
inkl. 1 seitl. Abdeckung

Tafelhöhe	Best.-Nr Preis
100	KSWA01 € 14,90
150	KSWA02 € 17,00
200	KSWA03 € 19,90

mittig



flach an Wand,
inkl. 2 seitl. Abdeckung

Tafelhöhe	Best.-Nr Preis
100	KSWM01 € 19,00
150	KSWM02 € 19,80
200	KSWM03 € 20,60

Steherbefestigung auskragend

Steher DM 60

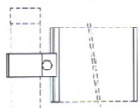

Tafelhöhe 100, 150

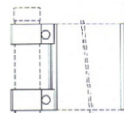

Tafelhöhe 200

Tafelhöhe	Best.-Nr
100	KSSA601 € 20,60
150	KSSA602 € 31,30
200	KSSA603 € 32,00

Steher DM 76

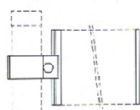

Tafelhöhe 100, 150



Tafelhöhe 200

Tafelhöhe	Best.-Nr
100	KSSA761 € 20,60
150	KSSA762 € 31,30
200	KSSA763 € 42,60

Bandbefestigung

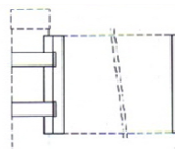

Bandbefestigung
für beliebigen Durchmesser

Tafelhöhe	Best.-Nr
100	KSBA01 € 12,70
150	KSBA02 € 13,40
200	KSBA03 € 14,90



Steherbefestigung mittig

Steher DM 48

einseitig

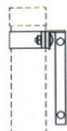

Tafelhöhe

einseitig

100

KSSME481
€ 25,80

150

KSSME482
€ 26,50

200

KSSME483
€ 27,00

Steher DM 60

einseitig

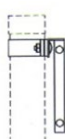

beidseitig

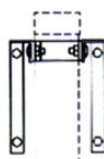

Tafelhöhe

einseitig

beidseitig

100

KSSME601
€ 26,40

KSMD601
€ 34,50

150

KSSME602
€ 26,50

KSMD602
€ 35,90

200

KSSME603
€ 27,10

KSMD603
€ 36,80

Steher DM 76

einseitig

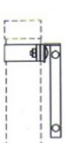

beidseitig

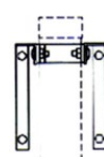

Tafelhöhe

einseitig

beidseitig

100

KSSME761
€ 27,00

KSMD761
€ 35,20

150

KSSME762
€ 27,10

KSMD762
€ 36,30

200

KSSME763
€ 27,70

KSMD763
€ 37,70

Bandbefestigung

einseitig

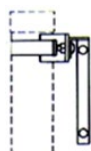

Tafelhöhe

Best.-Nr

100

KSBM01
€ 27,10

150

KSBM02
€ 27,70

200

KSBM03
€ 27,90

Einzelteile für Befestigungslaschen

Verbindungsteil für SSA-Lasche



inkl. Schrauben

Tafelhöhe

Best.-Nr
Preis

100

KSS01
€ 8,80

150

KSS02
€ 11,10

200

KSS03
€ 14,00

SW- Wandbefestigung



inkl. Schrauben

Tafelhöhe

Best.-Nr
Preis

100

KSW01
€ 9,50

150



KSW02
€ 10,30

200

KSW03
€ 12,70

STRASSENBEZEICHNUNGSTAFELN HAUSNUMMERNSCHILDER

Befestigungslaschen für Hohlprofil Schilder

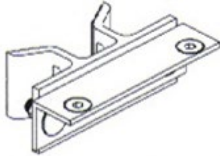
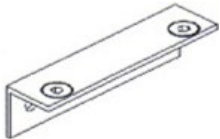
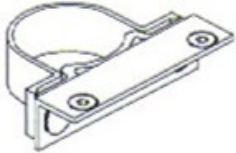
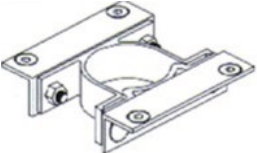
SB-Bandbefestigung		Tafelhöhe	Best.-Nr Preis
 <p>inkl. Schrauben</p>	100	KSB01 € 9,50	
	150	KSB02 € 10,00	
	200	KSB03 € 11,10	
SA - seitliche Abdeckung		Tafelhöhe	Best.-Nr Preis
	100	KSA01 € 5,40	
	150	KSA02 € 6,20	
	200	KSA03 € 6,30	
SSA60 Lasche auskragend		DM	Best.-Nr Preis
 <p>für Befestigung auf Steher DM 60, inkl. Schraube</p>	60	KSSA01 € 10,30	
	76	KSSA02 € 10,30	
SB Lasche für Bandbefestigung			Best.-Nr Preis
 <p>inkl. Schrauben</p>		KSB01B € 23,50	
SWM Lasche für Wandbefestigung		Tafelhöhe	Best.-Nr Preis
 <p>inkl. Schrauben</p>	100	KSWM01 € 19,00	
	150	KSWM02 € 19,80	
	200	KSWM03 € 20,60	
SMB Lasche für Steherbefestigung		DM	Best.-Nr Preis
 <p>mittig, einseitig, inkl. Schrauben</p>	48	KSMB01 € 21,80	
	60	KSMB02 € 21,80	
	76	KSMB03 € 22,80	
SMD Lasche für Steherbefestigung		DM	Best.-Nr Preis
 <p>mittig, beidseitig, inkl. Schrauben</p>	60	KSMD01 € 29,30	
	76	KSMD02 € 30,60	



Hausnummernschilder

Farbauswahl

Grund	Schrift u. Rand	Farbe			Bestellinfo
blau 100-17	weiss 100-10	 1 	Weitere Farben auf Anfrage! Gilt nicht für geprägte Schilder! Standardschrift: Helvetica, weitere Schriften auf Anfrage!		KHAF01A1 = vorletzter Buchstabe ergibt die Randausführung; letzte Zahl ergibt die Farbe
grün 100-122	weiss 100-10	 2 			
weiss 100-10	schwarz 100-12	 5 			

Hausnummer tafeln Ausführung Alu flach

Alu 1,5 mm, inkl. 4 Befestigungslöcher
 Farbauswahl lt. Farbkarte (Sonderfarbe auf Anfrage)
 Bei exaktem Farbton wird ein Musterstück benötigt!



eckig "A"



gerundet "B"



Zierrand "C"

Länge	Scotchcal-Folie nicht rückstrahlend	Folie Type 1 AEGP rückstrahlend
220x150/1,5	KHAF04.. € 36,40	KHAF03.. € 35,00
220x160/1,5	KHAF02.. € 36,40	KHAF01.. € 35,00
240x180/1,5	KHAF12.. € 38,30	KHAF11.. € 37,10

Für Hausnummer tafeln in flacher Ausführung gelten folgende Staffelpreise (bei Abnahme in einem Abruf):
 ab 20 Stk.: -15% Rabatt
 ab 50 Stk.: -25% Rabatt

Hausnummer tafeln mit individuellem Layout, Ausführung Alu flach



Größe	Folie Type 1 AEGP rückstrahlend
220x150 mm	KHNRDIGI01 € 46,60
220x160 mm	KHNRDIGI02 € 46,60
240x180 mm	KHNRDIGI03 € 47,80

Für Hausnummer tafeln mit individuellem Layout gelten folgende Staffelpreise (bei Abnahme in einem Abruf):
 ab 20 Stk.: -15% Rabatt
 ab 50 Stk.: -25% Rabatt

Hausnummer tafeln Ausführung geprägt

Alu 0,5mm, geprägt und 2-färbig einbrennlackiert,
 mit 4 Befestigungslöcher
 mögl. Farbkombinationen:
 1, 2, 5



Typ "A"



Typ "B"

Größe	ungefütert	gefütert
220x160 mm	KHAG01.. Anfrage	KHAG02.. Anfrage
240x180 mm	KHAG11.. Anfrage	KHAG12.. Anfrage

Weitere Größen auf Anfrage!

Hausnummer tafeln Ausführung geprägt und abgeschrägt - auf Anfrage erhältlich!

WIR SETZEN ZEICHEN.

ITEK

Leitpföcke

Ab 01.01.2013 ist die CE-Kennzeichnung für Produkte gemäß ÖNORM EN 12899-3 Voraussetzung für die In-Verkehr-Bringung von Leitpföcken und sämtlicher Komponenten.

Sowohl unsere Leitpföcke als auch unsere Leitpflockreflektoren wurden zertifiziert - auf Wunsch senden wir Ihnen gerne die Zertifikate zu bzw. können Sie diese unter www.itek.co.at einsehen!



Kunststoffleitpflock, gem. RVS 05.02.21 und EN 12899-3

	Länge	Ausführung	Best.-Nr. Preis
	1000*	mit Plastikreflektoren	KLEITKUP1 € 21,80
		mit ITEK-Reflektoren	KLEITKUIT1 € 34,60
		mit Swareflex-Reflektoren	KLEITKUSW1 € 35,10
	1200	mit Plastikreflektoren	KLEITKUP2 € 23,30
		mit ITEK-Reflektoren	KLEITKUIT2 € 36,10
mit Swareflex-Reflektoren		KLEITKUSW2 € 36,60	

* bei Verwendung von Leitpflockfundamentsteinen

Für Leitpföcke gelten folgende Staffelpreise (bei Abnahme in einem Abruf):

- ab 50 Stk. : -20% Rabatt
- ab 100 Stk: -35% Rabatt
- ab 250 Stk: -50% Rabatt

Kunststoffleitpflock mit integrierter Schneestange, gem. RVS 05.02.21 und EN 12899-3

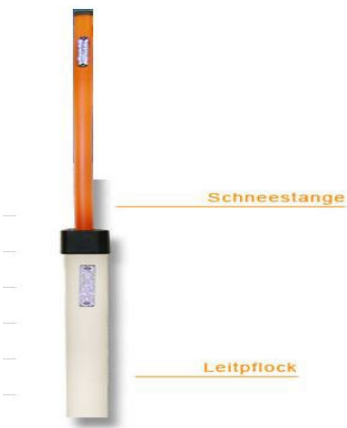
Schneestange: mit Folienstreifen 	Länge	Ausführung	Best.-Nr. Preis
	1000*	mit Plastikreflektoren	KLEITKUPIS1 € 44,80
		mit ITEK-Reflektoren	KLEITKUITIS1 € 61,50
		mit Swareflex-Reflektoren	KLEITKUSWIS1 € 62,20
	1200	mit Plastikreflektoren	KLEITKUPIS2 € 46,20
		mit ITEK-Reflektoren	KLEITKUITIS2 € 63,00
mit Swareflex-Reflektoren		KLEITKUSWIS2 € 63,70	

* bei Verwendung von Leitpflockfundamentsteinen

Für Leitpföcke mit integrierter Schneestange gelten folgende Staffelpreise (bei Abnahme in einem Abruf):

- ab 50 Stk. : -20% Rabatt
- ab 100 Stk: -35% Rabatt
- ab 250 Stk: -50% Rabatt

Sonderausführung: reflektierender Leitpflock

Sichtbare Straßenleiteinrichtung nicht nur am Tag

Neu entwickelter Straßenleitpflock: vollflächig auf 500mm Länge reflektierend (Folie Type 1) und mit speziell bruchsicheren Hochleistungsreflektoren

(Foliengüte Type 3 mit gehärteter Oberfläche und verschweißten seitlichen Rändern) ausgestattet.

Dadurch wird eine saubere und optimale Linienführung bei Tag (optimales Erkennen der roten bzw. weißen Linienführung) und vor allem bei Nacht, Nebel und schlechter Sicht erreicht.

Die neuen Reflektoren entwickeln bereits bei einem Einstrahlwinkel von 5° volle Reflektion - der Vorteil: auch kurvenreiche Straßen sind vom Straßenverlauf optimal sichtbar und vom Fahrzeuglenker wesentlich früher erkennbar.

Kostengünstige Erhaltung:

Durch die besonders glatte Oberfläche wird ein bedeutend höherer selbstreinigender Effekt erreicht als bei herkömmlichen Leitpflöcken.

Geringerer Ausfall:

Durch die sehr gute Sichtbarkeit der Straßenleitpflöcke erreichen wir einen wesentlich geringeren Anteil an Ausfällen durch Unfälle als mit herkömmlichen Straßenleitpflöcken.

reflektierender Kunststoffleitpflock, gem. RVS 05.02.21 und EN 12899-3

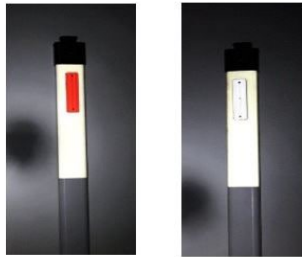

Länge	Ausführung	Best.-Nr. Preis
1000mm*	mit ITEK-Reflektoren	KRLEITKUIT1 € 58,90
1200mm	mit ITEK-Reflektoren	KRLEITKUIT2 € 60,40

* bei Verwendung von Leitpflockfundamentsteinen

Für reflektierende Leitpflöcke gelten folgende Staffelpreise (bei Abnahme in einem Abruf):

ab 50 Stk. : -20% Rabatt

ab 100 Stk: -35% Rabatt

ab 250 Stk: -50% Rabatt

Kunststoffleitpflock mit integrierter Schneestange, gem. RVS 05.02.21 und EN 12899-3

Schneestange: mit Folienstreifen



Länge	Ausführung	Best.-Nr. Preis
1000*	mit ITEK-Reflektoren	KRLEITKUITIS1 € 85,70
1200	mit ITEK-Reflektoren	KRLEITKUITIS2 € 87,20

* bei Verwendung von Leitpflockfundamentsteinen

Leuchtdichte bild

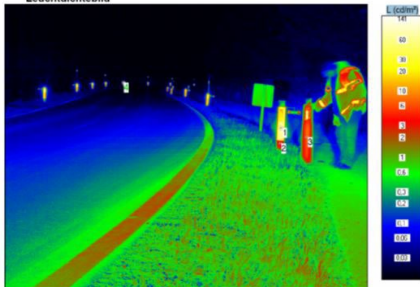

Nr.	Quelle	Reg.	Klass.	Einheit	Anz	Mittel	Sigma	Min	Max	Fläche
1	Leuchtdichtebild 1		Standard	L.cd/m²	213	74,11	5,282	59,44	87,95	213
2	Leuchtdichtebild 2		Standard	L.cd/m²	121	3,848	0,5319	3,096	4,551	121
3	Leuchtdichtebild 3		Standard	L.cd/m²	213	6,171	1,145	3,561	7,839	213
4	Leuchtdichtebild 4		Standard	L.cd/m²	5	31,32	8,298	20,42	39,59	5

Lichttechnisches Gutachten:

Auch nach mehr als einem Jahr Straßeneinsatz ist die Leuchtdichte unserer reflektierenden Leitpflöcke (in ungereinigtem Zustand) mehr als **24x höher** als bei herkömmlichen Leitpflöcken!



Für reflektierende Leitpflöcke mit integrierter Schneestange gelten folgende Staffelpreise (bei Abnahme in einem Abruf):

ab 50 Stk. : -20% Rabatt

ab 100 Stk: -35% Rabatt

ab 250 Stk: -50% Rabatt



Zubehör für Leitpflöcke

ITEK-Hochleistungsreflektor rot

EN 12899-3 zertifiziert
mit 10 Jahre Bruchgarantie



Best.Nr.
Preis/Stk.
KZU12RIT
€ 4,70

ITEK-Hochleistungsreflektor weiss

EN 12899-3 zertifiziert
mit 10 Jahre Bruchgarantie



Best.Nr.
Preis/Stk.
KZU12WIT
€ 4,70

Swareflex-Reflektor rot



Best.Nr.
Preis/Stk.
KZU12RSW
Anfrage

Swareflex-Reflektor weiss



Best.Nr.
Preis/Stk.
KZU12WSW
Anfrage

Abdeckkappe ohne Loch



Best.Nr.
Preis/Stk.
KZU11KU
Anfrage

Abdeckkappe mit Loch DM 65mm



Best.Nr.
Preis/Stk.
KZU12KU
Anfrage

Abdeckkappe für integrierte Schneestange



Best.Nr.
Preis/Stk.
KZU14KU
Anfrage

Leitpflöckfundamentstein - LPF 0

Bauhöhe 360mm
Einschubtiefe 200mm



Best.Nr.
Preis/Stk.
KZU09
€ 58,60

WIR SETZEN ZEICHEN.

ITEK

Schneestangen

Integrierte Schneestange

Vorteile einer integrierten Schneestange:

- geringerer Personalbedarf
- keine Instandhaltungskosten
- kein Lagerplatz
- geringes Gefahrenpotential bei jährlicher Montage bzw. Demontage
- leichtes Nachrüsten von bestehenden Leitpflöcken



Ausführung	Reflektor	Best.-Nr. Preis
Ausführung BASIC** mit Kappe	Folienstreifen	KZU31SVAL € 22,40
Ausführung BASIC** ohne Kappe	Folienstreifen	KZU31SVAL2 € 18,20
Ausführung Haidmaier* mit Kappe	ITEK-Schneestangenreflektor	KZU31ISIT € 50,40
Ausführung Haidmaier* ohne Kappe	ITEK-Schneestangenreflektor	KZU31ISIT2 € 44,90
* 5 Jahre Garantie ** Aufpreis für Schlitz für Sichtzeichen: € 0,40		

Schneestange für Stahlleitschiene (Klappsysteem)

bestehend aus:

- Schneestange mit Länge 1400mm
- Klappsysteem
- Montageset Leitschiene
- inkl. Schrauben



Ausf. BASIC



Ausf. Haidmaier

Ausführung	Reflektor	Best.-Nr. Preis
Ausführung BASIC	Folienstreifen	KZU31SLB € 60,90
Ausführung Haidmaier*	ITEK-Schneestangenreflektor	KZU31SL € 140,70
* 5 Jahre Garantie		

Schneestange für Betonleitwand (Klappsysteem)

bestehend aus:

- Schneestange mit Länge 1045mm
- Klappsysteem
- inkl. Schrauben



Ausf. BASIC



Ausf. Haidmaier

Ausführung	Reflektor	Best.-Nr. Preis
Ausführung BASIC	Folienstreifen	KZU31BSB € 60,90
Ausführung Haidmaier*	ITEK-Schneestangenreflektor	KZU31BS € 103,20
* 5 Jahre Garantie		

Holzschneestange

Länge 2500mm

Farbe: orange/schwarz



Reflektor	Best.-Nr. Preis
ohne Reflektor	KZU32H € 13,90
ITEK-Schneestangenreflektor	KZU32HR € 21,70

Kunststoffschneestange



Reflektor	Best.-Nr. Preis
Folienstreifen	KZU32KU € 21,10

Zusatzzeichen für integrierte Schneestangen

	Ausführung	Best.-Nr. Preis
	gerade 200mm	KZU31ZU20 Anfrage
	Dreieck	KZU31ZUD Anfrage
	Kreuz 2-teilig	KZU31ZUK Anfrage
	komb. Kreuz und Dreieck 2-teilig	KZU31ZUKD Anfrage
	Aufpreis pro Reflektor: ITEK-Schneestangenreflektor	KZU31ZURIT € 3,60

Zubehör für Schneestangen

ITEK-Schneestangenreflektor aus bruchsicherem Kunststoff		
<ul style="list-style-type: none"> - 10 Jahre Bruchgarantie - Material: Lexan 2mm - Maße: 24x125mm 	Farbe	Best.Nr. Preis/Stk.
	rot	KZU181TR € 2,90
	weiss	KZU181TW € 2,90

Schneestangenreflektorfolie in Rolle		
<ul style="list-style-type: none"> - Folie Type 2 HIP - Maße: 25mmx20 lfm 	Farbe	Best.Nr. Preis/Stk.
	rot	KZU18R Anfrage
	weiss	KZU18W Anfrage

Schneestangen-Bodenhülse aus Kunststoff	
<ul style="list-style-type: none"> - 10 Jahre Bruchgarantie - Material: Lexan 2mm - Maße: 24x125mm 	Best.Nr. Preis/Stk.
	KZU20KU € 24,00

Schneestangen-Bodenhülse verzinkt	
- mit Deckel	Best.Nr. Preis/Stk.
	KZU20VZ € 38,50

WIR SETZEN ZEICHEN.

ITEK



Übersicht Spiegel - Spiegeleigenschaften

Spezifikation	Bimex Super Mirror BIMEX	Vereisungsfreier Spiegel BIMEX	Beschlagsfreier Spiegel BIMEX	Edelstahl Spiegel BIMEX	Sicherheitsglas Spiegel BIMEX	Polycarbonat Spiegel BIMEX	Beschlags- und vereisungs-freier Spiegel BASIC Ager	Beschlags- und vereisungs-freier Spiegel DELUXE Ager	Universalspiegel
DM 400									<input checked="" type="checkbox"/>
DM 600	<input checked="" type="checkbox"/>	<input checked="" type="checkbox"/>	<input checked="" type="checkbox"/>	<input checked="" type="checkbox"/>	<input checked="" type="checkbox"/>	<input checked="" type="checkbox"/>	<input checked="" type="checkbox"/>	<input checked="" type="checkbox"/>	<input checked="" type="checkbox"/>
DM 800	<input checked="" type="checkbox"/>	<input checked="" type="checkbox"/>	<input checked="" type="checkbox"/>	<input checked="" type="checkbox"/>	<input checked="" type="checkbox"/>	<input checked="" type="checkbox"/>	<input checked="" type="checkbox"/>	<input checked="" type="checkbox"/>	<input checked="" type="checkbox"/>
DM 1000	<input checked="" type="checkbox"/>	<input checked="" type="checkbox"/>	<input checked="" type="checkbox"/>	<input checked="" type="checkbox"/>					
400x600		<input checked="" type="checkbox"/>	<input checked="" type="checkbox"/>	<input checked="" type="checkbox"/>	<input checked="" type="checkbox"/>	<input checked="" type="checkbox"/>			
600x800		<input checked="" type="checkbox"/>	<input checked="" type="checkbox"/>	<input checked="" type="checkbox"/>	<input checked="" type="checkbox"/>	<input checked="" type="checkbox"/>	<input checked="" type="checkbox"/>	<input checked="" type="checkbox"/>	
800x1000					<input checked="" type="checkbox"/>	<input checked="" type="checkbox"/>	<input checked="" type="checkbox"/>	<input checked="" type="checkbox"/>	
Spiegellinse	Edelstahl	Edelstahl	Edelstahl	Edelstahl	Glas	Polycarbonat	Edelstahl	Edelstahl	Acryl
Spiegelrahmen	Kunststoff	Kunststoff	Kunststoff	Kunststoff Stahl	Kunststoff Aluminium	Kunststoff	Kunststoff	Aluminium	Kunststoff
Eisfrei Gel	<input checked="" type="checkbox"/>	<input checked="" type="checkbox"/>					<input checked="" type="checkbox"/>	<input checked="" type="checkbox"/>	
Hydro Schicht	<input checked="" type="checkbox"/>		<input checked="" type="checkbox"/>						
eisfrei	✓✓✓	✓✓	✓				✓✓	✓✓	
beschlagsfrei	✓✓✓	✓	✓✓✓				✓✓	✓✓	
kratzfest	✓✓	✓✓	✓✓	✓✓	✓✓✓	×	✓✓	✓✓	×
antistatisch	✓✓✓	✓✓✓	✓✓✓	✓✓✓	✓✓✓	×	✓✓✓	✓✓✓	×
schlagfest	✓✓✓	✓✓✓	✓✓✓	✓✓✓	✓	✓✓✓	✓✓✓	✓✓✓	×
rostfrei	✓✓✓	✓✓✓	✓✓✓	✓✓✓	✓✓✓	✓✓✓	✓✓✓	✓✓✓	×
vandalismus-sicher	✓✓✓	✓✓✓	✓✓✓	✓✓✓	✓	✓✓✓	✓✓✓	✓✓✓	×
Sichtqualität	✓✓✓	✓✓✓	✓✓✓	✓✓✓	✓✓✓	✓	✓✓✓	✓✓✓	✓
Ersatzteile	<input checked="" type="checkbox"/>	<input checked="" type="checkbox"/>	<input checked="" type="checkbox"/>	<input checked="" type="checkbox"/>	<input checked="" type="checkbox"/>	<input checked="" type="checkbox"/>	<input checked="" type="checkbox"/>	<input checked="" type="checkbox"/>	keine

Anmerkung:

- ✓✓✓ sehr gut
- ✓✓ gut
- ✓ mittelmäßig
- × schlecht



WIR FÜHREN NUR GUTES IM SCHILDE.

ITEK

Verkehrsspiegel

Verkehrsspiegel mit Kunststoffrahmen



Flexible Halterung
von 48-90mm



Format	Beobachter- abstand (m)	Größe mm	Best.-Nr. Preis
rechteckig	0 - 15	600x400	KVB01K € 290,00
	0 - 20	800x600	KVB02K € 412,90
	0 - 25	1000x800	KVB03K Anfrage
rund	0 - 15	600	KVB01KR € 323,00
	0 - 20	800	KVB02KR € 438,00

Alle Kunststoffspiegel sind mit Sicherheitsglas ausgestattet!

Garantie: 5 Jahre

Verkehrsspiegel mit Aluminiumrahmen



Flexible Halterung
von 48-90mm

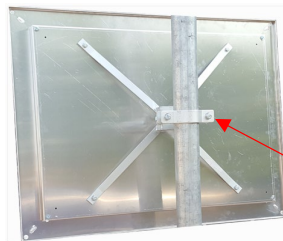

Neigungswinkel stufenlos verstellbar!

Format	Beobachter- abstand (m)	Größe mm	Best.-Nr. Preis
rechteckig	0 - 15	600x400	KVB01A € 524,00
	0 - 20	800x600	KVB02A € 689,30
	0 - 25	1000x800	KVB03A Anfrage

Alle Alu-Spiegel sind mit Sicherheitsglas ausgestattet!

Garantie: 10 Jahre

Universalspiegel



Halterung DM 60mm



Format	Beobachter- abstand (m)	Größe mm	Best.-Nr. Preis
rund	0 - 10	400	KVB01U40 € 106,90
	0 - 15	600	KVB02U60 € 125,50
	0 - 20	800	KVB03U80 € 174,40
Aufpreis für Halterung DM 76mm			KVB01UHT € 15,00

Garantie: 6 Monate

Weitere Spiegel finden Sie auf www.jislon.com

schlagfeste Verkehrsspiegel - vandalismussicher und rostfrei

Ausführung: Polycarbonat mit Kunststoffrahmen



Flexible Halterung
von 48-90mm



Format	Beobachter- abstand (m)	Größe mm	Best.-Nr. Preis
rechteckig	0 - 15	600x400	KVB01V € 312,80
	0 - 20	800x600	KVB02V € 576,20
	0 - 25	1000x800	KVB03V € 690,80
rund	0 - 15	600	KVB01VR € 300,30

Garantie: 5 Jahre

Ausführung: Edelstahl mit Kunststoffrahmen



Flexible Halterung
von 48-90mm

Format	Beobachter- abstand (m)	Größe mm	Best.-Nr. Preis
rund	0 - 15	600	KVB01SR € 393,90
	0 - 20	800	KVB02SR € 550,40
	0 - 25	1000	KVB03SR € 845,90

Garantie: 10 Jahre

Ausführung: Edelstahl vollflächig



Flexible Halterung
von 48-90mm

Format	Beobachter- abstand (m)	Größe mm	Best.-Nr. Preis
rechteckig	0 - 15	600x400	KVB01S € 387,80
	0 - 20	800x600	KVB02S € 525,20

Garantie: 10 Jahre



WIR SETZEN ZEICHEN.



ITEK



Beschlagsfreie Verkehrsspiegel

Ausführung: Edelstahl mit Kunststoffrahmen



Flexible Halterung von 48-90mm

Format	Beobachterabstand (m)	Größe mm	Best.-Nr. Preis
rund	0 - 15	600	KVB01BR € 510,70
	0 - 20	800	KVB02BR € 678,30
	0 - 25	1000	KVB03BR € 989,20
rechteckig	0 - 15	600x400	KVB01B € 625,40
	0 - 20	800x600	KVB02B € 901,00

Garantie: 5 Jahre

Beschlags- und vereisungsfreier Verkehrsspiegel

Ausführung: Edelstahl vollflächig



Flexible Halterung von 48-90mm

Format	Beobachterabstand (m)	Größe mm	Best.-Nr. Preis
rechteckig	0 - 15	600x400	KVB01E € 983,90
	0 - 20	800x600	KVB02E € 1 000,30
	0 - 25	800x1000	KVB03E € 1 240,60

Garantie: 5 Jahre

Ausführung: BASIC mit Kunststoffrahmen

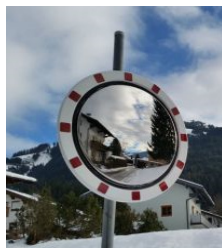

Flexible Halterung von 48-90mm



Format	Beobachterabstand (m)	Größe mm	Best.-Nr. Preis
rechteckig	0 - 15	600x400	KVB01AT1K € 1 066,90
	0 - 20	800x600	KVB01AT2K € 1 234,90
rund	0 - 15	600	KVB01AT3K € 1 122,90
	0 - 20	800	KVB01AT4K € 1 234,90

Diese Spiegel verfügen über eine Edelstahl-Linse mit Kunststoffrahmen

Garantie: 6 Jahre

Ausführung: DELUXE - mit hochwertigem Alurahmen



Flexible Halterung von 48-90mm

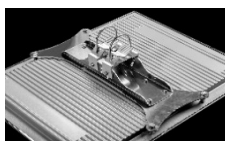

Format	Beobachterabstand (m)	Größe mm	Best.-Nr. Preis
rechteckig	0 - 15	800x600	KVB01AT2 € 1 514,90
	0 - 20	800x1000	KVB01AT3 € 1 906,90

Diese Spiegel verfügen über eine Edelstahl-Linse mit hochwertigem Alurahmen

Garantie: 6 Jahre

Jislon - BIMEX Super Mirror - Beschlags- und vereisungsfreie Spiegel

mit spezieller Beschichtung - bis zu 99%iger Wirkungsgarantie



Flexible Halterung von 48-90mm

Format	Beobachterabstand (m)	Größe mm	Best.-Nr. Preis
rund	0 - 15	600	KVB01BSM € 899,50
	0 - 20	800	KVB02BSM € 1.161,50
	0 - 25	1000	KVB03BSM € 1.448,20

Diese Spiegel verfügen über eine Edelstahl-Linse mit Kunststoffrahmen

Garantie: 5 Jahre



Schnee



Regen



Nebel

Perfekte Kombination von beschlagsfreien und vereisungsfreien Spiegeln!

Die Spiegeloberfläche garantiert beste Sichtbarkeit bei allen Wetterlagen.

Klare Sicht bei Nebel, Bewölkung, Regen, Schnee, Frost.

Der Spiegel benötigt nur etwas Regen und UV-Licht für optimale Funktionalität.

Selbstreinigende Funktion: durch die spezielle Oberflächenbeschichtung reinigt sich der Spiegel durch Regen und UV-Licht.

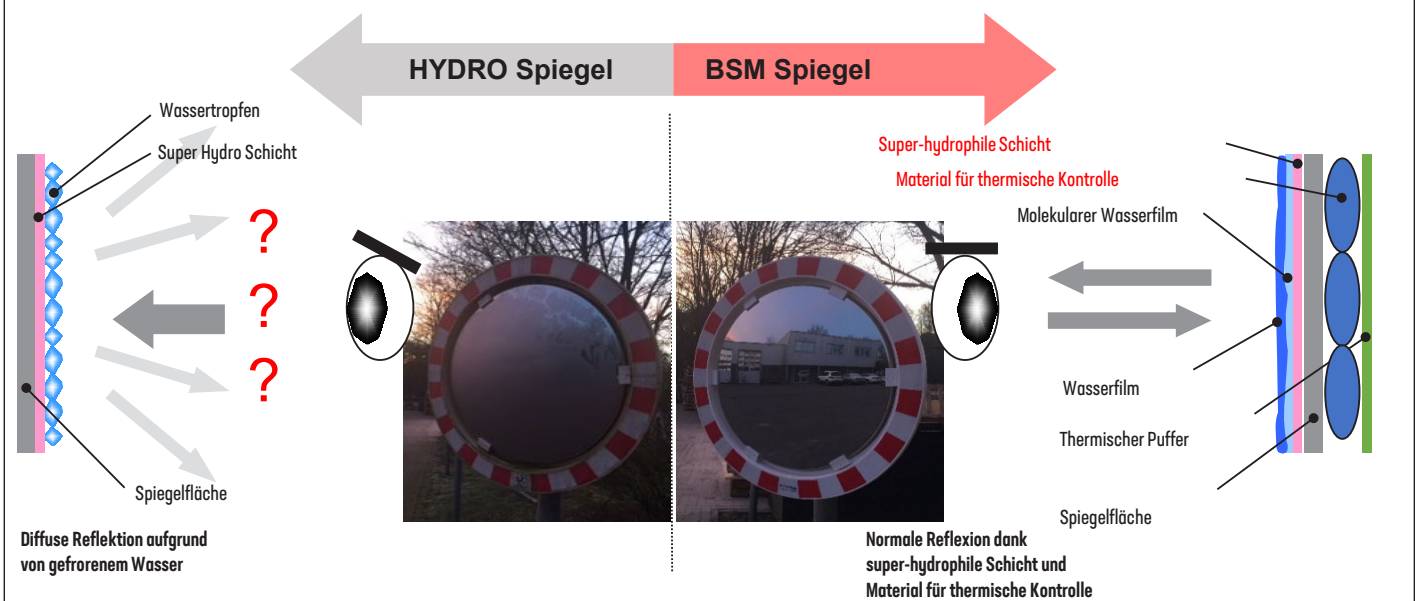

SPIEGEL

Befestigungsmaterial

Spiegel-Zubehör

Steher innen und aussen feuerverzinkt



Länge	DM 48mm	DM 60mm	DM 60mm	DM 76mm
	2,0mm WS	2,0mm WS	3,0mm WS	3,0mm WS
3000	KRS51V	KRS52V	KRS53V	KRS54V
	€ 48,80	€ 54,40	€ 86,90	€ 91,10
3500	KRS61V	KRS62V	KRS63V	KRS64V
	€ 55,10	€ 62,00	€ 99,50	€ 104,40
4000	KRS71V	KRS72V	KRS73V	KRS74V
	€ 61,30	€ 72,50	€ 112,10	€ 117,60

Wandarm (Ausführung ALU)

geschweißte Ausführung



DM	Best.-Nr. Preis
76	KVB01W € 147,50

Gabelaufsatz

geschweißte Ausführung

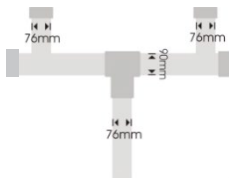

für Spiegelgr.	Best.-Nr. Preis
600x400	KVB11G € 206,70
	KVB12G € 210,90
800x600	KVB13G € 223,10
	KVB14G € 223,10

Spiegelheizung mit Thermostat

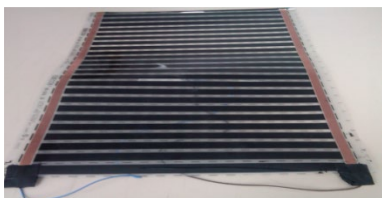

für Spiegelgr.	Best.-Nr. Preis
800x600	KVBE02HZ Anfrage
	KVBE03HZ Anfrage
1000x800	KVBE04HZ Anfrage
1200x1000	KVBE05HZ Anfrage

Ersatzteile (wie Spiegellinsen, Ersatzglas usw.) auf Anfrage!



WIR SETZEN ZEICHEN.

ITEK



Allgemeine Informationen

Produkteigenschaften

- Richtet sich wieder auf, wenn er überfahren wird - auch bei Schwerlastverkehr!
- Einfache Installation
- Sehr wetter- und witterungsbeständig auch bei extrem hohen und niedrigen Temperaturen
- Qualitativ hochwertiges und langlebiges Polyurethan
- Beständig gegen Salz und Säuren
- TÜV-zertifiziert und CE-gekennzeichnet - entspricht daher der EN 12899

😊 = innerhalb von 15 Arbeitstagen lieferbar

Montagemöglichkeiten

NS- und NSE-Poller

1. Schrauben Sie die Bodenhülse beim Poller fest mit dem Schlüssel an.
2. Bohren Sie ein Loch.
3. Reinigen Sie das Loch und die Oberfläche.
4. Applizieren Sie den 2-Komponenten-Epoxid-Kleber.
5. Drücken Sie den Poller in den Kleber ein.
6. Lassen Sie den Kleber aushärten - während der Aushärtephase darf der Poller nicht bewegt werden!
7. Schrauben Sie den Poller mit dem dazugehörigen Pollerschlüssel fest.

NS Anker (austauschbar)

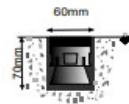

NSE Anker (Fest)

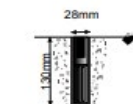

NF (Fest)



NF-Poller

1. Reinigen Sie die Bodenfläche.
2. Applizieren Sie den 2-Komponenten-Epoxid-Kleber.
3. Drücken Sie den Poller in den Kleber ein.
4. Lassen Sie den Kleber aushärten - während der Aushärtephase darf der Poller nicht bewegt werden!



POLLER

Überfahrbare Absperrpfosten

Gegenüberstellung Jislon-Poller - Billig-Poller

Gerade im Pollerbereich gibt es unzählige Billig-Produkte - die sich rein optisch von hochwertigen Pollern kaum unterscheiden. Aber schon nach kurzer Zeit merken Sie den Unterschied - sehen Sie sich die u.a. Bilder an und entscheiden Sie selbst:



Standfestigkeit:
Wir garantieren aufrechte Poller
- auch nach langer
Einsatzdauer!



Farbechtheit:
Wir garantieren Farbechtheit
auch nach langer Einsatzdauer!



Überfahrbarkeit:
Bis zu 1000x problemlos
überfahrbar - getestet und
zertifiziert!



CE-geprüft und daher EN 12899-konform

Gemäß EN 12899 müssen alle Produkte, die länger als 1 Jahr im öffentlichen Bereich verbaut werden, CE-geprüft sein. Unsere Poller sind CE-geprüft und entsprechen der EN 12899 - auf Wunsch senden wir Ihnen gerne das Zertifikat zu!

Auch nach langer Einsatzdauer:

kein Umknicken, kein Farbverlust, 100%ige Funktionsgarantie

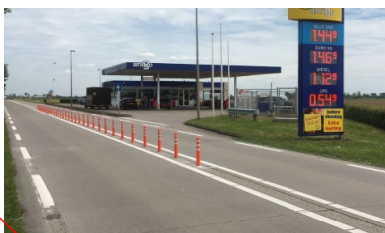

WIR SETZEN ZEICHEN.

ITEK

POLLER

Überfahrbare Absperrpfosten

Fahrbahnpoller

Poller NS - zum Verschrauben, austauschbar

Standardfarbe: orange

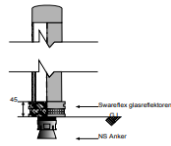
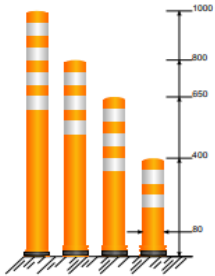

Höhe	DM	Best.-Nr. Preis
400	80	KPC40NSR € 127,10
650	80	KPC60NSR € 153,90
800 😊	80	KPC80NSR € 176,60
1000 😊	80	KPC100NSR € 203,40

weitere Farben



Farbe	Höhe	DM	Best.-Nr. Preis
weiss-rot	800	80	KPC80NSWR € 179,70
	1000 😊	80	KPC100NSWR € 206,50
weiss-weiss	800 😊	80	KPC80NSWW € 179,70
	1000	80	KPC100NSWW € 206,50
schwarz-weiss	400	80	KPC40NSSW € 127,10
	800 😊	80	KPC80NSSW € 176,60
schwarz-gelb	400	80	KPC40NSSG € 127,10
	800 😊	80	KPC80NSSG € 176,60
weiss-blau	1000	80	KPC100NSWB € 219,90

Mindestabnahme: 5 Stück

Poller NF - zum Verkleben

Standardfarbe: orange

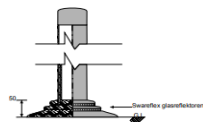
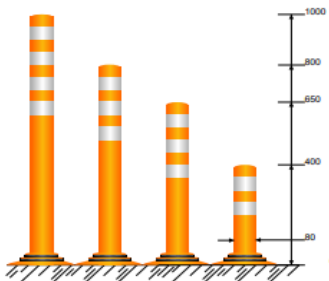

Höhe	DM	Best.-Nr. Preis
400	80	KPC40NFR € 169,40
650	80	KPC60NFR € 193,10
800	80	KPC80NFR € 217,80
1000	80	KPC100NFR € 247,70

Mindestabnahme: 5 Stück

weitere Farben



Farbe	Höhe	DM	Best.-Nr. Preis
schwarz-weiss	800 😊	80	KPC80NFGSW € 217,80
	800 😊	80	KPC80NFGSG € 217,80

Mindestabnahme: 5 Stück



POLLER

Überfahrbare Absperrpfosten

Poller NSE - zum Verschrauben, fest, nicht austauschbar

Standardfarbe: orange

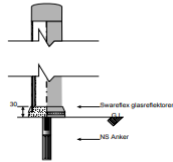
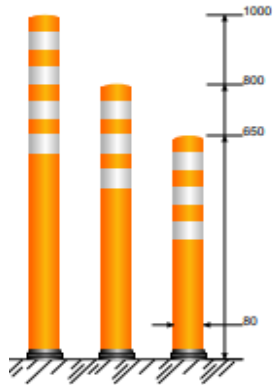

Höhe	DM	Best.-Nr. Preis
650	80 😊	KPC60NSE € 117,80
800	80 😊	KPC80NSE € 136,40
1000	80	KPC100NSE € 166,30

weitere Farben

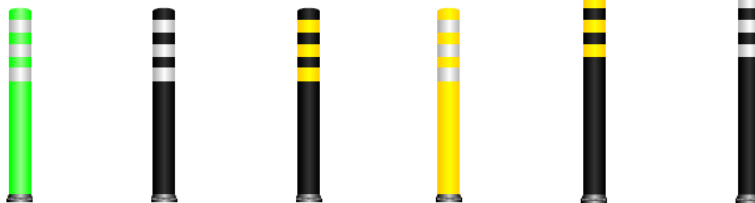

Farbe	Höhe	DM	Best.-Nr. Preis
grün-weiss	800	80	KPC80NSEGRW € 136,40
schwarz-weiss	800	80	KPC80NSESW € 136,40
	1000	80	KPC100NSESW € 194,10
schwarz-gelb	800 😊	80	KPC80NSESG € 136,40
	1000	80	KPC100NSESG € 166,30
gelb-weiss	800	80	KPC80NSEGW € 136,40

Mindestabnahme: 5 Stück



SCHILDER VON WELT MIT UMWELTEFFEKT.

IT&K

POLLER

Überfahrbare Absperrpfosten

Stadtpoller

Modell DK-7BS - zum Verschrauben, austauschbar

Standardfarbe: anthrazit

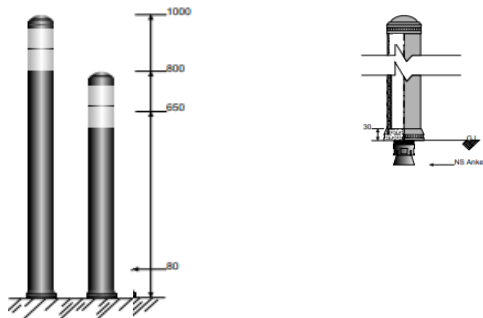

Höhe	DM	Best.-Nr. Preis
800 😊	80	KDK7BSM80 € 202,70
1000 😊	80	KDK7BSM100 € 223,90

Ideal zum Kombinieren:

Poller mit Ösen und Absperrketten - für den eleganten Look!

Hier empfehlen wir die verstärkte Poller-Ausführung! Preis auf Anfrage!



weitere Farben



Farbe	Höhe	DM	Best.-Nr. Preis
grün-weiss	800	80	KDK7BSM80GR € 202,70

Mindestabnahme: 5 Stück

Modell DK-7NSE - zum Verschrauben, fest, nicht austauschbar

Standardfarbe: anthrazit

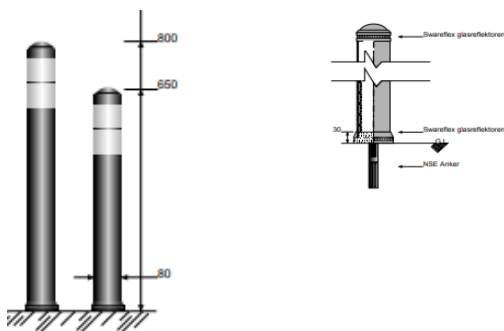

Höhe	DM	Best.-Nr. Preis
650	80	KDK7NSEM65NST € 151,70
800 😊	80	KDK7NSEM80 € 190,00

Mindestabnahme: 5 Stück



DIGITALDRUCK MACHT EINDRUCK.



ITEK



POLLER

Überfahrbare Absperrpfosten

Modell DK-7 Kugelkopf - zum Verschrauben, austauschbar

Standardfarbe: schwarz-weiss

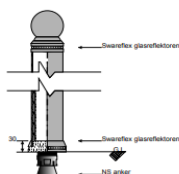
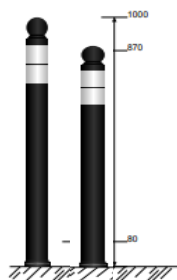

Farbe	Höhe	DM	Best.-Nr. Preis
schwarz-weiss	870	80	KDK7BSM80BSW € 228,20
	1000 😊	80	KDK7BSM100BSW € 240,90

Mindestabnahme: 5 Stück



Ideal zum Kombinieren:

Poller mit Ösen und Absperrketten - für den eleganten Look!

Hier empfehlen wir die verstärkte Poller-Ausführung! Preis auf Anfrage!

weitere Farben

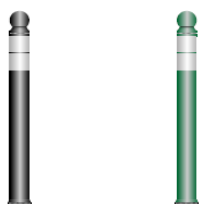

Farbe	Höhe	DM	Best.-Nr. Preis
anthrazit-weiss	870 😊	80	KDK7BSM80BAW € 228,20
grün-weiss	870	80	KDK7BSM80BGRW € 228,20

Mindestabnahme: 5 Stück

Modell DK-7 Edelstahl - zum Verschrauben, austauschbar

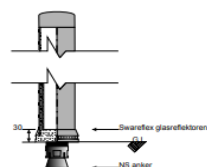
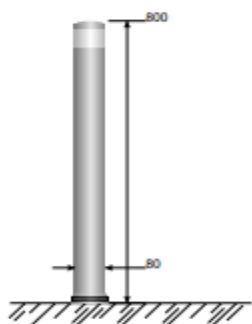

Farbe	Höhe	DM	Best.-Nr. Preis
Edelstahl optik	800	80	KDK7BSM80E € 223,90

Mindestabnahme: 5 Stück

Modell DK-7 mit LED Marker

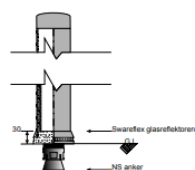
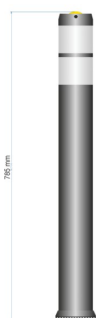

Farbe	Höhe	DM	Best.-Nr. Preis
anthrazit LED weiss	800	80	KDK7BSM80LEDW € 412,90

Mindestabnahme: 5 Stück

Weitere LED-Farben auf Anfrage!

Modell DK-8 - zum Verschrauben, austauschbar

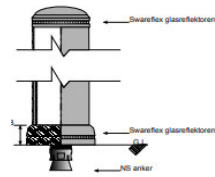
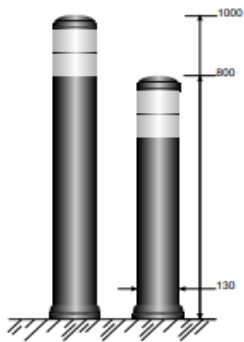

Farbe	Höhe	DM	Best.-Nr. Preis
anthrazit	800 😊	130	KDK8BSM80 € 270,70
	1000 😊	130	KDK8BSM100 € 299,30

Mindestabnahme: 5 Stück

Weitere Anwendungsmöglichkeiten:

- mit individuellen Folien verklebt - Preis auf Anfrage!

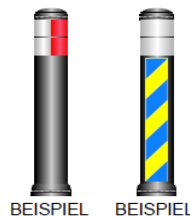

Modell DK-8 mit Ringkopf - zum Verschrauben, austauschbar

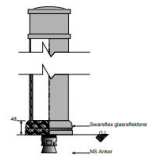
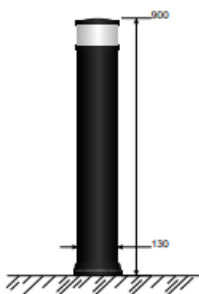

Farbe: schwarz

Höhe	DM	Best.-Nr. Preis
900 😊	130	KDK8BSM90R € 309,90

Mindestabnahme: 5 Stück

Weitere Anwendungsmöglichkeiten:

mit individuellen Folien verklebt
Preis auf Anfrage



Modell DK-9 mit Ringkopf, mit Stahlrohr - fest, nicht austauschbar, aus Vollgummi - anfahrbar, aber nicht überfahrbar

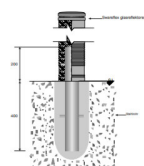

Farbe: anthrazit

Höhe	DM	Best.-Nr. Preis
800	130	KDK9BSM80 € 315,20

Mindestabnahme: 5 Stück



POLLER

Überfahrbare Absperrpfosten

Modell DK-10 - mit Stahlrohr - fest, nicht austauschbar, aus Vollgummi - anfahrbar, aber nicht überfahrbar

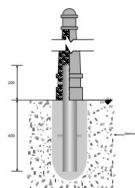

Farbe	Höhe	DM	Best.-Nr. Preis
anthrozit	800	130	KDK10BSM80 € 268,50

Mindestabnahme: 5 Stück

Sonstige Poller

LS Modell

Ausführung: nicht reflektierend

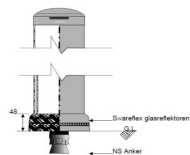
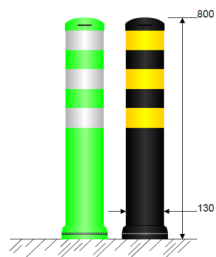

Farbe:	Höhe	DM	Best.-Nr. Preis
grün-weiss	800	130	KPC80LSGRW € 228,10
schwarz-weiss	800 ☺	130	KPC80LSSW € 228,10
schwarz-gelb	800 ☺	130	KPC80LSSG € 228,10
rot-weiss	800 ☺	130	KPC80LSRW € 249,80
gelb-weiss	800	130	KPC80LSGW € 228,10

Mindestabnahme: 5 Stück

Ausführungsvarianten:

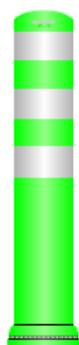

POLLER

Überfahrbare Absperrpfosten

Guide-Modell



Farbe:	Höhe	DM	Best.-Nr. Preis
orange	800	80	KPCGUIDEOR80 € 149,20
		130	KPCGUIDEOR130 € 199,30
schwarz	800	80	KPCGUIDESCHW80 € 149,20
		130	KPCGUIDESCHW130 € 199,30
Leitwinkel-Folie Type 2 (rot-weiss), Preis pro Stück			KPCGUIDEFOLLW € 20,90

Mindestabnahme: 5 Stück

Ausführungsvarianten: individuelle Reflektorfolien gegen Aufpreis!



Poller für Verkehrszeichen - anfahrbar

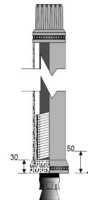
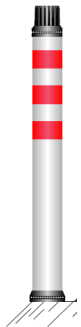

Farbe	Ausführung	Höhe	DM	Best.-Nr. Preis
rot-weiss	NS	832 😊	80	KPCSIGN80RW € 283,80
Preisangabe gilt nur für Poller - Zubehör wie Verkehrszeichen, Steher und Laschen nicht inkludiert				

Mindestabnahme: 5 Stück



POLLER

Überfahrbare Absperrpfosten

Poller für Leitwinkel



Farbe	Höhe	DM	Best.-Nr. Preis
NS	800	80	KPC80NSRLW € 318,20
	1000	80	KPC100NSRLW € 334,50
Preisangabe gilt für Poller inkl. 2 Top-Parts und Leitwinkel sowie Kleber			
Leitwinkel	Gr. 200x600mm	Lexan 3mm	KFLLW01 € 85,10

Solar Base Leitschwelle

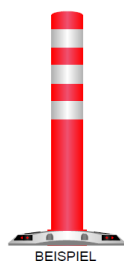

BEISPIEL

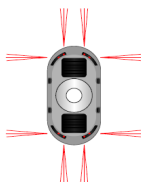
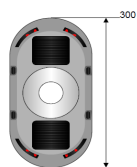

Maße in mm BxH	Ausführung	Best.-Nr. Preis
300x150x40	doppelseitig rot/weiss	KZUSBBS € 264,60
	einseitig rot	KZUSBESR € 176,40
	einseitig weiss	KZUSBESW € 176,40

Etliche Modelle können auch in verstärkter oder sogar extra starker Ausführung (mit Innenrohr) ausgeführt werden - Preis und Lieferzeit auf Anfrage!

Weitere Poller finden Sie auf www.jislon.com

WIR SETZEN ZEICHEN.

ITEK

Ersatzteile und Zubehör

Einbauschlüssel	
passend für NS-, NSE und DK7-Modelle	Best.Nr. Preis/Stk.
	KPCSCHLSR € 31,80

Einbauschlüssel	
passend für LS und DK87-Modelle	Best.Nr. Preis/Stk.
	KPCSCHLSRLS € 54,90

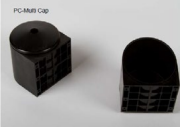
Top-Part	
passend für NS-, NSE-,DK-7-Modelle	Best.Nr. Preis/Stk.
	KPCTOPPART € 20,30

Bodenplatte mit Dreikantverschluss		
passend für NS-, NSE-,DK-7-Modelle	Ausführung	Best.Nr. Preis/Stk.
	Bodenplatte	KPCDREIKANT € 197,50
	Dreikant-schlüssel	KPCDREIKANTSCHL € 10,00

Bodenhülse	
passend für NS-, DK7-, LS- und DK-8 Modelle	Best.Nr. Preis/Stk.
	KPCBHA € 17,50

Bodenhülse		
passend für NSE-Modelle	Ausführung	Best.Nr. Preis/Stk.
	Alu-Ausführung	KPCBHALU € 11,60
	Stahl-Ausführung	KPCBHBSTAHL € 13,20

Abdeckkappen	
passend für NS-, DK7-, LS- und DK-8 Modelle aus Vollgummi	Best.Nr. Preis/Stk.
	KPCCAPA € 5,30

Abdeckkappen	
passend für NS-, DK7-, LS- und DK-8 Modelle Schraube und Dichtungsring	Best.Nr. Preis/Stk.
	KPCCAPB € 28,90

Einbaustärker Modell SP	
passend für NS-, NSE-,DK-7-Modelle	Best.Nr. Preis/Stk.
	KPCNSANCHORSP € 22,90

Einbaustärker Modell GA	
passend für NS-, NSE-,DK-7-Modelle Länge: 270mm	Best.Nr. Preis/Stk.
	KPCNSANCHORGA Anfrage

Kleber	
für ein rasches Einkleben der Bodenhülse 2,5 kg/Kübel ausreichend für ca. 5 Poller	Best.Nr. Preis/Stk.
	KPCKLEB € 30,50

2-Komponenten-Kleber	
für ein rasches Einkleben der Bodenhülse speziell bei NSE-Poller	Best.Nr. Preis/Stk.
	KPCKLEBB Anfrage

POLLER

Flexible Zonen-/Fahrbahnteilungen

Elastikpoller aus Vollgummi - anfahrbar, nicht überfahrbar



Farbe	Höhe	DM	Best.-Nr. Preis
anthrazit - weiß	1400	140	K812200 € 299,90

Mindestabnahme: 5 Stück

Reflexbänder auch in anderen Farben möglich - Preis auf Anfrage!



Trenninsel - perfekt mit Poller kombinierbar

Preis inkl. Befestigungsset
Preis ohne Poller



Bezeichnung	Farbe	Maße	Best.-Nr. Preis
Anfangs-/Endstück	asphaltgrau-weiß	600x900	KSAFISLA € 334,60
Mittelstück	asphaltgrau	600x600	KSAFISLB € 309,60
Befestigungsset			KSAFISLBEF € 45,50

Kombinationsmöglichkeiten:



Mile-Stone - Trennbalken

Preis inkl. Befestigungsset
Preis ohne Poller
passend für Poller DM 80 und 130mm
Ausführung mit LED-Marker auf Anfrage!



Farbe	Maße	Best.-Nr. Preis
asphaltgrau-weiß	250x1000x85	KPCMILESTONE € 204,80
Glaskörper		KPCGLASK € 53,80

Euronormkissen, Berliner Kissen

- in anthrazit oder rotbraun erhältlich
- kostengünstige, schnelle und wirksame Einrichtung von Plateau-Aufpflasterungen
- geräuscharm durch Gummiaufbau
- variable Größen
- leichte Montage
- praxisbewährt
- eignet sich besonders innerhalb von 30-50 Zonen sowie an Knotenpunkten
- sichtbar durch Retroreflektion



Preis auf Anfrage

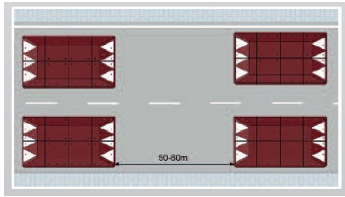

Um die Geschwindigkeit auf einem längeren Streckenbereich gleichmäßig zu reduzieren, sollte der Abstand der Kissen zwischen 50 und 80 Meter betragen.



Minikreissegmentschwelle - DM 3000mm

- in anthrazit oder rotbraun erhältlich
- setzt sich aus 8 Kreissegmentschwellen zusammen
- langlebig
- geräuscharm durch Gummiaufbau
- leichte Montage
- praxisbewährt
- sichtbar durch Retroreflektion

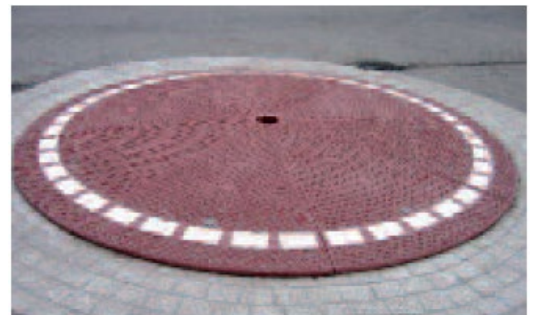

Preis auf Anfrage

WIR FÜHREN NUR GUTES IM SCHILDE.

ITEK

Signalschwelle

- leichte Montage
- variable Größen
- sichtbar durch Retroreflektion
- kostengünstig
- praxisbewährt
- eignet sich besonders für Parkplätze, Ausfahrten, Wohngebiete, unbeschränkten Bahnübergängen



Preis auf Anfrage

Überfahrgeschwindigkeit	Breite x Höhe	Länge
bis 10 km/h	355 x 55	variabel
bis 15 km/h	900 x 70	variabel
bis 20 km/h	600 x 50	variabel
bis 30 km/h	900 x 50	variabel



Elastikbordstein

- in anthrazit oder rotbraun erhältlich
- kostengünstig
- geräuscharm durch Gummiaufbau
- variabel in Größe und Farbe
- leichte Montage
- praxisbewährt
- eignet sich besonders für Verkehrsinseln, Fußgängerübergängen, Bordsteinerhöhungen, Geh- und Radwegen
- sichtbar durch Retroreflektion



Preis auf Anfrage



Parkplatzstopp

- in anthrazit-weiss oder anthrazit-gelb erhältlich
- kostengünstig
- leichte Montage
- praxisbewährt
- sichtbar durch Retroreflektion
- eignet sich besonders für Sperrflächen, Parkplatzbegrenzungen

Preis auf Anfrage



Trenn- und Markierungsbalken

- in anthrazit oder rotbraun erhältlich
- kostengünstig
- leichte Montage
- praxisbewährt
- sichtbar durch Retroreflektion
- eignet sich besonders zur Abgrenzung von Geh- und Radwegen

Preis auf Anfrage



SCHILDER VON WELT MIT UMWELTEFFEKT.

ITEK

Geschwindigkeitsanzeigergeräte

Type REFLECTOR



Pocket

Compact

Cube



Type	Anzeige	Größe mm	Best.-Nr. Preis
Pocket Reflector	2-stellig, bis max. 99 km/h	500x500	KPOCKETREFL € 2.038,80
Compact Reflector	3-stellig, bis max. 199 km/h	700x500	KCOMPREFL € 2.294,80
Cube Reflector	3-stellig, bis max. 199 km/h	700x700	KCUBEREFL € 2.550,80

Type TACHO



Compact - Hoch- oder Querformat



Cube



Grand



Square



Giant



Type	Anzeige	Größe mm	Best.-Nr. Preis
Compact Tacho Hochformat	2-stellig, bis max. 99 km/h	500x700	KCOMPTACHO € 2.114,30
Compact Tacho Querformat	2-stellig, bis max. 99 km/h	700x500	KCOMPTACHOQU € 2.114,30
Cube Tacho	3-stellig, bis max. 199 km/h	700x700	KCUBETACHO € 2.550,80
Grand Tacho	3-stellig, bis max. 199 km/h	700x1000	KGRANDTACHO € 2.806,80
Square Tacho	3-stellig, bis max. 199 km/h	900x900	KSQUARETACHO € 2.934,80
Giant Tacho	3-stellig, bis max. 199 km/h	900x1250	KGIANTTACHO € 3.190,80

Textoption: "Hier gilt" gegen Aufpreis!

Type COMMANDER



Compact - Hoch- oder Querformat



Cube



Grand



Square



Giant



Type	Anzeige	Größe mm	Best.-Nr. Preis
Compact Commander Hochformat	2-stellig, bis max. 99 km/h	500x700	KCOMPCOMM € 2.648,00
Compact Commander Querformat	2-stellig, bis max. 99 km/h	700x500	KCOMPCOMMQU € 2.545,60
Cube Commander	3-stellig, bis max. 199 km/h	700x700	KCUBECOMM € 3.121,60
Grand Commander	3-stellig, bis max. 199 km/h	700x900	KGRANDCOMM € 2.934,80
Square Commander	3-stellig, bis max. 199 km/h	900x900	KSQUARECOMM € 3.179,20
Giant Commander	3-stellig, bis max. 199 km/h	900x1250	KGIANTCOMM € 3.896,00

Weitere ausführliche Informationen finden Sie auf www.wavetec-online.de!

Achten Sie darauf, den Akku stets korrekt zu lagern: Bei Zwischenlagerungen muss die Batterie **IMMER** vollständig aufgeladen sein. Denken Sie daran, dass extreme Temperaturen (Kälte oder Wärme) den Akku entladen können. Bei einer Tiefentladung kann der Akku unbrauchbar werden.

Bitte kontrollieren Sie den Akku alle 6 Monate!

Type REMINDER



Type	Anzeige	Größe mm	Best.-Nr. Preis
Compact Reminder	2-stellig, bis max. 99 km/h	500x700	KCOMPREM € 2.550,80
Cube Reminder	3-stellig, bis max. 199 km/h	700x700	KCUBEREM € 2.806,80
Grand Reminder	3-stellig, bis max. 199 km/h	700x900	KGRANDREM € 3.190,80
Square Reminder	3-stellig, bis max. 199 km/h	900x900	KSQUAREREM € 3.446,80
Giant Reminder	3-stellig, bis max. 199 km/h	900x1250	KGIANTREM € 3.830,80

Type LIMITER

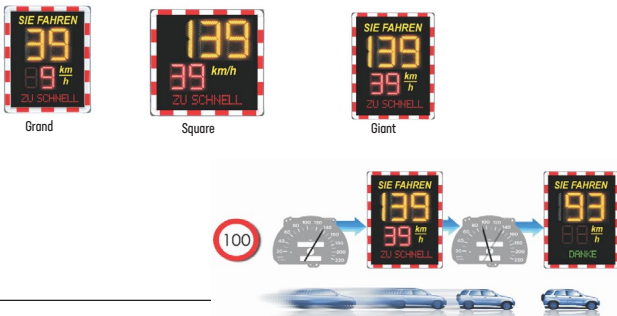

Type	Anzeige	Größe mm	Best.-Nr. Preis
Grand Limiter	2-stellig, bis max. 99 km/h	700x900	KGRANDLIM € 3.800,00
Square Limiter	3-stellig, bis max. 199 km/h	900x900	KSQUARELIM € 4.056,00
Giant Limiter	3-stellig, bis max. 199 km/h	900x1250	KGIANTLIM € 4.440,00

Type EMOTICA und UP

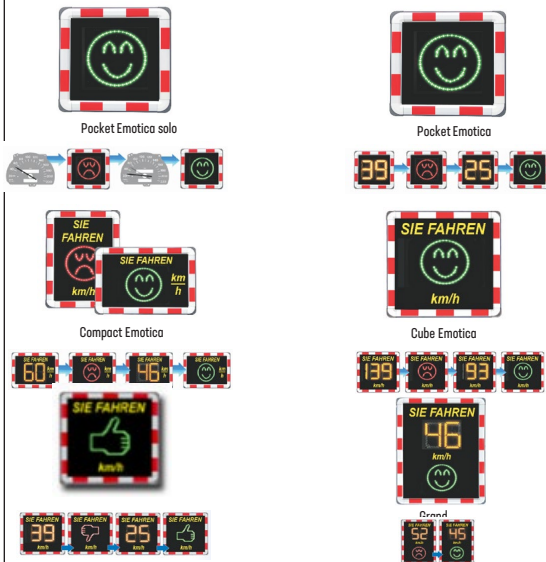





Type	Anzeige	Größe mm	Best.-Nr. Preis
Pocket Emotica solo	nur Symbolanzeige	500x500	KPOCKEMOTSOLO € 2.038,80
Pocket Emotica	2-stellig, bis max. 99 km/h, +Symbolanzeige	500x500	KPOCKEMOT € 2.166,80
Compact Emotica Hochformat	2-stellig, bis max. 99 km/h, +Symbolanzeige	500x700	KCOMPEMOTICA € 2.294,80
Compact Emotica Querformat	2-stellig, bis max. 99 km/h, +Symbolanzeige	700x500	KCOMPEMOTICAQU € 2.294,80
Cube Emotica	3-stellig, bis max. 199 km/h, +Symbolanzeige	700x700	KCUBEEMOTICA € 2.678,80
Cube Up	3-stellig, bis max. 199 km/h, +Symbolanzeige	700x700	KCUBEUP € 2.678,80
Grand Emotica	2-stellig, bis max. 99 km/h, +Symbolanzeige	700x900	KGRANDEMOTICA € 2.744,00

Display-Optionen

Farbwechseloption	für 250mm Zifferndisplays	gelb/rot	KAPZ250GR € 224,00	LED-Symbole	Gesichtssymbol	für 250mm Zifferndisplays	KAPG250 € 178,00
		grün/rot	KAPZ250GRR € 224,00			Daumensymbol	für 300 mm Zifferndisplays
für 300 mm Zifferndisplays	gelb/rot	KAPZ300GR € 268,80	für 300 mm Zifferndisplays	KAPD300 € 216,40			
	grün/rot	KAPZ300GRR € 268,80					
für 400 mm Zifferndisplays	gelb/rot	KAPZ400GR € 313,60	Aufpreis für LED-Zusatztexte auf Anfrage!				
	grün/rot	KAPZ400GRR € 313,60					

Energieversorgung						
Energiepaket 230 V		220x230 V AC Anschluss inkl. Anschlusskabel	KVVENERGIE_V € 253,50	Zum Nachrüsten:		
				Energiepaket Laterne	Nachrüstoption bei vorhandenem Akku	KVVENERGIE_L_EX € 377,60
Akku Energiepaket 12 V, 18 Ah		Akku 12 V 18 Ah, inkl. Gehäuse und Ladegerät	KVVENERGIE_A2 € 280,40	Solarbox 12V 18 Ah 50W	Externe Solarbox mit Akku 12V 18 Ah + 50W Solarpaneel (für Display-Geräte 70x50 oder 50x70 geeignet)	KWVSOLARBOX_L € 697,60
		2x Akku 12 V 18 Ah, inkl. Metallgehäuse und Ladegerät	KVVENERGIE_A3 € 421,20			
Energiepaket Laterne		230V AC Anschlussleitung für Laternenbetrieb + Akku 12V 18Ah inkl. Gehäuse und Ladegerät	KVVENERGIE_L+ € 505,60	Solarbox 12V 18 Ah 90W	Externe Solarbox mit Akku 12V 18 Ah + 90W Solarpaneel (für Display-Geräte 70x70 geeignet)	KWVSOLARBOX_XL € 1.081,60
Energiepaket Solar		Solarpaneel 50W inkl. Halterung für Display-Geräte 50x70 oder 70x50 geeignet nur in Kombination mit Akku sinnvoll	KVVENERGIE_S5+ € 697,60	◊		○
		Solarpaneel 90W inkl. Halterung für Display-Geräte 70x70 geeignet nur in Kombination mit Akku sinnvoll	KVVENERGIE_S9+ € 1.081,60			

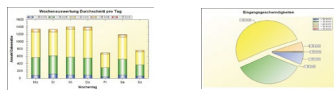
Halterungen/Befestigungsmaterial					
Laschen		2x KCE60-Lasche samt Neigungsprofil	KWVLASCHE € 44,80	Masten	MOMA mobiler Universalsteckmast KVMOMA € 633,60
Universalbandschelle		für DM 40-250mm mit Stahlband	KWV2A_SCHELLE € 114,60	Griff	TRIMA mobiler Dreibeinmast KVVTRIMA € 242,00
		für DM 40-250mm mit Stahlband und Einhängelasche	KWV2A_MOBIL € 126,80		
Schnelleinhängvorrichtungen		MAPAT	KWVMAPAT € 178,00	Transportkoffer	Aluminiumgriff 2x zur seitlichen Montage KVVAP-GRIFF_1 € 249,60
		MAEASY	KWVMAEASY_UNI € 191,40		Aluminiumgriff 1x zur Montage an der oberen Seite KVVAP-GRIFF_2 € 158,40
		MAMOBIL	KWVMAMOBIL € 300,80	Koffer 70x50 KWZUKOF5070 € 421,20	Koffer 70x70 KWZUKOF7070 € 485,20

Datenspeicherung/Servicebox				
<p>Die Datenauswertung bietet Ihnen die Möglichkeit, mit Ihrem Speed Display Geschwindigkeiten nicht nur anzuzeigen, sondern die gemessenen Verkehrsdaten auch aufzuzeichnen und auszuwerten. Mit Hilfe unserer speziell entwickelten Software können Sie Ihre Daten auf einfachste Weise anschaulich aufbereiten und für Ihre Projekte, wie z. B. Verkehrsanalysen, Bürgerbegehren etc. nutzbar machen. Nach der Datenauswertung kann ein PDF-Dokument unmittelbar erzeugt und ausgedruckt werden. Dieses Dokument stellt sämtliche Daten über den jeweiligen Auswertzeitraum kompakt und übersichtlich dar.</p> 	Servicebox		Servicebox KVVAP_SERVICEBOX € 224,00	
			Datenspeicher für Servicebox KVVAP_STORE_SD € 350,80	
	WLAN/WIFI			Servicebox und Datenspeicher KVVAP_MMCEX € 574,80
				WIFI-Terminal KVVWIFI_TERMINAL Anfrage
			Interne Datenspeicher über WIFI-Modul KVVWIFI_MOD_STORE Anfrage	
			Speicherkarte für Speed Display KWVSDCARD Anfrage	

ABP-Reflektoren

ITEK-ABP-Reflektoren eignen sich hervorragend für

- dauerhafte, sichtbare, seitliche Markierungen jeglicher Barrierearten wie Betonleitwände, Leitschienen usw.
- massive Ausführung aus Alu 2,4mm Stärke
- klare rot-weiße Linienführung vermindert Fehlverhalten von KFZ-Lenkern
- dank der 180°-Reflektion ist der ABP-Reflektor von jedem Winkel aus sichtbar

Ausführung:

gekantetes Wellenblech, belegt mit Folie Type 3 rot/weiss, flexibel verlängerbar

Material:

- Aluminium mit 2,4mm Stärke
- 3M-Folie Type 3 DG, hochrückstrahlend, rot/weiss

Maße:

BxTxH: 230x26x200/100mm

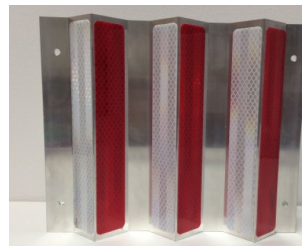

Ausführung	Höhe mm	Best.-Nr. Preis
rot/weiss	200	KZUABP200N € 13,10
	100	KZUABP100N € 8,40

ab 100 Stk: -10% Rabatt
ab 200 Stk: -20% Rabatt
ab 500 Stk: -40% Rabatt

Andere Farben und Höhen auf Anfrage!

Flexible Längen durch Kombination mehrerer Einzelteile!

Einsatzbeispiele



Leitschienenreflektoren

ohne Befestigungsmaterial

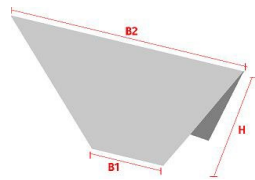

Type	Maße in mm B1/B2xH	Ausführung	Best.-Nr. Preis
VOEST 1	37/130x55	doppelseitig rot/weiss	KZU13B € 16,50
		einseitig rot oder weiss	KZU13E € 14,90
VOEST 2	32/105x55	doppelseitig rot/weiss	KZU14B € 16,50
		einseitig rot oder weiss	KZU14E € 14,90
VOEST 3	35/185x80	doppelseitig rot/weiss	KZU15B € 19,50
		einseitig rot oder weiss	KZU15E € 17,90

Reflektor BRL 150

bruchfester Kunststoff mit 3M Diamond Grade Folie Type 3 belegt
ohne Befestigungsmaterial



Ausführung	Maße in mm BxH	Ausführung	Best.-Nr. Preis
liegend	130x110	doppelseitig rot/weiss	KZU29LB € 12,40
		einseitig rot oder weiss	KZU29LE € 10,90

Leitschienenhalterung für BRL 150

in hochwertiger Nirosta-Ausführung
ohne Befestigungsmaterial



Best.-Nr. Preis
KZU31 € 8,40

Solar LED-Marker - Type EDGE POINTER

ohne Befestigungsmaterial

blinkend - Frequenz: 240x/min

Blinkfrequenz reduzierbar - Preis und Lieferzeit auf Anfrage!

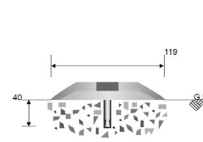
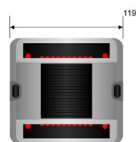
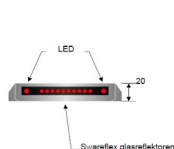
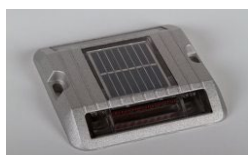

Maße in mm BxH	Ausführung	Best.-Nr. Preis
119x119x20	doppelseitig rot/weiss	KZUEPBS Anfrage
	einseitig rot	KZUEPESR Anfrage
	einseitig weiss	KZUEPESW Anfrage

Windsack

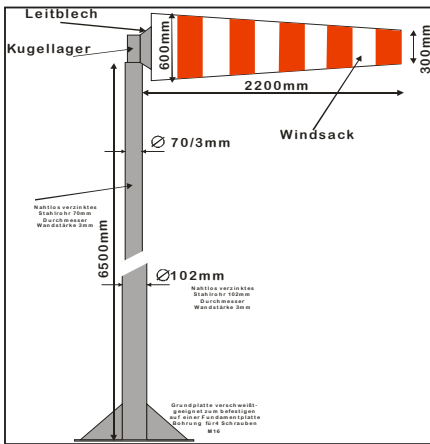

Artikel	Best.-Nr. Preis
Masten feuerverzinkt mit Standplatte, Leitblech und Windsack kugelgelagert, Höhe 6m, ohne Schrauben	KZU40 Anfrage
Windsack mit Aluring	KZU41 € 663,40

Schneeschutztafel

- Rahmen aus Aluminiumprofil
- stabile Klemmverbindung
- hoher Widerstandsmoment
- Schraubverbindung aus V4-Material



Maße	Ausführung	Best.-Nr. Preis
2500x1500 mm	ohne I-Steher, ohne Laschen	KZU50 € 1.852,30
2500x1500 mm	mit 2 I-Steher Länge: 3500mm mit 6 Profilsteher-Laschen KS00LB	KZU50ST € 2.701,90

RAL-Beschichtung (RAL 9006) gegen Aufpreis!

SOS-Infoschild



Maße	Ausführung	Best.-Nr. Preis
180x750 mm	flach Folie Type 1	KZU50SOS1 € 53,20
	flach Folie Type 2	KZU50SOS2 € 66,40



DIGITALDRUCK MACHT EINDRUCK.



ITEK



Absperrpfosten

Montagemöglichkeiten:



zum Aufdübeln:
Pfostenlänge: 1000 mm
(Lieferung ohne Befestigungsmaterial)



zum Einbetonieren:
Pfostenlänge: 1330 mm
davon 330 mm Unterflur

feststehende Absperrpfosten

Type Morion
feuerverzinkt, rot-weiss-rot
Maße: 70x70mm
ohne Befestigungsmaterial



Montage	Best.-Nr. Preis
zum Einbetonieren	KMORIONBB € 134,60
zum Aufdübeln	KMORIONBA € 215,60
Aufpreis für Öse (verzinkt)	KOESE € 19,60

umklappbare Absperrpfosten

Type Sesam - Kipp-Pfosten
feuerverzinkt, rot-weiss-rot
Maße: 70x70mm
ohne Befestigungsmaterial



Ausführung	Montage	Best.-Nr. Preis
 Dreikantschloss (Lieferung ohne Dreikantschlüssel)	zum Einbetonieren	KSESAMBB € 326,00
	zum Aufdübeln	KSESAMBA € 334,50
	Dreikantschlüssel	KDREIKANT € 20,30
 Zylinderschloss (Lieferung: inkl. 2 Schlüssel)	zum Einbetonieren	KSESAMAB € 297,70
	zum Aufdübeln	KSESAMAA € 288,40
	zusätzlicher Schlüssel	KZYLINDSCHL € 68,20

herausnehmbarer Absperrpfosten

Type Parat
feuerverzinkt, rot-weiss-rot
Maße: 70x70mm
ohne Befestigungsmaterial



Ausführung	Montage	Best.-Nr. Preis
 Dreikantschloss (Lieferung ohne Dreikantschlüssel)	zum Einbetonieren	KPARATB € 294,00
	zum Aufdübeln	KPARATA € 333,60
	Dreikantschlüssel	KDREIKANT € 20,30



Kettenabspernung - Steher verzinkt

Rundsteher verzinkt mit DM 60mm
mit rot-weiß-roter Folie belegt (gesamt 15cm)
Lieferung ohne Absperrkette



DM/Länge	Ausführung	Best.-Nr. Preis
60/1500mm	mit 1 Öse	KKE11V1 € 132,70
	mit 2 Ösen	KKE11V2 € 135,70

Zubehör für Kettenabspernungen

Artikel	Ausführung	Verpackungseinheit	Best.-Nr. Preis/lfm od. Stk.
Kette	Stahl verzinkt (keine Lackierung) SM-Stahl 6	1 Bd = 30 lfm	KKE04V € 6,70
	Kunststoff, rot-weiss-rot MNK-Güte 6	1 Bd = 50 lfm	KKE03V € 2,20
Scherenglied	Stahl verzinkt (keine Lackierung)	VPE=10 Stk.	KKE06V € 2,80
	Kunststoff, rot	VPE=10 Stk.	KKE05V € 1,80

Schrankensysteme

Manuelle Schrankensysteme

Klassische Systemschranke mit Gewichtsausgleich
durch integrierte Gasdruckfeder
Aluminium-Schrankenbaum DM 80mm, weiß lackiert mit roten, reflektierenden Folien
alle Stahlteile verzinkt und rot lackiert
mit Bodenplatten zum Aufdübeln
auf Wunsch auch zum Einbetonieren

Preis auf Anfrage!



Ausführungen:

mit festem Auflagepfosten zum Aufdübeln



mit schwenkbarem Auflagepfosten (Pendelstütze)

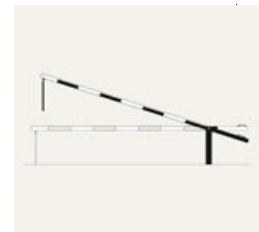

Schrankensystem mit Elektroantrieb

- Zutritt nur für autorisierte Personen
- optimale technische Ausführung durch Edelstahlgehäuse, das den elektrischen Antrieb sowie die hochwertige Steuerungstechnik umschließt
- Rund- oder Flachholme sperren die Straße

Preis auf Anfrage!



Fahnenmast

Fahnenkonfektionierungen

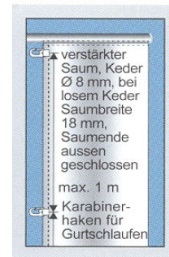
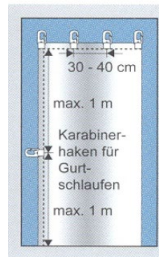

Fahnenmast mit Drehausleger - Seilhissung

Zylindrischer Fahnenmast
innenliegende Hissvorrichtung
hissbarer Drehausleger (Seilhissung)
vertikale Fahnenführung durch Gurtschlaufen am Mast
leichtes Einholen und Hissen der Fahne



Preis auf Anfrage!

Fahnenmast mit Drehausleger - Kurbelhissung

Zylindrischer Fahnenmast
Doppelkammerprofil
innenliegende Hissvorrichtung
hissbarer Drehausleger (Kurbelhissung)
vertikale Fahnenführung durch Gurtschlaufen am Mast
leichtes Einholen und Hissen der Fahne



Preis auf Anfrage!

Fahnen

passend für Fahnen mit Drehausleger



Österreich-Fahne



Landes-Fahne























Gemeinde-Fahne





















Individuelle Fahnen

Ausführung	Maße/mm	Best.-Nr. Preis
Österreich-Fahne	100x4000	KZU65-A € 209,20
Landes-Fahne	100x4000	KZU65-L € 261,50
Gemeinde-Fahne	100x4000	KZU65-G € 304,80
Individ. Fahne	100x4000	KZU65-I € 585,10





BAUSTELLENAUSRÜSTUNG		Temporäre Verkehrszeichen - zertifiziert nach RVS 08.31.02 (gültig ab Nov. 2016)					
GEFAHRENZEICHEN § 50	MASSE/ STÄRKE MM	AUSFÜHRUNG FLACH		Vorschriftszeichen § 52	MASSE/ STÄRKE MM	AUSFÜHRUNG FLACH	
		Folie EGP Type 1	Folie HIP Type 2			Folie EGP Type 1	Folie HIP Type 2
Querrinne oder Aufwölbung § 50/1 	700/1,5	K50103B € 48,60	K50102B € 59,20	Vorrang geben § 52/23 	700/1,5		K522302B € 59,20
	1000/1,5	K50106B € 110,60	K50105B € 141,30		1000/1,5		K522305B € 141,30
Fahrbahnverengung beidseitig § 50/8a 	700/1,5	K508A03B € 48,60	K508A02B € 59,20	Halt § 52/24 	630x630/1,5		K522402B € 98,80
	1000/1,5	K508A06B € 110,60	K508A05B € 141,30		940x940/1,5		K522405B € 205,90
Fahrbahnverengung linksseitig § 50/8b 	700/1,5	K508B03B € 48,60	K508B02B € 59,20	Fahrverbot in beiden Richtungen § 52/1 	670/1,5	K52106B € 61,60	K52105B € 79,00
	1000/1,5	K508B06B € 110,60	K508B05B € 141,30		960/1,5	K52109B € 124,30	K52108B € 160,90
Fahrbahnverengung rechtsseitig § 50/8c 	700/1,5	K508C03B € 48,60	K508C02B € 59,20	Einfahrt verboten § 52/2 	670/1,5		K52205B € 79,00
	1000/1,5	K508C06B € 110,60	K508C05B € 141,30		960/1,5		K52208B € 160,90
Baustelle § 50/9 	700/1,5	K50903B € 48,60	K50902B € 59,20	Einbiegen nach links verboten § 52/3a 	670/1,5	K523A06B € 61,60	K523A05B € 79,00
	1000/1,5	K50906B € 110,60	K50905B € 141,30		960/1,5	K523A09B € 124,30	K523A08B € 160,90
Schleudergefahr § 50/10 	700/1,5	K501003B € 48,60	K501002B € 59,20	Einbiegen nach rechts verboten § 52/3b 	670/1,5	K523B06B € 61,60	K523B05B € 79,00
	1000/1,5	K501006B € 110,60	K501005B € 141,30		960/1,5	K523B09B € 124,30	K523B08B € 160,90
Steinschlag § 50/10b 	700/1,5	K5010B03B € 48,60	K5010B02B € 59,20	Überholen verboten § 52/4a 	670/1,5		K524A05B € 79,00
	1000/1,5	K5010B06B € 110,60	K5010B05B € 141,30		960/1,5		K524A08B € 160,90
Achtung Gegenverkehr § 50/14 	700/1,5	K501403B € 48,60	K501402B € 59,20	Ende des Überholverbotes § 52/4b 	670/1,5	K524B06B € 61,60	K524B05B € 79,00
	1000/1,5	K501406B € 110,60	K501405B € 141,30		960/1,5	K524B09B € 124,30	K524B08B € 160,90
Vorankündigung e. Lichtzeichens § 50/15 	700/1,5	K501503B € 48,60	K501502B € 59,20	Wartepflicht bei Gegenverkehr § 52/5 	670/1,5	K52506B € 61,60	K52505B € 79,00
	1000/1,5	K501506B € 110,60	K501505B € 141,30		960/1,5	K52509B € 124,30	K52508B € 160,90
Andere Gefahren § 50/16 	700/1,5	K501603B € 48,60	K501602B € 59,20	Fahrverbot für Lastkraftfahrzeuge § 52/7a 	670/1,5	K527A06B € 61,60	K527A05B € 79,00
	1000/1,5	K501606B € 110,60	K501605B € 141,30		960/1,5	K527A09B € 124,30	K527A08B € 160,90



BAUSTELLENAUSRÜSTUNG		Temporäre Verkehrszeichen - zertifiziert nach RVS 08.31.02 (gültig ab Nov. 2016)					
Vorschriftszeichen § 52	MASSE/ STÄRKE MM	AUSFÜHRUNG FLACH		Vorschriftszeichen § 52	MASSE/ STÄRKE MM	AUSFÜHRUNG FLACH	
		Folie EGP Type 1	Folie HIP Type 2			Folie EGP Type 1	Folie HIP Type 2
Fahrverbot für Lastkraftfahrzeuge mit Gewichtsangabe § 52/7a 	670/1,5 960/1,5,5	K527A15B € 61,60 K527A18B € 124,30	K527A14B € 79,00 K527A17B € 160,90	Halten und Parken verboten mit Eindruck (ANFANG, ENDE, MITTE) § 52/13b 	670/1,5 960/1,5,5	K5213B15B € 61,60 K5213B18B € 124,30	K5213B14B € 79,00 K5213B17B € 160,90
Fahrverbot für Fahrzeuge mit über...m breite Fahrzeuge § 52/9a 	670/1,5 960/1,5,5	K529A06B € 61,60 K529A09B € 124,30	K529A05B € 79,00 K529A08B € 160,90	vorgeschriebene Fahrtrichtung § 52/15b 	670/1,5 960/1,5		K5215B05B € 79,00 K5215B08B € 160,90
Fahrverbot für Fahrzeuge mit über...m hohe Fahrzeuge § 52/9b 	670/1,5 960/1,5,5	K529B06B € 61,60 K529B09B € 124,30	K529B05B € 79,00 K529B08B € 160,90	vorgeschriebene Fahrtrichtung § 52/15c 	670/1,5 960/1,5		K5215C05B € 79,00 K5215C08B € 160,90
Fahrverbot für Fahrzeuge mit über...t Gesamtgewicht § 52/9c 	670/1,5 960/1,5,5	K529C06B € 61,60 K529C09B € 124,30	K529C05B € 79,00 K529C08B € 160,90	vorgeschriebene Fahrtrichtung § 52/15d - schräg rechts 	670/1,5 960/1,5		K5215D05B € 79,00 K5215D08B € 160,90
Fahrverbot für Fahrzeuge mit über...t Achsdruck § 52/9d 	670/1,5 960/1,5,5	K529D06B € 61,60 K529D09B € 124,30	K529D05B € 79,00 K529D08B € 160,90	vorgeschriebene Fahrtrichtung § 52/15d - gerade 	670/1,5 960/1,5		K5215D0G05B € 79,00 K5215D0G08B € 160,90
Geschwindigkeitsbeschränkung § 52/10a 	670/1,5 960/1,5,5	K5210A06B € 61,60 K5210A09B € 124,30	K5210A05B € 79,00 K5210A08B € 160,90	vorgeschriebene Fahrtrichtung § 52/15e 	670/1,5 960/1,5		K5215E05B € 79,00 K5215E08B € 160,90
Ende der Geschwindigkeitsbeschränkung § 52/10b 	670/1,5 960/1,5,5	K5210B06B € 61,60 K5210B09B € 124,30	K5210B05B € 79,00 K5210B08B € 160,90	vorgeschriebene Fahrtrichtung § 52/15f 	670/1,5 960/1,5		K5215F05B € 79,00 K5215F08B € 160,90
Ende von Überholverboten und Geschwindigkeitsbeschränkungen § 52/11 	670/1,5 960/1,5,5	K521106B € 61,60 K521109B € 124,30	K521105B € 79,00 K521108B € 160,90	vorgeschriebene Fahrtrichtung mit Eindruck "Fußgänger" 	480/1,5 670/1,5	K5215FG03B € 41,00 K5215FG06B € 61,60	K5215FG02B € 53,90 K5215FG05B € 79,00
Parken verboten § 52/13a 	670/1,5 960/1,5,5	K5213A06B € 61,60 K5213A09B € 124,30	K5213A05B € 79,00 K5213A08B € 160,90	Gehweg § 52/17 	670/1,5	K521706B € 61,60	K521705B € 79,00
Halten und Parken verboten § 52/13b 	670/1,5 960/1,5,5	K5213B06B € 61,60 K5213B09B € 124,30	K5213B05B € 79,00 K5213B08B € 160,90				

BAUSTELLENAUSRÜSTUNG		Temporäre Verkehrszeichen - zertifiziert nach RVS 08.31.02 (gültig ab Nov. 2016)					
HINWEISZEICHEN § 53	MASSE/ STÄRKE MM	AUSFÜHRUNG FLACH		ZUSATZTAFELN § 54	MASSE/ STÄRKE MM	AUSFÜHRUNG FLACH	
		Folie EGP Type 1	Folie HIP Type 2			Folie EGP Type 1	Folie HIP Type 2
Parken § 53/1a 	470x470/1,5	K531A03B € 57,40	K531A02B € 65,90	Anfang § 54 	310x150/1,5	K54010306B € 31,30	K54010305B € 33,10
	630x630/1,5	K531A06B € 88,10	K531A05B € 102,80		470x230/1,5	K54011506B € 40,00	K54011505B € 44,10
					630x230/1,5	K54012206B € 45,80	K54012205B € 51,30
Kennzeichnung eines Schutzwegs § 53/2a 	470x470/1,5		K532A02B € 65,90	Ende § 54 	310x150/1,5	K54010306EB € 31,30	K54010305EB € 33,10
	630x630/1,5		K532A05B € 102,80		470x230/1,5	K54011506EB € 40,00	K54011505EB € 44,10
					630x230/1,5	K54012206EB € 45,80	K54012205EB € 51,30
Ende des Gegenverkehrs § 53/7 	470x470/1,5	K53703B € 57,40	K53702B € 65,90	Text nach Kundenwunsch Grundtafel leer + € 5,00 pro Zeile + € 10,00 pro Symbol § 54	310x150/1,5	K540103B € 31,30	K540102B € 33,10
	630x630/1,5	K53706B € 88,10	K53705B € 102,80		310x310/1,5	K540106B € 38,60	K540105B € 42,20
					470x150/1,5	K540112B € 35,70	K540111B € 38,60
Wartepflicht für Gegenverkehr § 53/7a 	470x470/1,5	K537A03B € 57,40	K537A02B € 65,90		470x230/1,5	K540115B € 40,00	K540114B € 44,10
	630x630/1,5	K537A06B € 88,10	K537A05B € 102,80		470x310/1,5	K540118B € 45,80	K540117B € 51,30
					470x470/1,5	K540121B € 57,40	K540120B € 65,90
Einbahnstraße § 53/10 	960x310/1,5 rechts	K531003B € 67,60	K531002B € 78,60		630x230/1,5	K540124B € 45,80	K540123B € 51,30
	960x310/1,5 links	K531006B € 67,60	K531005B € 78,60		630x310/1,5	K540127B € 53,10	K540126B € 60,40
					630x470/1,5	K540130B € 67,60	K540129B € 78,60
Sackgasse § 53/11 	470x470/1,5	K531103B € 57,40	K531102B € 65,90		630x630/1,5	K540133B € 88,10	K540132B € 102,80
	630x630/1,5	K531106B € 88,10	K531105B € 102,80		960x310/1,5	K540136B € 67,60	K540135B € 78,60
					960x470/1,5	K540139B € 96,80	K540138B € 113,70
Vorankündigung einer Umleitung § 53/16a 	1300x2000/1,5	K5316A03B € 628,80	K5316A02B € 747,40		960x630/1,5	K540142B € 118,50	K540141B € 141,00
					960x960/1,5	K540145B € 174,90	K540144B € 209,10
Umleitung § 53/16b 	1150x250/1,5	K5316B10503B € 82,00	K5316B10502B € 95,20				
	1150x400/1,5	K5316B10513B € 112,50	K5316B10512B € 133,50				
	1150x310/1,5 alte Ausführung	K5316B03B € 94,50	K5316B02B € 111,00				
Umleitung § 53/16b 	1150x250/1,5	K5316B10523B € 82,00	K5316B10522B € 95,20				
3-zeilige Umleitungstafel mit einschiebbaren Einzelbuchstaben 	1500x1000/1,5	K5399B03B € 636,10	K5399B02B € 724,40				
	Ziffer/Buchstabe	K5399B06B € 32,10	K5399B05B € 34,70				



BAUSTELLENAUSRÜSTUNG		Temporäre Verkehrszeichen - zertifiziert nach RVS 08.31.02 (gültig ab Nov. 2016)					
SONDERTAFELN NACH RVS	MASSE/ STÄRKE MM	AUSFÜHRUNG FLACH		SONDERTAFELN NACH RVS	MASSE/ STÄRKE MM	AUSFÜHRUNG FLACH	
		Folie EGP Type 1	Folie HIP Type 2			Folie EGP Type 1	Folie HIP Type 2
rechteckige Leitplanke 	2000x470/1,5	KRVS106B € 51,30	KRVS105B € 171,00	Leitwinkel 	470x700/1,5 600x900/1,5	KRVS141B € 90,10	KRVS144B € 132,20
Absperrlatte 	1000x150/1,5	KRVS99B € 45,80	KRVS98B € 51,30	Leitbake 	250x1000/1,5 links 250x1000/1,5 rechts	KRVS112B € 60,30	KRVS111B € 69,50
Preis pro lfm.							

Bautafeln/Firmentafeln

Ausführungen:

Kunststoff-Tafel: 2 oder 3mm Wandstärke, mit Klebetext oder im Digitaldruck belegt

Aluminiumtafel: 2 oder 3mm Wandstärke, flach oder mit Alformprofil, mit Klebetext oder im Digitaldruck belegt

Anti-Graffiti-Schutz: Bei allen Ausführungen gibt es die Möglichkeit einer Anti-Graffiti-Beschichtung (Aufpreis)!

Montage: Auf Wunsch führen wir selbstverständlich auch die Montage durch!



Preis auf Anfrage



Verkehrszeichenmagazin für Baustellenabsicherungen - Schnellbausystem

inkl. Transportpalette
inkl. VZ für Baustellenabsicherungen gem. RVS

OHNE BAKENFÜSSE



auswählen



montieren



fertig

Artikel	Ausführung	Best.-Nr. Preis
Type L	VZ-Materialstärke 1,5mm	KEE0300BVZ € 1.638,80
	Materialstärke 2,5mm	KEE0300STDVZ € 1.910,40
Type B	VZ-Materialstärke 1,5mm	KEE0301BVZ € 2.563,50
	Materialstärke 2,5mm	KEE0301STDVZ € 3.285,60
Transportgestell Type L	Gr. 800x1000 für bis zu 19 VZ	KEE0300 € 549,00
Transportgestell Type B	Gr. 800x1500 für bis zu 29 VZ	KEE0301 € 656,10
Transportgestell Sonderauf.	Gr. 800x2000 für bis zu 36 VZ	KEE0302 € 787,20

VZ-Magazin Type "L" für Landes- und Gemeindestraßen:

- 2x 50/16 Achtung Baustelle, Gr. 700, Folie Type 1
- 2x 50/8a Fahrbahnverengung beidseitig, Gr. 700, Folie Type 1
- 2x 52/10a Geschwindigkeitsbeschränkung "70", Gr. 670, Folie Type 1
- 2x 52/10a Geschwindigkeitsbeschränkung "50", Gr. 670, Folie Type 1
- 2x 52/10a Geschwindigkeitsbeschränkung "30", Gr. 670, Folie Type 1
- 4x 52/4a Überholen verboten, Gr. 670, Folie Type 2
- 2x 52/11 Ende von Überholverboten und Geschwindigkeitsbeschränkungen, Gr. 670, Folie Type 1
- 1x 52/5 Wartepflicht bei Gegenverkehr, Gr. 670, Folie Type 1
- 1x 52/15d vorgeschriebene Fahrtrichtung schräg rechts, Gr. 670, Folie Type 2
- 1x 53/7a Wartepflicht für Gegenverkehr, Gr. 470x470, Folie Type 1
- 19x Vierkantrhrsteher/Unterteil
- 1x Transportgestell

VZ-Magazin Type "B" für Bundesstraßen und Autobahnen:

- 2x 50/16 Achtung Baustelle, Gr. 1000, Folie Type 1
- 2x 50/8a Fahrbahnverengung beidseitig, Gr. 1000, Folie Type 1
- 2x 52/10a Geschwindigkeitsbeschränkung "70", Gr. 960, Folie Type 1
- 2x 52/10a Geschwindigkeitsbeschränkung "50", Gr. 960, Folie Type 1
- 2x 52/10a Geschwindigkeitsbeschränkung "30", Gr. 960, Folie Type 1
- 4x 52/4a Überholen verboten, Gr. 960, Folie Type 2
- 2x 52/11 Ende von Überholverboten und Geschwindigkeitsbeschränkungen, Gr. 960, Folie Type 1
- 1x 52/5 Wartepflicht bei Gegenverkehr, Gr. 960, Folie Type 1
- 1x 52/15d vorgeschriebene Fahrtrichtung schräg rechts, Gr. 960, Folie Type 2
- 1x 53/7a Wartepflicht für Gegenverkehr, Gr. 630x630, Folie Type 1
- 19x Vierkantrhrsteher/Unterteil
- 1x Transportgestell

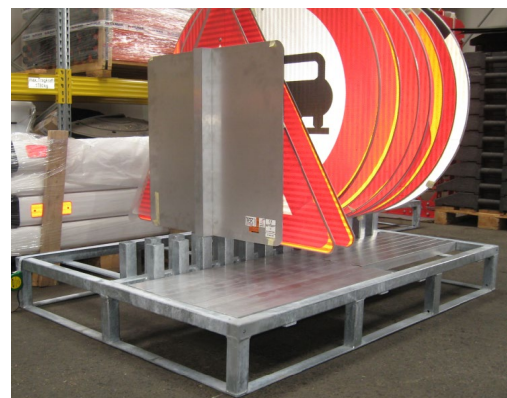

Steher und Zubehör

Vierkantsteher

Formrohrsteher Alu 40x40x2,5mm
inkl. Abdeckkappe



Länge	Best.-Nr. Preis
1500	KRS23AF € 40,20
2000	KRS33AF € 48,90
2500	KRS43AF € 65,70
3000	KRS53AF € 76,10

Kunststoffrohr

Klemmfix Kunststoffrohr DM=42mm
inkl. Rohrschuh 60/60

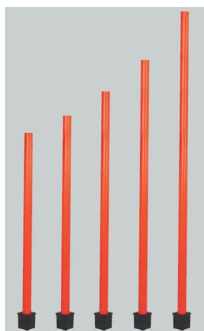

Länge	Best.-Nr. Preis
2000	KKF47 € 47,80
Rohrschuh	KKF51 € 4,60

VE=10 Stk.

Klemmfix Schilderhalter

128 MS
für Rohre DM 42 und 40x40



Maße	Best.-Nr. Preis
85x80x60	KKF48 € 7,20

Ständerkreuz

verzinkte Ausführung
für Rohre DM 60mm und 48mm



Ausführung	Rohr-DM	Maße	Best.-Nr. Preis
Type A	48	500x500	KBS73 € 153,60
Type B	60	1000x1000	KBS74 € 192,00



TL-Schilderständer

verzinkte Ausführung



Type "City"
40x40mm Schaftrrohr, geeignet zur Aufnahme von bis zu 4 Bakenfüße



Type "Profi"
60x60mm Schaftrrohr, geeignet zur Aufnahme von bis zu 10 Bakenfüße

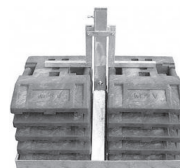

Ausführung	Rohr-DM	Best.-Nr. Preis
Type City	40x40	KBSEE0172 Anfrage
Type Profi	60x60	KBSEE0190 € 590,80

Universalbakenfüße

geeignet für Rohrsteher mit DM 60mm, DM 48mm und Formrohre mit DM 40x40mm
aus 100% Kunststoffrecycling-Material

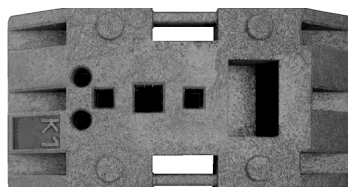

Maße	Gewicht	Best.-Nr. Preis
800x400x120	28kg	KBS79 € 30,20

Beschwerungssäcke

mit Tragegriff
orange



Maße	Gewicht	Best.-Nr. Preis
600x400x80	0,5 kg unbefüllt	KBS200 € 28,00
	15 kg befüllt	KBS201 Anfrage

Anhaltevorrichtungen und Absperrmaterial

Winkerkelle

Winkerkelle - Holz

Ausführung Aluminium mit 3M-Folie Type 1 beidseitig belegt (rot/grün)
mit Holzstiel (Länge: 400mm)
Durchmesser: 205mm



Best.-Nr. Preis
KBS102 € 105,20

Winkerkelle - Kunststoff

Ausführung: Kunststoff mit Beleuchtung
mit rückstrahlendem Rand
ohne Batterien



Ausführung	Best.-Nr. Preis
Standard	KBS103 Anfrage
LED	KBS103LED Anfrage

BAUSTELLENAUSRÜSTUNG

Baustellen- und Sicherheitsprodukte

Anhaltstab

Signalstab für Verkehrsposten
Ausführung Aluminium mit 3M-Folie Type 1 beidseitig belegt (rot/grün)
mit Holzstiel (Länge: 1600mm)
Durchmesser: 480mm



Best.-Nr. Preis
KBS104 € 157,10

Absperrungen

Mobile Absturzsicherung

hochwertiger, schlagzäher, UV-beständiger Kunststoff, wartungsfrei
belegt mit reflektierender Folie Type 1
umlaufender, stabiler Folienschutzrand
austauschbare Stützen für Warnleuchten
leichte Handhabung durch geringes Gewicht
Lieferung ohne Bakenfüße

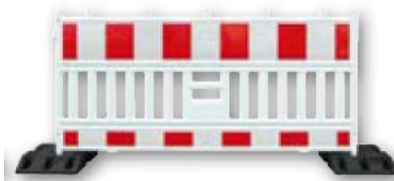

Individuelle Beschriftungen auf Anfrage (Beschriftungsfeld: 230x100mm)

Ausführung	Gewicht	Best.-Nr. Preis
2000x1100	15,5 kg	KVA2000 € 139,00

Preis pro Stück
Mindestabnahme: 10 Stück

Weitere Längen und Zubehör auf Anfrage!

Mobile Kunststoffleitwand

Material: lineares Polyethylen (LLD_PED) stabil,
hält auch stärksten Belastungen stand
einfachste Montage durch das praktische Klemmverschlusssystem
sichert Gefahrenstellen
befüllbar mit z.B. Wasser, Sand usw.
Größe: Länge 1070mm, Breite 400mm, Höhe 490mm
Gewicht: leer 7kg



Ausführung	Best.-Nr. Preis
rot	KBSMLR01 € 139,00
weiß	KBSMLW01 € 139,00

Absperrschere rot/weiss/rot

ausziehbar
aus Holz



Standard



Stabil

Ausführung	Länge	Best.-Nr. Preis
Standard	3000	KBS1043 € 114,50
	5000	KBS1045 € 133,30
Stabil	5000	KBS1045ST Anfrage

ausziehbar
aus Alu

Robuste, stabile Absperrgitter aus Alu-Formrohren



- robustes Absperrgitter
- aus 40x20-Alu-Formrohren
- Höhe 1m
- Ausziehbar
- rot-weiß-rot beschichtet
- mit Reflexstreifen
- in 2 Längen erhältlich

Ausführung	Länge	Best.-Nr. Preis
Standard	3000	KBS1043ALU € 371,30
	5000	KBS1045ALU € 592,50

Absperrbock

aus Holz



Höhe	Best.-Nr. Preis
0,8m	KBS112 € 34,70
1,4m	KBS113 € 56,90

Absperrständer

aus Holz



Höhe	Best.-Nr. Preis
1,5m	KBS112ST € 44,30

Absperrgitter

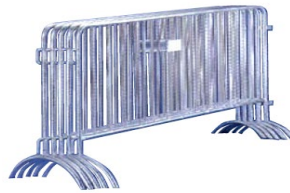

Größe	Best.-Nr. Preis
2000x1000	KBS110 € 199,60
2400x1000	KBS111 € 227,90

Absperrlatte und Absperrständer



Artikel	Länge	Best.-Nr. Preis
Absperrlatte aus Holz	4000	KBS106 Anfrage
Absperrstange	80x80x1500	KBS107 Anfrage

Absperrständer aus Rundstahl

Stahl mit DM 12mm

Höhe: 1300mm

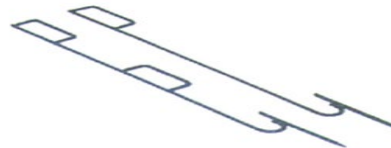

Artikel	Best.-Nr. Preis
1 Latte	KBS108 Anfrage
2 Latten	KBS109 Anfrage

Folienabsperband

rot-weiss-rot



im Karton
mit Abrollrichtung



fadenverstärkt
auf Kunststoffspule

Ausführung	Maße	Best.-Nr. Preis
im Karton	500mm lang, 80mm breit	KBS100 € 24,20
fadenverstärkt	250mm lang, 80mm breit	KBS100V € 49,00



Abdeckungen für Verkehrszeichen

Abdeckkappen für Verkehrszeichen



Ausführung	Best.-Nr. Preis
VZ 480	KKAI0267 € 36,40
VZ 670	KKAI0268 € 39,20
VZ 960	KKAI0269 € 47,60
VZ 700	KKAI0258 € 36,00
VZ 1000	KKAI0259 € 47,60

Abdeckbänder für Verkehrszeichen

zur Deaktivierung von Verkehrszeichen
bis 3 Wochen rückstandsfrei zu entfernen
Achtung "Probeklebung" vornehmen!!



50 mm

75 mm

100mm

Breite	Länge	Best.-Nr. Preis
50mm	33 lfm	KKF40 € 35,00
75mm	33 lfm	KKF41 € 51,60
100mm	33 lfm	KKF42 € 70,20

Warneinrichtungen

TRIOPAN - Fireball

MINI-LED-Blitzleuchte für temporäre Signalisation
Betriebszeit von 45 Std.
schnelle Montage - einfaches Aufstecken am Faltsignal
mit Leitkegeladapter auch für Leitkegel einsetzbar!
Lieferung: ohne Batterien



Fireball für Faltsignal



Leitkegeladapter für Fireball



Artikel	Best.-Nr. Preis
Fireball	KFIREBALL € 150,50
Leitkegeladapter	KFIREBALLHALT € 40,80

Warnsignal von Triopan

Warnsignal bei überhängenden Lasten (mit Spanngurt und Etui)
Klettstreifen um Fixation des Warnsignals zu erhöhen
Erhöhte Sichtbarkeit durch Silberreflex-Ecken



Best.-Nr. Preis
KTRIOWARNSIGNAL € 57,50

Doppelblitzmagnetleuchte

Höhe: 175mm
DM=160mm
mit Magnethalterung, Spiralkabel und Stecker für Zigarettenanzünder
verwendbar bis 250 km/h
Andere Farben auf Anfrage!



Ausführung	Best.-Nr. Preis
gelb	KBS150G € 560,00

Faltsignale und Zubehör

TRIOPAN - Faltsignal BASIC

aus hochwertigem beschichtetem Kunststoffgewebe PVC
 mit Futteral aus ölfestem Plastik
 sehr stabile Ausführung
 keine Ersatzteile
 keine individuelle Beschriftung möglich



Ausführung	Seitenlänge	Symbole	Best.-Nr. Preis
reflektierend	900	3x	KBS95TB € 262,70
		3x	KBS97TB € 262,70
	700	3x	KBS94TB € 176,90
		3x	KBS96TB € 176,90
nicht reflektierend	900	3x	KBS91TB € 138,10
		3x	KBS93TB € 138,10
	700	3x	KBS90TB € 105,40
		3x	KBS92TB € 105,40

KEINE ERSATZTEIL-MÖGLICHKEIT!

TRIOPAN - Faltsignal DELUXE

aus hochwertigem beschichtetem Kunststoffgewebe PVC
 mit Futteral aus ölfestem Plastik
 sehr stabile Ausführung



Ausführung	Seitenlänge	Symbole	Best.-Nr. Preis
reflektierend	900	3x gleiche Symbole	KBS95T € 610,60
		3x verschiedene Symbole	KBS97T € 563,50
	700	3x gleiche Symbole	KBS94T € 331,40
		3x verschiedene Symbole	KBS96T € 463,10
nicht reflektierend	900	3x gleiche Symbole	KBS91T € 294,70
		3x verschiedene Symbole	KBS93T € 394,90
	700	3x gleiche Symbole	KBS90T € 263,90
		3x verschiedene Symbole	KBS92T € 374,50

Ersatzteile auf Anfrage!



Leitkegel

Ausführung BASIC

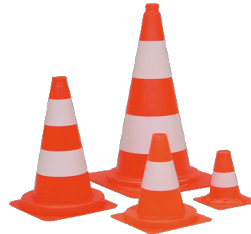

Ausführung	Höhe	Gewicht	Best.-Nr. Preis
tagesleuchtend 1 weißer Streifen	300	0,5	KBS80 € 14,00
tagesleuchtend 2 weißer Streifen	500	1,3	KBS81 € 20,20
tagesleuchtend, 3 weißer Streifen	750	4,3	KBS82 € 55,00

Ausführung MOLAN



Ausführung	Höhe	Gewicht	Best.-Nr. Preis
1 reflektierender Streifen	300	0,85	KBS80ML € 23,20
2 reflektierende Streifen	500	1,54	KBS81ML € 40,90
2 reflektierende Streifen	750	4,13	KBS82ML € 65,60

Leitkelleuchterset

komplett mit Leitkegel und Batteriekasten
Molan-Leitkegel mit 2 reflektierenden Streifen, Höhe 750mm
hohe Standfestigkeit
fertig zusammengebaut
Blitzleuchte: DM 200mm
Lieferung: ohne Batterien



Ausführung	Höhe	Best.-Nr. Preis
Blitzleuchte gelb - einseitig Leitkegel reflektierend	750	KBS141B € 415,40
Blitzleuchte gelb - doppelseitig Leitkegel reflektierend	750	KBS141BB € 449,40



Wendebake

Ausführung BASIC

Stützen: 60/60

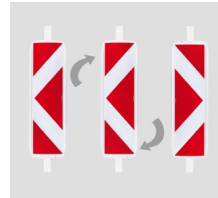

Ausführung	Folie Type	Best.-Nr. Preis	
einseitig	1	KBS60601	Anfrage
	2	kbs60602	Anfrage
	2 neon	KBS60602N	Anfrage
beidseitig	1	KBS60601B	Anfrage
	2	kbs60602B	Anfrage
	2 neon	KBS60602NB	Anfrage

Ausführung Klemmfix Horizont

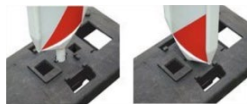

System SD

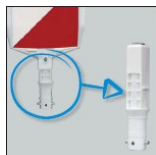

System D

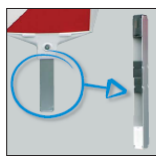

System M

Ausführung	Folie Type	Best.-Nr. Preis		
		System SD	System D	System M
einseitig	1	KBS117SD Anfrage	KBS117D Anfrage	KBS117M Anfrage
	2	KBS118SD Anfrage	KBS118D Anfrage	KBS118M Anfrage
	2 neon	KBS119SD Anfrage	KBS119D Anfrage	KBS119M Anfrage
beidseitig	1	KBS117SDB Anfrage	KBS117DB Anfrage	KBS117MB Anfrage
	2	KBS118SDB Anfrage	KBS118DB Anfrage	KBS118MB Anfrage
	2 neon	KBS119SDB Anfrage	KBS119DB Anfrage	KBS119MB Anfrage

Folien-Ausführung Klemmfix Horizont

Variante 1:
vorne rechtsweisend
hinten rechtsweisend

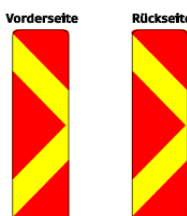

Variante 2:
vorne rechtsweisend
hinten linksweisend



Variante 3:
vorne linksweisend
hinten linksweisend



Baustellenleuchten und Baustellenampeln

Ausführung BASIC

LED-Ausführung
 blinkend oder Dauerlicht
 Stift zum Schalten der Funktion EIN/AUS bzw. BLINKEND oder DAUERLICHT
 Imbusschlüssel zum Öffnen des Gehäuses
 Diebstahlsicherung (Befestigungsbügel)
 Schnellmontagevorrichtung
 Lebensdauer der LED: ca. 100.000 Stunden
 Blinkfrequenz pro Minute: ca. 60 Mal
 erforderliche Batterie: 1x Energieblock /Zink/Kohle) 4R25, 6V/7000 mAh
 Lieferung: ohne Batterie



Ausführung	Best.-Nr. Preis
gelb/gelb	KBS130 € 23,80
rot/transp.	KBS131 € 30,00

Ausführung TRIOPAN Helios Master

LED-Ausführung
 Einfach-, Doppel- oder Trippelblitz
 Hintergrundbeleuchtung
 Laufzeit: ca. 250 Stunden
 Batterie: Trockenbatterie Typ 800
 passend für Faltsignale
 Linsen-DM: 200mm



Ausführung	Best.-Nr. Preis
gelb/gelb	KTRIOHELIOSV3 € 197,00
rot/weiß	KTRIOHELIOSV3R Anfrage

Batterien



Batterie 6V



Kompakt 50

Ausführung	Best.-Nr. Preis
Batterie 6V	KBS133 € 7,50
Luft-Sauerstoffbatterie Kompakt 50 6V 50Ah	KBS134 € 27,80

Baustellenampeln

MBP 1400 - quartzgesteuerte Signalanlage

für Einbahnwechsel, Einmündungs- und Kreuzungsverkehr
 Set bestehend aus 2 Signalgebern mit integrierter Quartzsteuerung in kompakter Bauweise
 Mit Aufsatzrohr und Akku-Untergestell zur Aufnahme von einem Akku 12V/170Ah.
 Einstellung der Parameter und Synchronisation kann bequem mittels Handbox erfolgen (nicht im Lieferumfang)



Handbox



Ausführung	Best.-Nr. Preis
MPB1400 LED (2 Stück)	KN1400L Anfrage
Handbox für MPB1400	KPB1450 Anfrage

Weitere Signalanlagen wie z.B. Funk-, Quarz- oder Kabelausführungen auf Anfrage!

LED-Lichtleitsystem

MobiLED Mini ESF/DSF

MobiLED Mini ESF/DSF



Beispiele



-  **Ausführung**
Fixmontage ohne Hubmotor
-  **LED-Anzeige**
Einseitig/Doppelseitig
-  **Tag/Nacht**
Automatische Nachtabsenkung
-  **Bedienung**
Funkbedienteil mit LCD-Display
-  **Extras**
Anschlussmöglichkeit für
2 Stk. Doppelblitzleuchten

Preis auf Anfrage

Anzeigemöglichkeiten

- 4-fach Aufbaupfeil links/rechts (LED's gelb)
- Doppelpfeil links/rechts (LED's gelb)
- Symbol "Andere Gefahr" (LED's rot/weiß)
- 2 Stk. LED-Flasher L2H (LED's gelb)

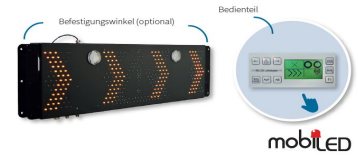

mobiled

MobiLED Mini ESH

MobiLED Mini ESH



Beispiele



-  **Ausführung**
Dachmontage mit Hubmotor
-  **LED-Anzeige**
Einseitig
-  **Tag/Nacht**
Automatische Nachtabsenkung
-  **Bedienung**
Funkbedienteil mit LCD-Display
-  **Extras**
Anschlussmöglichkeit für
2 Stk. Doppelblitzleuchten

Preis auf Anfrage

Anzeigemöglichkeiten

- 4-fach Aufbaupfeil links/rechts (LED's gelb)
- Doppelpfeil links/rechts (LED's gelb)
- Symbol "Andere Gefahr" (LED's rot/weiß)
- 2 Stk. LED-Flasher L2H (LED's gelb)



mobiled

MobiLED Standard ESH/DSH

MobiLED Standard ESH/DSH



Beispiele



-  **Ausführung**
Dachmontage mit Hubmotor
-  **LED-Anzeige**
Einseitig/Doppelseitig
-  **Tag/Nacht**
Automatische Nachtabsenkung
-  **Bedienung**
Funkbedienteil mit LCD-Display
-  **Extras**
Anschlussmöglichkeit für
2 Stk. Doppelblitzleuchten

Preis auf Anfrage

Anzeigemöglichkeiten

- 3-fach Aufbaupfeil links/rechts (LED's gelb)
- Doppelpfeil links/rechts (LED's gelb)
- Verkehrszeichen „Andere Gefahr“ (LED's rot/weiß)
- Verkehrszeichen „Stau“ (LED's rot/weiß)
- Schriftzug „Unfall“ (LED's rot)
- 2 Stk. LED-Flasher (LED's gelb)



mobiled



LED-Spotanlage

Basic 102

- LED-Projektor für feste oder temporäre Anwendungen (kleine Systeme)
- Einfach-, Zweifach-, Dreifach- oder Vierfach
- Größe: DM 139x19mm



Ausführung	Best.-Nr. Preis
Spot (1-fach)	KLEDBASIC102 € 134,00
Control-Unit-Box für Blitzfunktion	KLEDCONTROL € 154,00

Einsatzbereiche:



Basic 200 / 201

- LED-Projektor für feste oder temporäre Anwendungen
- Einfach-, Zweifach-, Dreifach- oder Vierfach-Blitz



Ausführung	Größe	Best.-Nr. Preis
Basic 200 2-fach Set	198x65	KLEDBASIC200 € 495,00
Basic 201 2-fach Set	198x25	KLEDBASIC201 € 495,00
Control-Unit-Box für Blitzfunktion		KLEDCONTROL € 154,00

Einsatzbereiche:

Basic 200:



Basic 201:

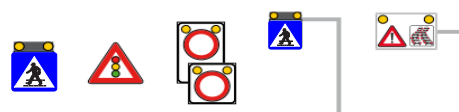

Photovoltaik-Kompaktanlage

Komplettes Photovoltaik-Set bestehend aus:

- Batterie, Laderegler, Photovoltaik-Modul, Gehäuse, Montageplatte
- von 10W 12 Ah bis 140W 90 Ah lieferbar

Best.-Nr. Preis
KLEDPHOTOV Anfrage



Laufflichtanlagen

TOP LED SYNCHRO

- kabellose 5-fach Anlage bestehend aus 5 Leuchten, 1 Fernbedienung, 1 Inbusschlüssel, 1 Stiftschlüssel
- Lieferung ohne Batterien



Ausführung	Best.-Nr. Preis
5-fach Anlage	KBS21132 € 956,70
Einzelleuchte	KBS21131 € 208,70
Kompakt 50 Batterie	KBS134 € 27,80

TRIOPAN HELIOS MASTER RF

- synchronisiert bis zu 10 Leuchten
- Lieferung ohne Batterien
- Einfach-, Doppel- oder Trippelblitz
- Aufbaulicht, Laufflicht, Blitzgewitter
- Funkreichweite von 100 Meter
- im Set mit Transportschale für 4 Blitzleuchten



Ausführung	Best.-Nr. Preis
Einzelleuchte	KTRIOHELIOSRF4 Anfrage

HORIZONT RS 2000

- Zwei RS 2000 Strahler sind fest miteinander verkabelt (3,5m) und können direkt angeschlossen werden
- zeitverzögertes Blitzen
- Umschaltung Synchron/Asynchron-Betrieb
- mit Dämmerungsautomatik
- bis zu 10 Strahlern zusammenschaltbar
- 5m Akkukabel



Ausführung	Best.-Nr. Preis
2-fach Anlage mit LED	KBS183H Anfrage
Zusatz-Richtstrahler	KBS183HE Anfrage
Akku 12V/180 Ah	KBS183HAKKU Anfrage
Großraum-Akkukasten	KBS183HAKKUKA Anfrage

Klemmfix-Sicherheitsprodukte

Klemmfix Leitschwelle

- aus Recyclingmaterial
- hervorragende Trennwirkung
- Anti-Rutsch-System
- inkl. Einsteckvorrichtung für Leitboy Oberteil und D-Baken-System



Mittelstück



Endstück A



Endstück B



Leuchtbügel

Ausführung	Best.-Nr. Preis
Mittelstück VPE= 50 Stk.	KKF01 Anfrage
Endstück A	KKF02 Anfrage
Endstück B	KKF03 Anfrage
Leuchtbügel	KKF04 Anfrage

Klemmfix Sichtzeichen L30

- reflektierende und flexible Sichtzeichen zur optischen Verkehrsführung
- besonders geeignet zur Fahrbahntrennung bzw. Baustellenverkehrsführung
- Maße: 174x280x24mm, Folie Type 2 (40x40mm)
- Fußplatte mit Reflektoren zum Ankleben oder Anschrauben
- Befestigungsmaterial nicht inkludiert



Anmerkung	Best.-Nr. Preis
VPE= 30 Stk.	KZUL30 Anfrage

Klemmfix Leitboy Mini Bake

- reflektierende und flexible Sichtzeichen zur optischen Verkehrsführung
- besonders geeignet zur Fahrbahntrennung bzw. Baustellenverkehrsführung
- diverse Größen und Ausführungen
- belegt mit Folie Type 2
- Befestigungsmaterial nicht inkludiert

Preis auf Anfrage



L 42
Gr. 570x180mm



L 72
Gr. 760x215mm



L 82
Gr. 730x155mm



L 92
Gr. 990x235mm

Klemmfix Klappbake KSN 407

- Klappbake mit Fußplatte

- Maße Bake: 970x215mm
- Maße Folie: 750x187,5mm
- Gewicht ca. 12 kg
- inkl. Tragegriff
- verschiedene Ausführungen - gewünschte Variante angeben!

Klappbox für 5 Klappbaken



Klappbox für 20 Klappbaken



Ausführung	Folie	Best.-Nr. Preis
einseitig	Folie Type 2	KKF352E Anfrage
beidseitig	Folie Type 2	KKF352B Anfrage
Klappbox für 5 Klappbaken 660x320x330mm (8,5 kg)		KKF38B Anfrage
Klappbox für 20 Klappbaken 1200x980x460mm (60kg)		KKF38 Anfrage

Warnleitanhänger, fahrbare Vorwarnschilder, Warnschwellen



Preis auf Anfrage

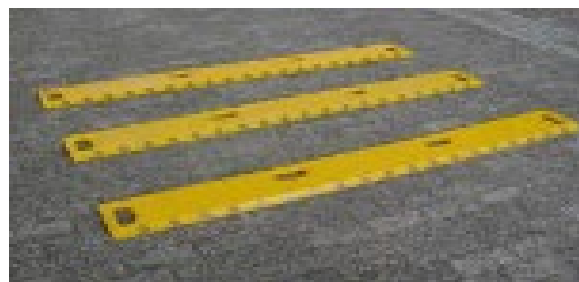

FOLIEN

Markierungsfolien

Industriewarnmarkierung

- 50 mm x 25 lfm
- je 1x links bzw. rechtsweisend



Ausführung	Best.-Nr. Preis
rot/weiss	KFOIWMRW-50 € 260,40
gelb/schwarz	KFOIWMGS-50 € 260,40

Fahrzeugmarkierung lt. RVS 5.41

- 282 mm x 4,5 m
- je 1x links- bzw. rechtsweisend



Ausführung	Best.-Nr. Preis
rot/weiss	KF051 € 554,20

Fahrzeugkonturmarkierung

- 55 mm x 50 lfm



Ausführung	Best.-Nr. Preis
weiss	KF071 € 201,20
rot	KF073 € 201,20
gelb	KF072 € 201,20

Planenfahrzeugkonturmarkierung

- 51 mm x 50 lfm



Ausführung	Best.-Nr. Preis
weiss	KF074 Anfrage
rot	KF075 Anfrage
gelb	KF076 Anfrage

Bodenmarkierung STAMARK

- orange
- 150 mm x 100 lfm



Best.-Nr. Preis
KF0STAMTMR-150ROLLE € 776,40

Blindenmarkierung

- 1 VPE = 5 Rollen
- 1 Rolle: 30 mm x 24 lfm
- entspricht ÖNorm V2102-1

Ausführung	Best.-Nr. Preis/VPE
schwarz	K3M385SCHW € 581,50
weiss	K3M385WEISS € 635,50

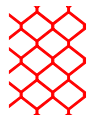
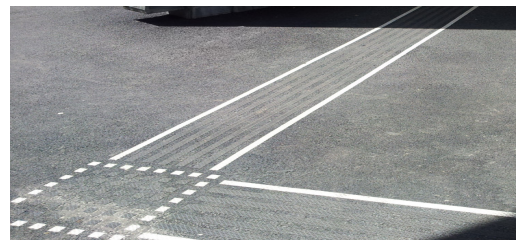

WIR SETZEN ZEICHEN.

ITEK

WARN-, HINWEIS- UND UNFALLVERHÜTUNGSSCHILDER

WHU-SCHILDER

Warn-, Hinweis- und Unfallverhütungsschilder lt. ÖNORM EN ISO 7010

Maximale Erkennungsweiten

Rettungs-, Brandschutz-,
Hinweis- und Zusatzzeichen



Seitenlänge BxH in mm	Max. Erkennungsweite in m
100 x 100	10
200 x 100	10
148 x 148	15
297 x 148	15
200 x 200	20
400 x 200	20

Warnzeichen



Seitenlänge in mm	Max. Erkennungsweite in m
100	3
200	7
400	13

Verbots- und Gebotszeichen



Seitenlänge BxH in mm	Max. Erkennungsweite in m
100	4
200	8
315	13
400	16

Ausführungsvarianten

Selbstklebeschilder:

nur Folie

Schutzpapier abziehen und auf glatter, staub- und fettfreier Fläche aufkleben

F = aus hochwertiger Folie

Kunststoffschilder

aus Kunststoff 1mm, mit Folie belegt

mit Bohrungslöcher zum Anschrauben

K = Kunststoff mit hochwertiger Folie belegt

Aluminiumschilder

aus Aluminium 1,5mm, mit Folie belegt

mit Bohrungslöcher zum Anschrauben

A = Aluminium mit hochwertiger Folie belegt

Weitere Ausführungen wie Winkel- oder Fahnschilder auf Anfrage!

Rettungs-, Brandschutz-, Hinweis- und Zusatzzeichen

Preise für WHU-Schilder in Standardausführung bzw. ohne Beschriftung	MASSE mm	Folie	Kunststoff	Aluminium	Aufpreis f. nachleuchtende Folie
		KWHUE01F	KWHUE01K	KWHUE01A	
Individuelle Beschriftungen: Aufpreis pro Zeile € 10,00 Aufpreis für Standardsymbol € 15,00	100x100	€ 10,60	€ 24,80	€ 25,10	Anfrage
	200x100	€ 11,20	€ 25,60	€ 26,20	
	148x148	€ 11,80	€ 26,40	€ 27,20	
	297x148	€ 12,90	€ 27,90	€ 29,40	
	200x200	€ 12,30	€ 27,20	€ 28,30	
	200x300	€ 13,50	€ 28,70	€ 30,40	
	300x400	€ 16,90	€ 33,40	€ 36,80	
	400x200	€ 14,60	€ 30,30	€ 32,50	
	594x420	€ 24,40	€ 43,50	€ 50,60	



Warnzeichen					
Preise für WHU-Schilder in Standardausführung bzw. ohne Beschriftung	MASSE mm	Folie	Kunststoff	Aluminium	Aufpreis f. nachleuchtende Folie
Individuelle Beschriftungen: Aufpreis pro Zeile € 10,00 Aufpreis für Standardsymbol € 15,00	100	KWHUW01F € 10,60	KWHUW01K € 24,80	KWHUW01A € 25,10	Anfrage
	200	KWHUW02F € 12,30	KWHUW02K € 27,20	KWHUW02A € 28,30	
	315	KWHUW03F € 14,60	KWHUW03K € 30,30	KWHUW03A € 32,50	
	400	KWHUW04F € 17,50	KWHUW04K € 34,20	KWHUW04A € 37,90	
	297x148	KWHUW05F € 12,90	KWHUW05K € 27,90	KWHUW05A € 29,40	
	400x200	KWHUW06F € 14,60	KWHUW06K € 30,30	KWHUW06A € 32,50	
	594x420	KWHUW07F € 24,40	KWHUW07K € 43,50	KWHUW07A € 50,60	

Verbots- und Gebotszeichen					
Preise für WHU-Schilder in Standardausführung bzw. ohne Beschriftung	MASSE mm	Folie	Kunststoff	Aluminium	Aufpreis f. nachleuchtende Folie
Individuelle Beschriftungen: Aufpreis pro Zeile € 10,00 Aufpreis für Standardsymbol € 15,00	100	KWHUG01F € 10,60	KWHUG01K € 24,80	KWHUG01A € 25,10	Anfrage
	200	KWHUG02F € 12,30	KWHUG02K € 27,20	KWHUG02A € 28,30	
	315	KWHUG03F € 14,60	KWHUG03K € 30,30	KWHUG03A € 32,50	
	400	KWHUG04F € 17,50	KWHUG04K € 34,20	KWHUG04A € 37,90	
	297x148	KWHUG05F € 12,90	KWHUG05K € 27,90	KWHUG05A € 29,40	
	400x200	KWHUG06F € 14,60	KWHUG06K € 30,30	KWHUG06A € 32,50	
	594x420	KWHUG07F € 24,40	KWHUG07K € 43,50	KWHUG07A € 50,60	



WARN-, HINWEIS- UND UNFALLVERHÜTUNGSSCHILDER

WHU-Schilder

Warn-, Hinweis- und Unfallverhütungsschilder lt. ÖNORM EN ISO 7010

Verbotszeichen













Auf folgendes Standardprogramm gelten die Grundpreise:

Die Artikelnummer setzt sich aus der Grundtafel und der laufenden Nummer zusammen!
z.B. KWHUG01FP001=WHU-Schild "P001 Allgemeines Verbotsschild" in Gr.100, nur Folie

Verbotszeichen lt. ISO 7010

P001	P002	P003	P004	P005	P006	P007	P008
							
Allgemeines Verbotsschild	Rauchen verboten	keine offene Flamme; Feuer, offene Zündquelle und Rauchen verboten	Für Fußgänger verboten	Kein Trinkwasser	Für Flurförderfahrzeuge verboten	Kein Zutritt für Personen mit Herzschrittmachern oder implantierten Defibrillatoren	Mitführen von Metallteilen oder Uhren verboten
P010	P011	P012	P013	P014	P015	P017	P018
							
Berühren verboten	Mit Wasser löschen verboten	Keine schwere Last	Eingeschaltete Mobiltelefone verboten	Kein Zutritt für Personen mit Implantaten aus Metall	Hineinfassen verboten	Schieben verboten	Sitzen verboten
P019	P020	P021	P022	P023	P024	P025	P026
							
Aufsteigen verboten	Aufzug im Brandfall nicht benutzen	Mitführen von Hunden verboten	Essen und Trinken verboten	Abstellen oder Lagern verboten	Betreten der Fläche verboten	Benutzen des unvollständigen Gerüsts verboten	Verbot, dieses Gerät in der Badewanne, Dusche oder über mit Wasser gefülltem Becken zu benutzen
P027	P028	P029	P030	P031	P032	P033	P034
							
Personenbeförderung verboten	Benutzen von Handschuhen verboten	Fotografieren verboten	Knoten von Seilen verboten	Schalten verboten	Nicht zulässig für Seitenschleifen	Nicht zulässig für Nassschleifen	Nicht zulässig für Freihand- und handgeführtes Schleifen

Verbotszeichen nach ÖNorm Z 1000-2:2002 - weiterhin gültig

AP06	AP09	AP17	AP20	AP31	AP32	AP34	AP35
							
Zutritt für Unbefugte verboten	Nicht berühren, Gehäuse unter Spannung	Mit Wasser spritzen verboten	Mitführen von magnetischen oder elektronischen Datenträgern verboten	Besteigen für Unbefugte verboten	Nicht hinter den Schwenkarm treten	Mit Hubwagen rollen verboten	Mitfahren auf Gabelstapler verboten
AP36	AP37	AP38	AP39	◇			
							
Nicht unter angegebene Last treten	Durchgang verboten	Laufen lassen von Verbrennungsmaschinen verboten	Einfahrt für flüssiggasbetriebene Kraftfahrzeuge verboten				



Individuelle Verbotsschilder - praxisbewährt

IP01	IP02	IP03	IP04	IP05	IP06	IP07	IP08
Rauchen verboten!	Rauchverbot auf dem gesamten Werksgelände	Feuer, offenes Licht und Rauchen verboten!	Kein Trinkwasser!	Unbefugten Zutritt verboten!	Für Flurförderzeuge verboten!	Mit Wasser löschen verboten!	Mobiltelefone benutzen verboten!
Aufzug im Brandfall nicht benutzen!	Abstellen oder Lagern Verboten	Es wird gearbeitet! Die Zufahrt zum Gelände ist gesperrt!	Laufenlassen von Verbrennungskraftmaschinen verboten!	Einfahrt für gasbetriebene KFZ verboten!	Rauchen verboten!	Rauchverbot im gesamten Gebäude	Feuer, offenes Licht und Rauchen verboten!
Für Fußgänger verboten!	Kein Trinkwasser	Unbefugten Zutritt verboten!	Für Flurförderzeuge verboten!	Mit Wasser löschen verboten!	Mobiltelefone benutzen verboten!	Aufzug im Brandfall nicht benutzen!	Fotografieren verboten!
Rauchen verboten!	Rauchen, Feuer und offenes Licht polizeilich verboten!	Einfahrt freihalten!	Ausfahrt freihalten!	Durchfahrt freihalten!	Durchfahrt verboten!	Zutritt verboten!	Der Zutritt für Betriebsfremde ist verboten!
Privatgrundstück Betreten verboten!	Betreten und Befahren verboten!	Privatgrundstück Parken verboten!	Plakatieren verboten!	Ballspielen verboten!	Unbefugten ist der Zutritt verboten!	Der Zutritt für Betriebsfremde ist verboten!	Betreten des Betriebsgeländes verboten!
Reinigung bei laufender Anlage verboten!	Laufenlassen der Motoren bei geschlossenen Toren verboten! Vergiftungsgefahr!	Personenbeförderung verboten!	Der Aufenthalt unter schwebenden Last ist verboten! Lebensgefahr!	Der Aufenthalt im Schwenkbereich ist verboten! Lebensgefahr!	Der Aufenthalt im Bereich des Drehkrans ist verboten!	Vorsicht! Das Verwallen unter hängenden Lasten ist verboten!	Maschinenraum Unbefugten ist der Zutritt verboten!
Schutt- und Müllablagerungen bei Strafe verboten!	Schutt abladen verboten!	Heizölagerraum Rauchen, Feuer und offenes Licht verboten!	Öllageraum Unbefugten ist der Zutritt Verboten!	Heizraum Unbefugten ist der Zutritt verboten!	Garagenanlage Rauchen, Feuer und offenes Licht polizeilich verboten!	Brunnenschutzgebiet Jede Verunreinigung verboten!	Brunnenschutzgebiet Unbefugtes Betreten und Jede Verunreinigung verboten!
Quellenschutzgebiet Jede Verunreinigung verboten!	Quellenschutzgebiet Unbefugtes Betreten und Jede Verunreinigung verboten!	◇					
Betreten der Baustelle verboten! Eltern haften für ihre Kinder!	Privatgrund Betreten verboten!	Das Betreten der Baustelle ist ohne Schutzhelm untersagt!	Privatgrund Durchgang verboten!	Betreten der Baustelle polizeilich verboten!	Unbefugten ist das Betreten der Baustelle strengstens untersagt!	ACHTUNG! BAUSTELLEN-EINFAHRT	ACHTUNG! BAUSTELLEN-AUSFAHRT
Betreten des Grundstücks verboten!	Fußgänger bitte andere Straßenseite benutzen	Vorsicht Baustelle!	Eltern haften für ihre Kinder	Achtung! Bauarbeiten	Durchgang bis auf Widerruf gestaffet		

WARN-, HINWEIS- UND UNFALLVERHÜTUNGSSCHILDER

WHU-Schilder













Warn-, Hinweis- und Unfallverhütungsschilder lt. ÖNORM EN ISO 7010

Gebotszeichen









Auf folgendes Standardprogramm gelten die Grundpreise:

Die Artikelnummer setzt sich aus der Grundtafel und der laufenden Nummer zusammen!
z.B. KWHUG01FM001=WHU-Schild "M001 Allgemeines Gebotszeichen" in Gr.100, nur Folie

Gebotszeichen lt. ISO 7010

M001	M002	M003	M004	M005	M006	M007	M008
 Allgemeines Gebotszeichen	 Anleitung beachten	 Gehörschutz benutzen	 Augenschutz benutzen	 Vor Benutzung erden	 Netzstecker ziehen	 Weitgehend lichtundurchlässigen Augenschutz benutzen	 Fußschutz benutzen
M009	M010	M011	M012	M013	M014	M015	M016
 Handschutz benutzen	 Schutzkleidung benutzen	 Hände waschen	 Handlauf benutzen	 Gesichtsschutz benutzen	 Kopfschutz benutzen	 Warnweste benutzen	 Maske benutzen
M017	M018	M019	M020	M021	M022	M023	M024
 Atemschutz benutzen	 Auffanggurt benutzen	 Schweißmaske benutzen	 Rückhaltesystem benutzen	 Vor Wartung oder Reparatur freischalten	 Hautschutzmittel benutzen	 Übergang benutzen	 Fußgängerweg benutzen
M025	M026						
 Kleinkinder durch weitgehend lichtundurchlässige Augenabschirmung schützen	 Schutzschürze benutzen						

Gebotszeichen nach ÖNorm Z 1000-2:2002 - weiterhin gültig

AM20	AM21	AM22	AM23	AM25	AM28	AM29	AM31
 Augen- und Gehörschutz tragen	 Kopf- und Gehörschutz tragen	 Augen- und Kopfschutz tragen	 Gasflasche sichern	 Für Rollstuhlbenutzer	 Rettungsweste anlegen	 Hupen	 Versperrt halten



Warnzeichen

Auf folgendes Standardprogramm gelten die Grundpreise:

Die Artikelnummer setzt sich aus der Grundtafel und der laufenden Nummer zusammen!

z.B. KWHUW01FW001=WHU-Schild "W001 Allgemeines Warnzeichen" in Gr.100, nur Folie

Warnzeichen lt. ISO 7010

W001	W002	W003	W004	W005	W006	W007	W008
Allgemeines Warnzeichen	Warnung vor explosionsgefährlichen Stoffen	Warnung vor radioaktiven Stoffen oder ionisierender Strahlung	Warnung vor Laserstrahl	Warnung vor nicht ionisierender Strahlung	Warnung vor magnetischem Feld	Warnung vor Hindernissen am Boden	Warnung vor Absturzgefahr
W009	W010	W011	W012	W013	W014	W015	W016
Warnung vor Biogefährdung	Warnung vor niedriger Temperatur/Frost	Warnung vor Rutschgefahr	Warnung vor elektrischer Spannung	Warnung vor Wachhund	Warnung vor Flurförderzeugen	Warnung vor schwebender Last	Warnung vor giftigen Stoffen
W017	W018	W019	W020	W021	W022	W023	W024
Warnung vor heißer Oberfläche	Warnung vor automatischem Anlauf	Warnung vor Quetschgefahr	Warnung vor Hindernissen im Kopfbereich	Warnung vor feuergefährlichen Stoffen	Warnung vor spitzem Gegenstand	Warnung vor ätzenden Stoffen	Warnung vor Handverletzungen
W025	W026	W027	W028	W029	▽		
Warnung vor gegenläufigen Rollen	Warnung vor Gefahren durch das Aufladen von Batterien	Warnung vor optischer Strahlung	Warnung vor brandfördernden Stoffen	Warnung vor Gasflaschen			

Warnzeichen nach ÖNorm Z 1000-2:2002 - weiterhin gültig

AW18	AW22	AW30	AW31	AW32	○	◻
Warnung vor schädlichen oder irritierenden (reizenden) Stoffen	Warnung vor Fräswelle	Warnung vor Engstelle	Warnung vor Treppe	Warnung vor Gefahr des Einzugs		

Individuelle Warnschilder - praxisbewährt

IW01	IW02	IW03	IW04
Achtung Hochspannung Lebensgefahr	Achtung Hochspannung Lebensgefahr	Achtung Automatischer Warentransport Gefahrenschmelze Zone nicht betreten!	Vorsicht! Explosionsfähige Atmosphäre



Brandschutzzeichen

Auf folgendes Standardprogramm gelten die Grundpreise:
Die Artikelnummer setzt sich aus der Grundtafel und der laufenden Nummer zusammen!
z.B. KWHUE01FF001=WHU-Schild "F001 Feuerlöscher" in Gr. 100x100, nur Folie

Brandschutzzeichen lt. ISO 7010

F001	F002	F003	F004	F005	F006
					
Feuerlöscher	Löschschlauch	Feuerleiter	Mittel und Geräte zur Brandbekämpfung	Brandmelder	Brandmeldetelefon

Brandschutzzeichen nach ÖNorm Z 1000-2:2002

AF05	AF07
	
Richtungsanzeige (nur in Verbindung mit einem anderen Rettungszeichen)	Richtungsanzeige (nur in Verbindung mit einem anderen Rettungszeichen)

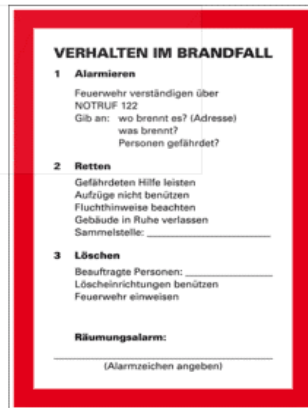

Hinweiszeichen "Verhalten im Brandfall"

















WHU-Schilder

Warn-, Hinweis- und Unfallverhütungsschilder lt. ÖNORM EN ISO 7010













Rettungszeichen

Auf folgendes Standardprogramm gelten die Grundpreise:
Die Artikelnummer setzt sich aus der Grundtafel und der laufenden Nummer zusammen!
z.B. KWHUE01FE001=WHU-Schild "Notausgang links" in Gr.100x100, nur Folie





















Rettungszeichen lt. ISO 7010

E001  Notausgang (links)	E002  Notausgang (rechts)	E003  Erste Hilfe	E004  Notruftelefon	E007  Sammelstelle	E008  Notausgangsvorrichtung, die nach Zerschlagen einer Scheibe zu erreichen ist	E009  Arzt	E010  Automatisierter externe Defibrillator (AED)
E011  Augenspüle	E012  Notdusche	E013  Krankentrage	E016  Notausstieg mit Fluchtleiter	E017  Rettungsausstieg	E018  Öffnung durch Linksdrehung	E019  Öffnung durch Rechtsdrehung	

Rettungszeichen nach ÖNorm Z 1000-2:2002

AE01  Rettungsweg - Notausgang (rechts oder links)	AE03  Rettungsweg - Notausgang	AE02  Rettungsweg - Notausgang	AE04  Rettungsweg - Notausgang (rechts oder links)	AE05  Rettungsweg - Notausgang	AE13  Richtungsanzeige (nur in Verbindung mit einem anderen Rettungszeichen)	AE14  Richtungsanzeige (nur in Verbindung mit einem anderen Rettungszeichen)	AE18  Fluchthaube
AE20  Rettungsweg - Notausgang für Behinderte (links oder rechts)	AE21  Rettungsweg - Notausgang, aufwärts (links oder rechts)	AE22  Rettungsweg - Notausgang, abwärts (links oder rechts)					

Individuelle Rettungsschilder - praxisbewährt

IE01  Notausgang	IE02  Notausgang	IE03  Notausgang	IE04  Notausgang	IE05  Notausgang	IE06  Notausgang	IE07  Rettungsweg	IE08  Notausgang
IE09  Notausstieg	IE10  Notleiter	IE11  Notrutsche	IE12  Ausgang	IE13  Eingang	IE14  Richtungspfeil	IE15  Rettungsleiter	IE16  Verbandskasten
IE17  Sanitätsraum	IE18  Krankentrage	IE19  Notausgang freihalten	IE20  Notausgang alarmgesichert				

Individuelle Warn- und Hinweisschilder, Winkel- und Fahnschilder auf Anfrage!

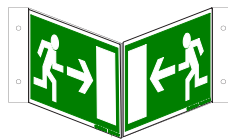

SONSTIGES

Sonstige Beschilderung

Rad-, Fuß-, Fitness- und sonstige Beschilderung

Individuelle Radwegsbeschilderung



Nordic Walking und sonstige Fitness-Beschilderung

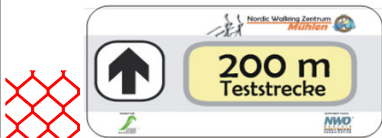

Individuelle Wanderwegsbeschilderung

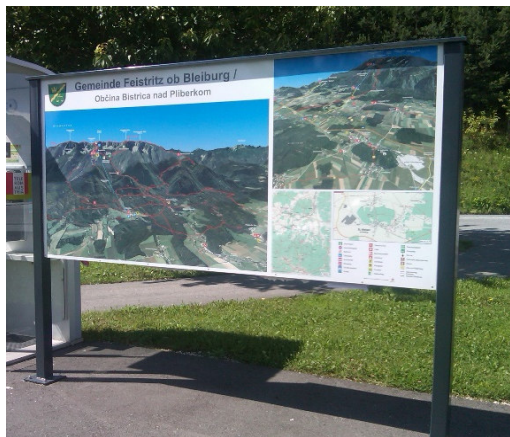

Ausführung: Cortenstahl

Waldheimhütte	1h 45min	320
Rothaidenhütte	1h	320/46
Köhlerhütte	1h	320/45

Innenbeschilderung

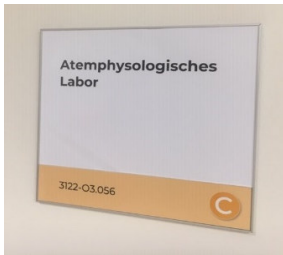

Wegweiser 5.OG

	Sektor
Zentrumsmanagement Pflege	E
Zentrumsmanagement Sekretariat	E
Konferenzraum "Wintergarten"	E



SONSTIGES

Sonstige Beschilderung

Aussenbeschilderung / Pylone



Aussenbeschilderung / Pylone



SONSTIGES

Sonstige Beschilderung

Aussenbeschilderung

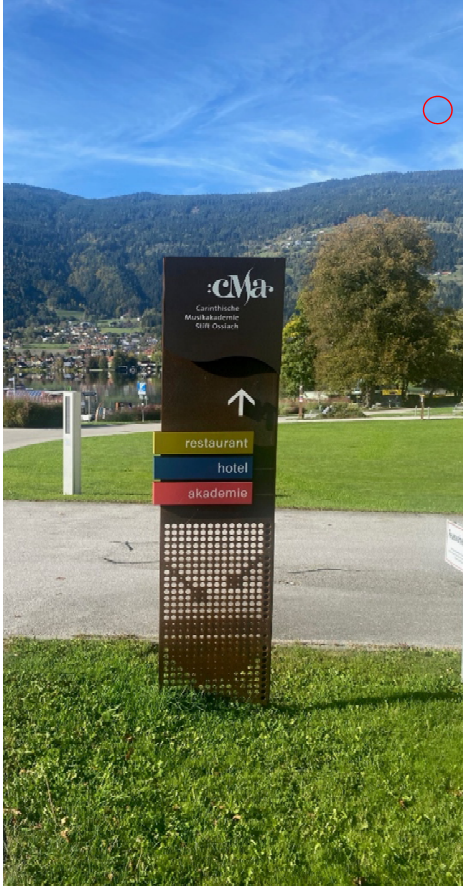

Panoramaskilder, sonstige Informationsschilder



SONSTIGES

Sonstige Beschilderung

Panoramaschilder, sonstige Informationsschilder

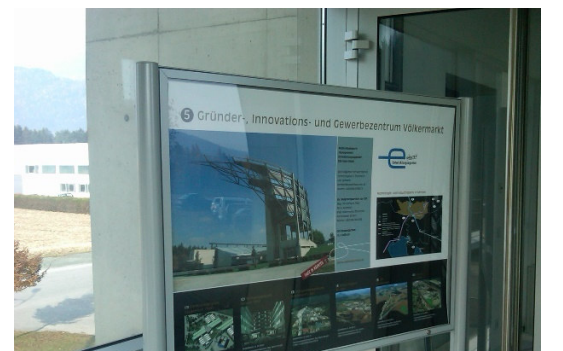
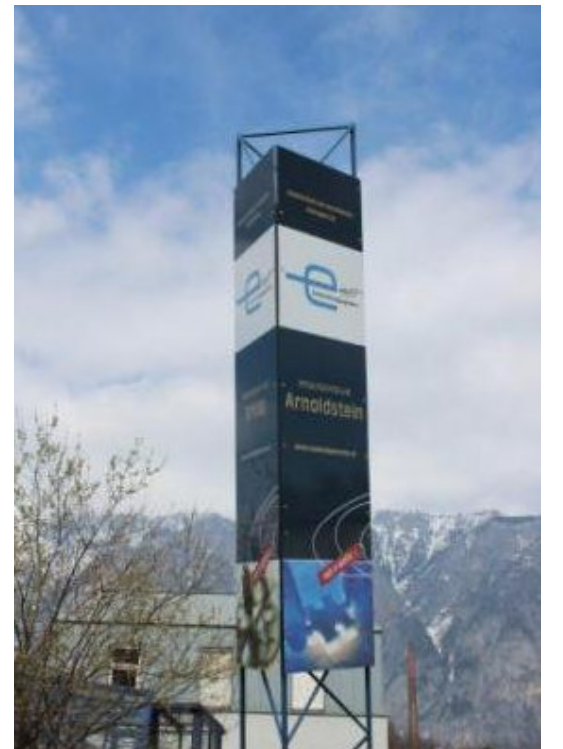

sonstige Informationsschilder



Sonstige Beschriftungen

Gebäudebeschriftung



Glasbeschriftung

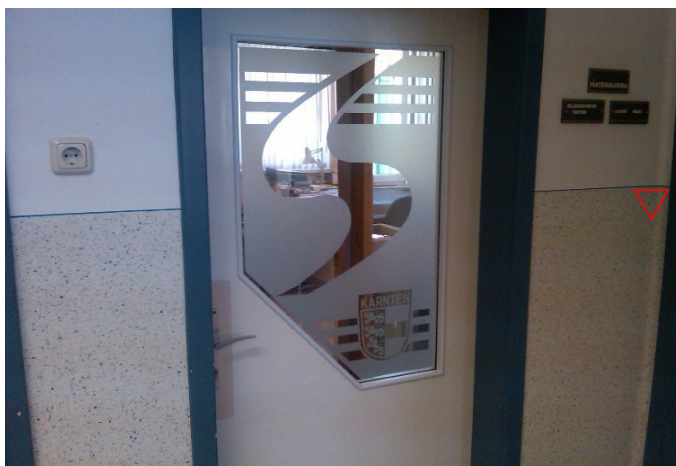

Autobeschriftung



Plane mit Spannrahmen



Blindenleitsysteme



ALLGEMEINE GESCHÄFTSBEDINGUNGEN

Verkaufs- und Lieferbedingungen



01. ALLGEMEINES

Für alle uns erteilten Aufträge gelten nachstehende Bedingungen als vereinbarter Vertragsbestandteil. Änderungen und Ergänzungen sowie abweichende Bestellbedingungen des Auftraggebers gelten nur nach unserer schriftlichen Bestätigung.

02. KOSTENVORANSCHLÄGE/RECHNUNGSLEGUNG

Kostenvoranschläge werden von uns ohne Gewähr gegeben und sind unverbindlich.
Rechnungen werden in digitaler Form oder per Post verschickt.

03. PREISE

Alle Preise verstehen sich in Euro, soweit nicht anderes vereinbart wurde, ab Werk, plus Mehrwertsteuer. Mehrkosten aufgrund besonderer Versandarten (Expressgut, Luftfracht, Eilbotensendungen usw.) gehen zu Lasten des Käufers.

Wir behalten uns Preisänderungen bis zum Tage der Lieferung/Leistung vor.

Bei einem Nettofakturawert unter € 150,00 bringen wir Manipulationsspesen zur Anrechnung.

04. LIEFER- UND LEISTUNGSFRISTEN

Die Lieferfristen beginnen mit Klärung aller für die Auftragsausführung notwendigen Punkte. Angegebene Liefertermine verstehen sich stets voraussichtlich und sind unverbindlich.

Behinderungen aller Art, die abzuwenden nicht in unserer Macht liegen oder uns nicht zumutbar sind, entbinden uns von der Einhaltung der eingegangenen Verpflichtungen während deren Dauer und auch hinsichtlich deren Folgen und verlängern die Ausführungsfristen entsprechend.

Auch bei vereinbarten Lieferfristen haften wir nicht für Verzögerungen, welche durch unvorhergesehene Vorgänge bei der Fabrikation, bei der Beförderung, bei Störungen im Produktionsbetrieb bzw. bei Unterlieferanten oder durch höhere Gewalt eintreten. Derartige Umstände berechtigen uns, bei längerer Dauer einseitig vom Vertrag zurückzutreten, ohne dass dem Käufer aus diesem Grunde irgendein Schadenersatzanspruch gegen uns zusteht.

Aus dem Grunde der Überschreitung von Lieferfristen sind wir gegenüber dem Käufer zu keinem Schadenersatz verpflichtet.

Mängelrügen müssen innerhalb von 3 Werktagen bekannt gegeben werden.

05. LIEFERUNG

Die Lieferung und der Versand der Ware erfolgt stets auf Rechnung und Gefahr des Käufers ab unserem Auslieferungslager. Die Versandart wird von uns festgelegt.

06. GEWÄHRLEISTUNG

Wir anerkennen nur Mängelrügen, die nach Ablieferung/Erbringung der Leistung innerhalb von 3 Tagen erhoben und spätestens 5 Tagen schriftlich angezeigt wurden.

Dabei steht es uns frei, entweder die fehlerhaften Teile zum berechneten Wert zurückzunehmen oder durch mängelfreie zu ersetzen, wobei Ersatzlieferungen stets ab Werk gegen Verrechnung des aktuellen Tagespreises erfolgen. Vom Auftraggeber in Nutzung genommene, nachgearbeitete oder geänderte Teile werden weder zurückgenommen noch ersetzt.

Transportschäden müssen unverzüglich bei Warenübernahme in geeigneter Form festgehalten und schriftlich gemeldet werden.

Rücksendungen können nur nach vorheriger schriftlicher Vereinbarung angenommen werden. Bei Rücksendungen, die nicht auf einen der erwähnten Beanstandungsgründe zurückzuführen sind, reduzieren wir den Gutschriftswert um einen Bearbeitungsbetrag von 20 % des Nettokaufpreises.



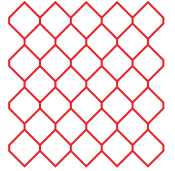

07. SCHADENERSATZ

Wir haften nicht für leichte Fahrlässigkeit. Weiters wird die Haftung für Sachschäden im Sinne des Produkthaftungsgesetzes, die der Auftraggeber als Unternehmer erleidet, ausgeschlossen. Folgeschäden und mittelbare Kosten werden nicht ersetzt.

08. ZAHLUNG UND EIGENTUMSVORBEHALT

Grundsätzlich haben alle Zahlungen an uns durch Überweisung auf unser im Rechnungsformular angegebenes Konto zu erfolgen.

Bei Überschreitung einer Zahlungsfrist kommt der Käufer auch ohne Mahnung in Verzug und etwaige weitere zu diesem Zeitpunkt noch nicht fällige Forderungen gegen den Käufer werden ohne jeden Abzug zur sofortigen Zahlung fällig.

Unsere Forderungen gegen den Käufer werden weiters sofort ohne jeden Abzug zur Zahlung fällig, wenn die Einleitung eines Konkurs- oder Ausgleichsverfahrens über das Vermögen des Käufers beantragt oder ein derartiges Verfahren eröffnet wird oder wenn der Käufer seine Zahlungen faktisch einstellt. In diesen Fällen sind wir auch berechtigt, von den laufenden Lieferverträgen zurückzutreten. Unser Recht, Schadenersatz wegen Nichterfüllung zu verlangen, bleibt vorbehalten.

Bei Zahlungsverzug sind wir berechtigt, ab dem Fälligkeitstag - unbeschadet aller übrigen uns wegen des Verzuges zustehenden Rechte - Verzugszinsen in Höhe von 12 % p.a. zu berechnen.

Gelieferte Ware bleibt bis zur vollständigen Bezahlung unser Eigentum. Wir sind berechtigt, die sofortige Herausgabe der gelieferten, aber noch nicht vollständig bezahlten Ware zu verlangen, wenn der Käufer seinen Zahlungsverpflichtungen uns gegenüber nicht pünktlich nachkommt oder über das Vermögen des Käufers ein Konkurs- oder Ausgleichsverfahren beantragt oder eröffnet wird. Bei Weiterveräußerung gilt die Kaufpreisforderung ohne besondere Vereinbarung als an uns abgetreten.

Dem Käufer steht kein Zurückhaltungsrecht zu und er ist auch nicht zur Aufrechnung berechtigt. Insbesondere darf der Käufer die Bezahlung des Kaufpreises wegen eventuell erhobener Mängelrügen nicht verweigern oder verzögern.

09. ERFÜLLUNGORT/GERICHTSSTAND

Erfüllungsort für Lieferung und Zahlung sowie für sämtliche Verpflichtungen des Käufers uns gegenüber ist für beide Teile Grafenstein.

Für alle eventuellen aus oder im Zusammenhang mit dem gegenständlichen Geschäft entstehenden Rechtsstreitigkeiten wird die örtliche Zuständigkeit des Landes- oder Bezirksgerichts Klagenfurt vereinbart.

10. ALLGEMEINES

Änderungen von Preisen, Ausführungen, Texten und Symbolen, insbesondere zur Anpassung an Änderungen bei Gesetzen und Normen sowie sonstigen Vorschriften, vorbehalten.

Wenn keine anderen Angaben erfolgen, beziehen sich die angegebenen Paragraphen auf die STVO. Es gelten Toleranzen nach entsprechenden Normen und die branchenüblichen Usancen.

Nachdrucke, auch teil- und auszugsweise, verboten!

Mit Erscheinen dieses Kataloges verlieren alle vorherigen Kataloge ihre Gültigkeit.

IMPRESSUM

Verfasser: Karl Kaltenhauser, geschäftsführender Gesellschafter •

Elke Kaltenhauser, geschäftsführende Gesellschafterin

Medieninhaber: ITEK Verkehrs- und Beschilderungstechnik GmbH

• St. Peter 33 • A-9131 Grafenstein • Telefon: 0043 (0) 4225 2569 •

Fax: 0043 (0) 4225 2569 - 14 • E-Mail: office@itek.co.at

Layout: ITEK, Agentur im Park. Fotos: ITEK, gleissfoto.at, stock.

adobe.com/leeyjutung. Druck: Druckerei Janetschek GmbH.

Herstellungsort: 3860 Heidenrichsti. Stand September 2024



Dieser Katalog wurde mit der gebotenen Sorgfalt gestaltet. Trotzdem können Satz- und Druckfehler nicht ausgeschlossen werden. ITEK übernimmt für allfällige solche Fehler keine Haftung.

QUALITÄTS- UND UMWELT- MANAGEMENT MIT SYSTEM.

Um flexibel auf die sich ständig ändernden Anforderungen im globalen Wettbewerb reagieren zu können, Prozesse effizient zu gestalten und vor allem unsere Kunden in den Mittelpunkt sämtlicher Überlegungen zu stellen, bedarf es eines nachhaltigen Qualitätsmanagementsystems.

Die folgenden Zertifizierungen garantieren Ihnen höchste Transparenz, maximale Sicherheit und Kundenzufriedenheit.



ISO 9001

Die Basis für den kontinuierlichen Verbesserungsprozess unseres Qualitätsmanagementsystems. Laufende Qualitätskontrollen, interne und externe Audits garantieren die Einhaltung der Qualitätsziele als qualitätsbewusster Produzent



UMWELT

Da uns Umweltschutz sehr am Herzen liegt, haben wir uns nach dem EFK - Energieforum Kärnten - und der EMAS - Eco-Management and Audit Scheme - zertifizieren lassen.

Dies gewährleistet Ihnen, dass wir nicht nur Umweltschutz sehr Ernst nehmen, sondern auch die gesellschaftliche Verantwortung dafür zeigen.



ÖNORM EN 12899

Als zertifizierter Verkehrszeichenhersteller haben Sie bei ITEK die Sicherheit, dass wir nur jene Produkte einsetzen, die den geltenden gesetzlichen Normen und Richtlinien entsprechen.

1. ÖNORM EN 12899-1
2. StVZO 1998 BGBl 238/1998
3. insbesondere RVS 05.02.15, 05.02.12, 05.02.13, 08.23.01 und 08.31.02



WEITERS GARANTIEREN WIR SICHERHEIT BEZÜGLICH:

1. Verwendung zertifizierter Materialien, Folien, Farben und Laminate.
2. Erstprüfung des Produktes (Verkehrszeichen, Befestigung und Steher).
3. Laufende Qualitätskontrolle.
4. Regelmäßige Fremdüberwachung der Verkehrszeichenproduktion durch den TÜV Österreich.



MCS PARTNER

Als zertifizierter 3M-Partner gewähren wir auf Digitaldrucke im Verkehrszeichenbereich bis zu 5 Jahre MCS-Garantie.



EN 1090

Dass wir nach EN1090 EXC 2 geprüft und zertifiziert sind, gibt Ihnen die Sicherheit, dass alle unsere geschweißten Artikel den gesetzlichen Regelungen und Normen entsprechen.

**ITEK VERKEHRS- UND
BESCHILDERUNGSTECHNIK GMBH**

**St. Peter 33
9131 Grafenstein
Austria**

**+43 4225/25 69
office@itek.co.at
www.itek.co.at**